



US00D627922S

(12) **United States Design Patent**
Carvalho et al.

(10) **Patent No.:** **US D627,922 S**
(45) **Date of Patent:** **** Nov. 23, 2010**

(54) **BATH SOAP**

(75) Inventors: **André Luis Brasilino de Carvalho**, São Bernado do Campo SP (BR); **Pedro de Sá Brasil Horigoshi**, São Paulo SP (BR); **Luna Menina Gonçalves Weyel**, São Paulo SP (BR); **Melissa Ferraz Barbosa**, São Paulo SP (BR); **Gustavo Senna Chelles**, São Paulo SP (BR)

(73) Assignee: **Natura Cosméticos S.A.**, Itapeceirica da Serra, SP (BR)

(**) Term: **14 Years**

(21) Appl. No.: **29/336,778**

(22) Filed: **May 8, 2009**

(30) **Foreign Application Priority Data**

Nov. 12, 2008 (BR) DI6804962

(51) **LOC (9) Cl.** **28-02**

(52) **U.S. Cl.** **D28/8.1**

(58) **Field of Classification Search** D28/4,
D28/8.1–8.2; D24/100–103; 510/133, 141–148,
510/440, 447–450

See application file for complete search history.

(56) **References Cited**

U.S. PATENT DOCUMENTS

D124,755 S *	1/1941	Voorhis	D28/8.1
D138,687 S *	8/1944	Werner et al.	D28/8.1
D206,140 S *	11/1966	Meeker	D28/8.1
D216,307 S *	12/1969	Ninger	D24/103
D243,119 S *	1/1977	Mitchell	D28/8.1
D613,454 S *	4/2010	Carvalho et al.	D28/8.1

* cited by examiner

Primary Examiner—Jennifer Rivard

(74) *Attorney, Agent, or Firm*—B. Aaron Schulman; Stites & Harbison PLLC

(57) **CLAIM**

The ornamental design for a bath soap, as shown and described.

DESCRIPTION

FIG. 1 is a perspective front and right view showing the new design for the bath soap.

FIG. 2 is a front view thereof.

FIG. 3 is a side view thereof, the opposite view being a mirror image.

FIG. 4 is a top view thereof, the bottom view being a mirror image.

FIG. 5 is a perspective front and right view showing an alternative embodiment of the new design for the bath soap.

FIG. 6 is a front view thereof.

FIG. 7 is a side view thereof, the opposite view being a mirror image.

FIG. 8 is a top view thereof, the bottom view being a mirror image.

FIG. 9 is a perspective front and right view showing an alternative embodiment of the new design for the bath soap.

FIG. 10 is a front view thereof.

FIG. 11 is a side view thereof, the opposite view being a mirror image.

FIG. 12 is a top view thereof, the bottom view being a mirror image.

FIG. 13 is a perspective front and right view showing an alternative embodiment of the new design for the bath soap.

FIG. 14 is a front view thereof.

FIG. 15 is a side view thereof, the opposite view being a mirror image.

FIG. 16 is a top view thereof, the bottom view being a mirror image.

FIG. 17 is a perspective front and right view showing an alternative embodiment of the new design for the bath soap.

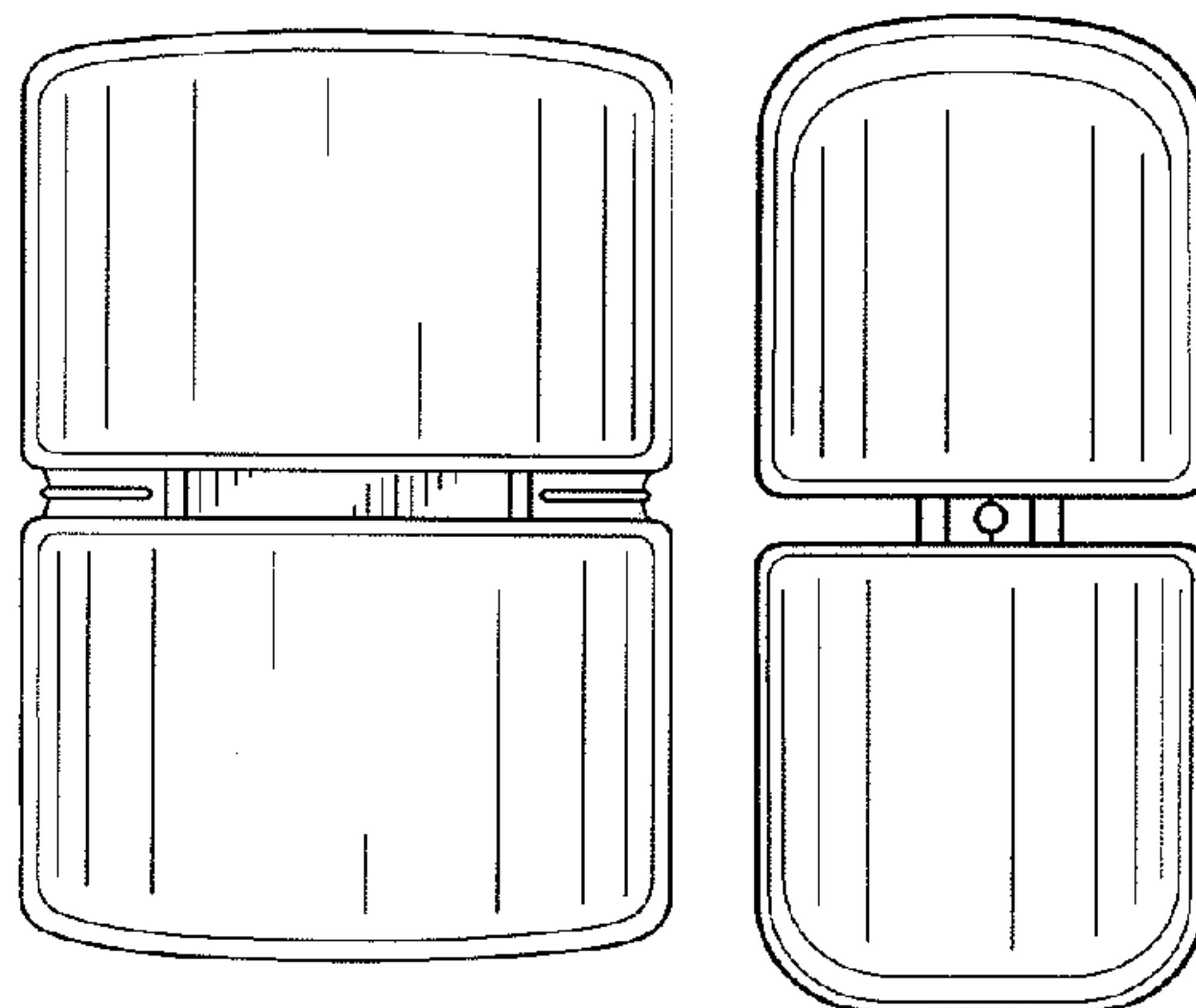

FIG. **18** is a front view thereof.

FIG. **19** is a top view thereof, the bottom view being a mirror image.

FIG. **20** is a side view thereof, the opposite view being a mirror image.

FIG. **21** is a perspective front and right view showing an alternative embodiment of the new design for the bath soap.

FIG. **22** is a front view thereof.

FIG. **23** is a side view thereof, the opposite view being a mirror image.

FIG. **24** is a top view thereof, the bottom view being a mirror image.

FIG. **25** is a perspective front and right view showing an alternative embodiment of the new design for the bath soap.

FIG. **26** is a front view thereof.

FIG. **27** is a side view thereof, the opposite view being a mirror image; and,

FIG. **28** is a top view thereof, the bottom view being a mirror image.

1 Claim, 14 Drawing Sheets

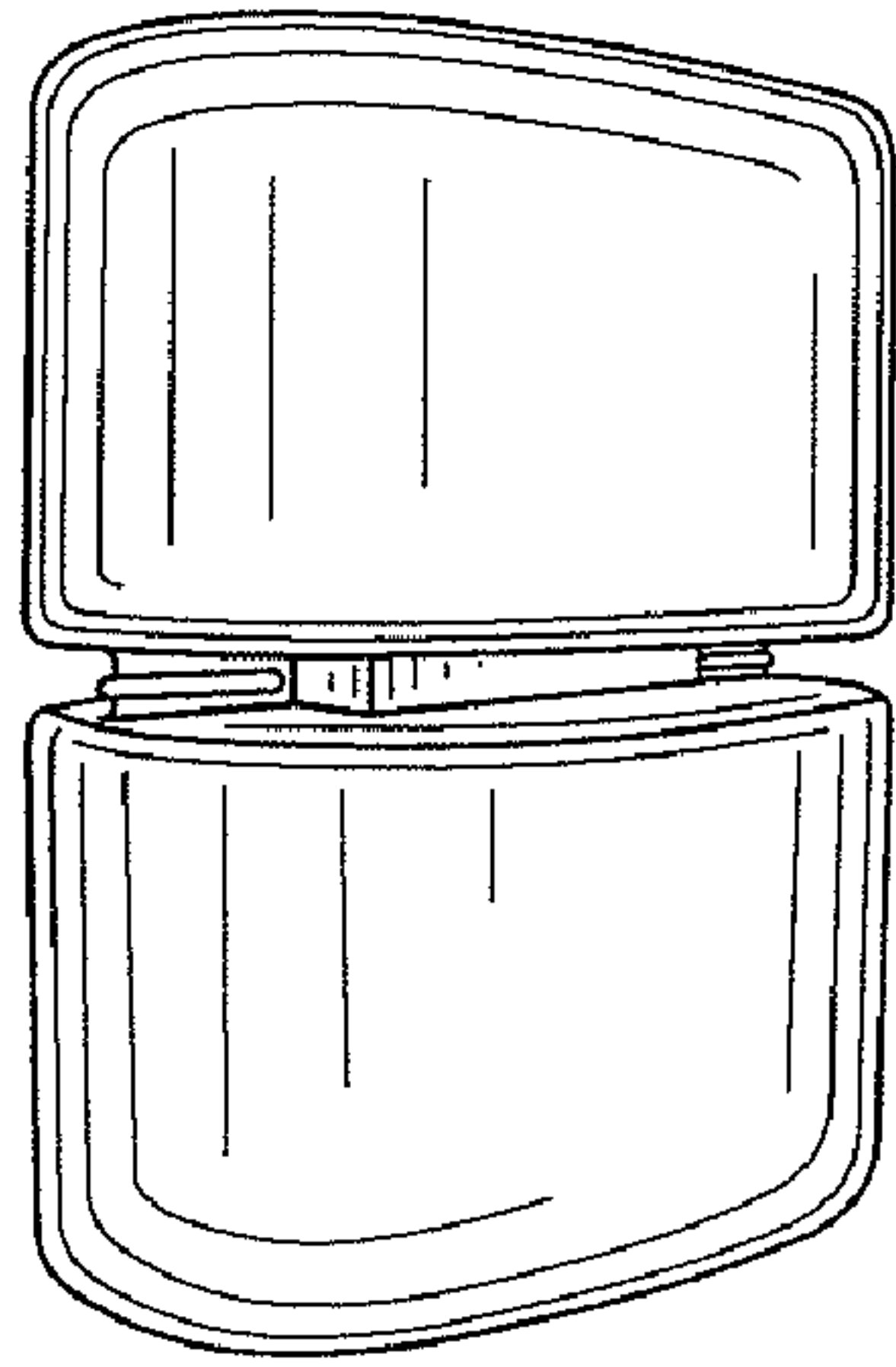

Fig. 1

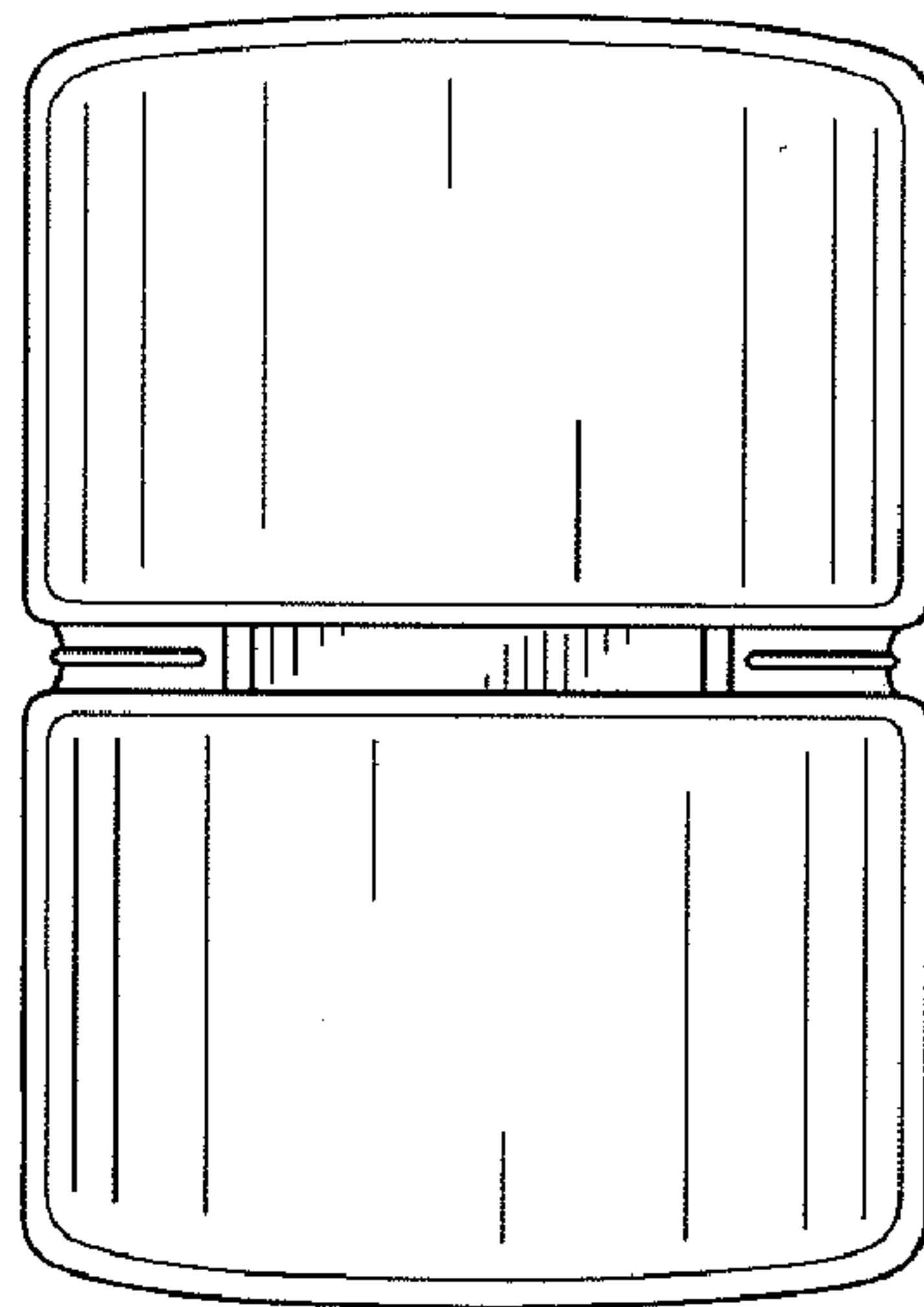

Fig. 2

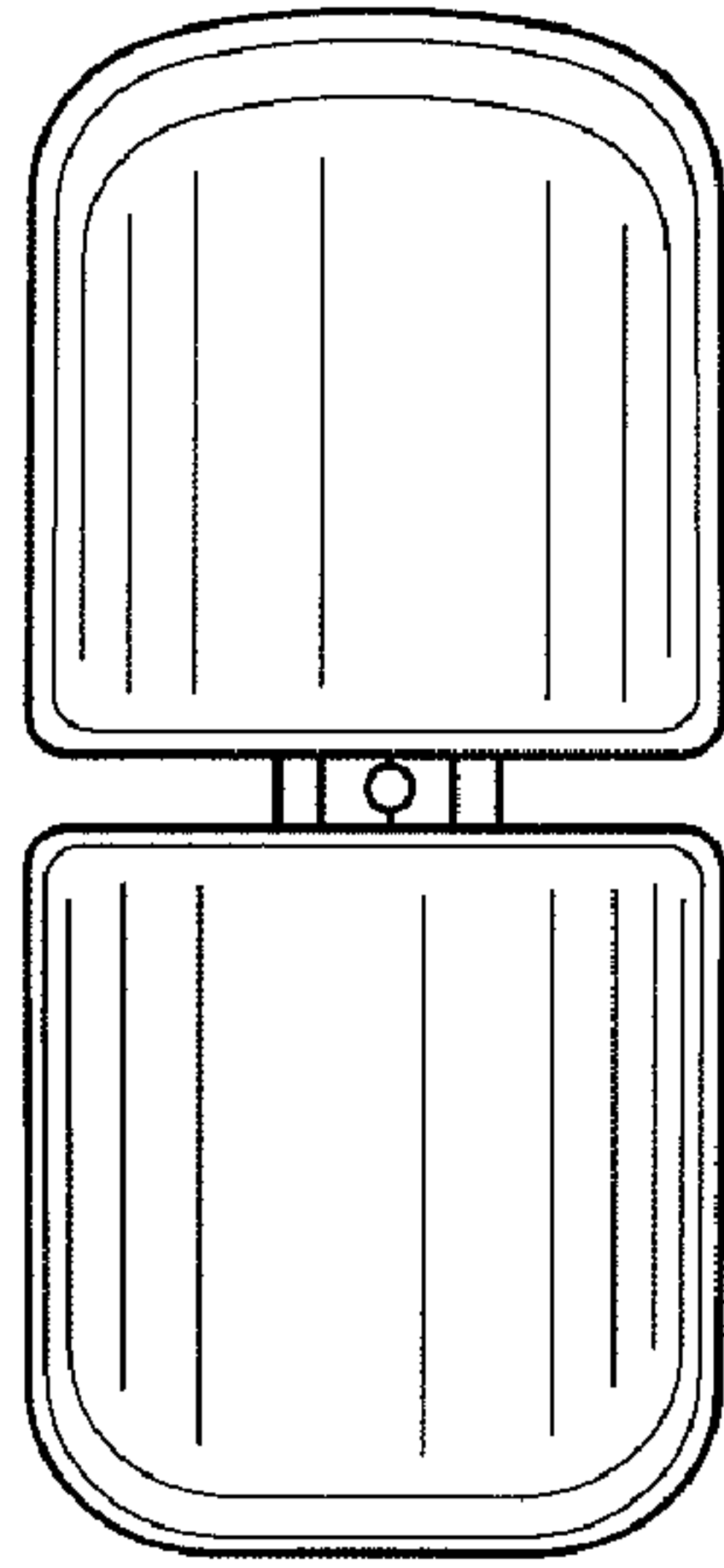

Fig. 3

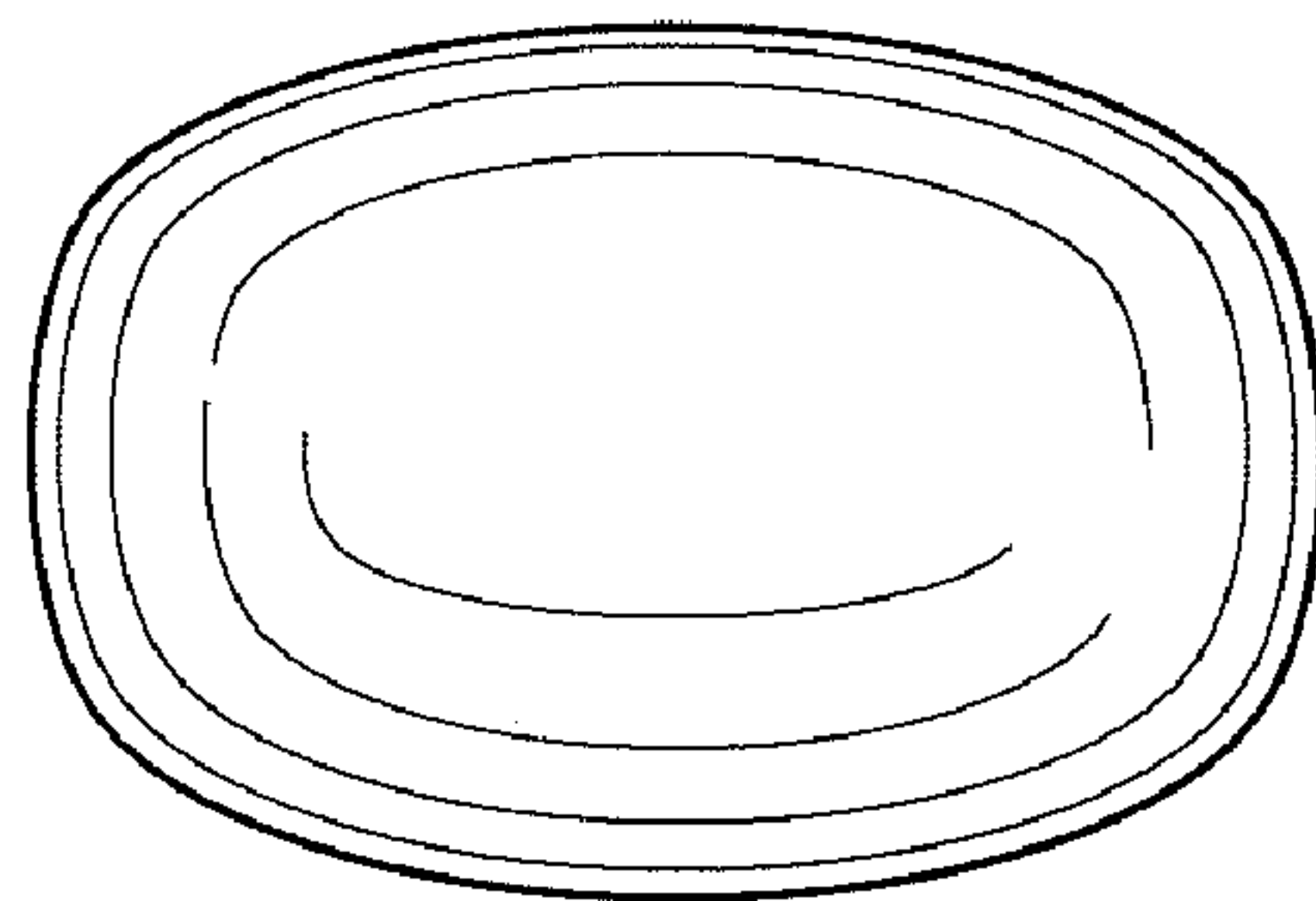

Fig. 4

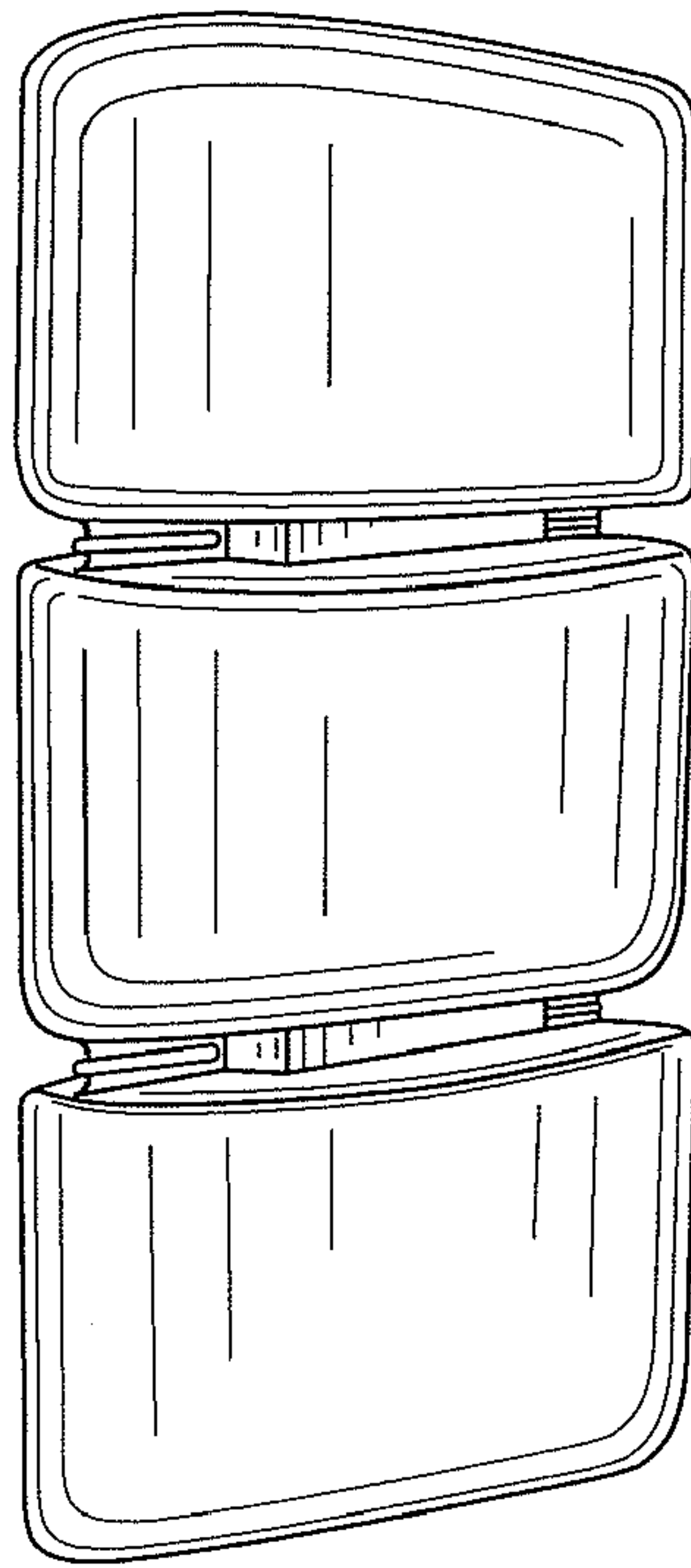

Fig. 5

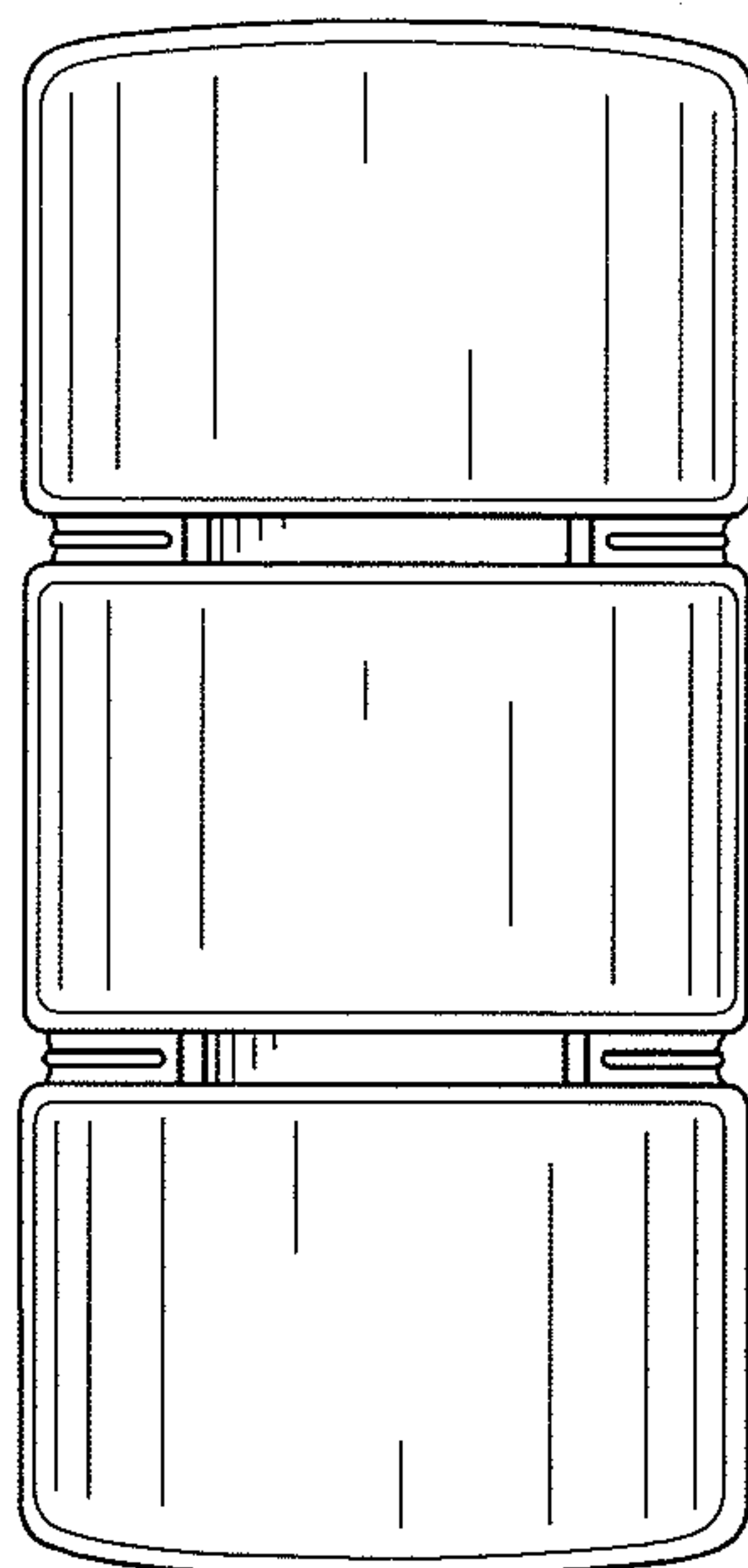

Fig. 6

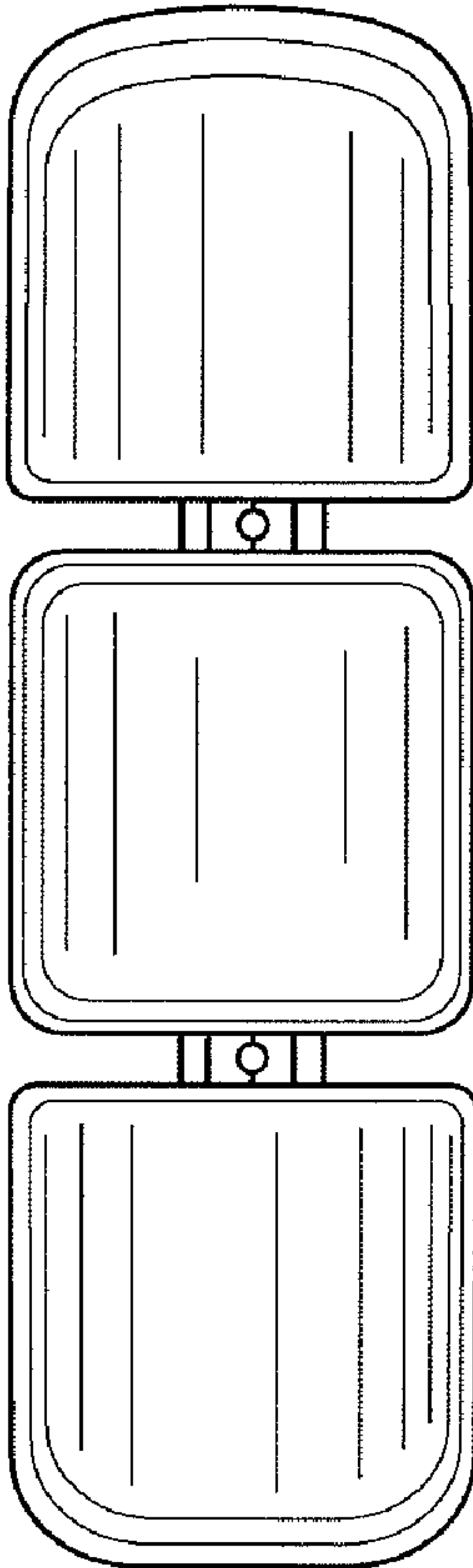

Fig. 7

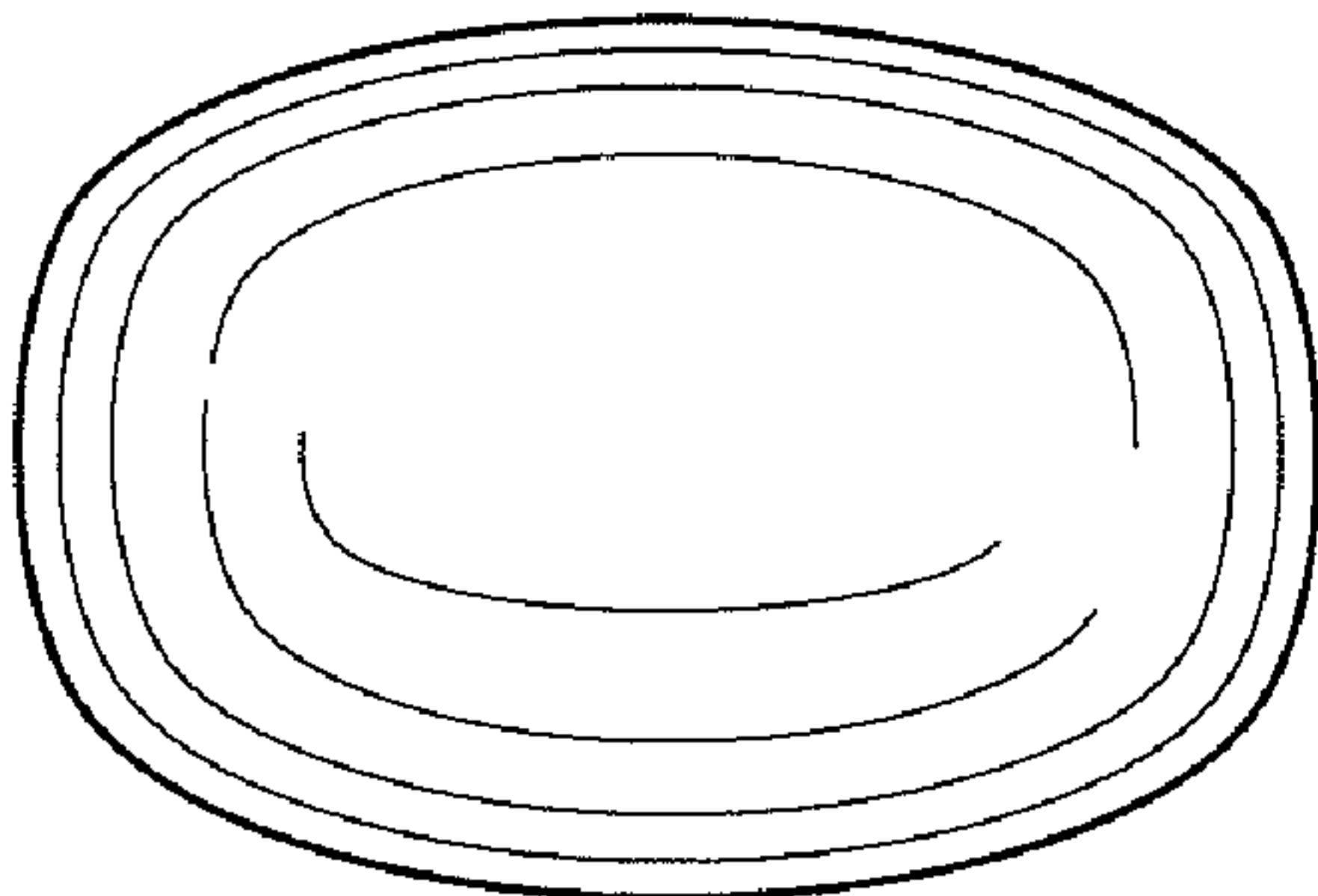

Fig. 8

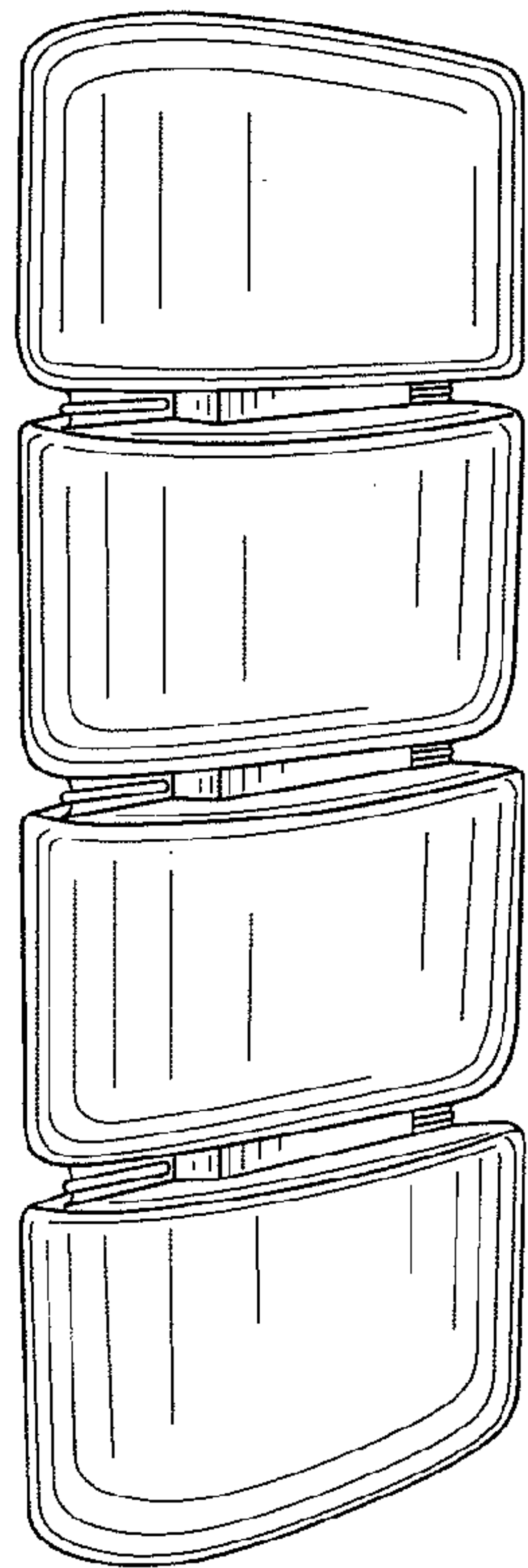

Fig. 9

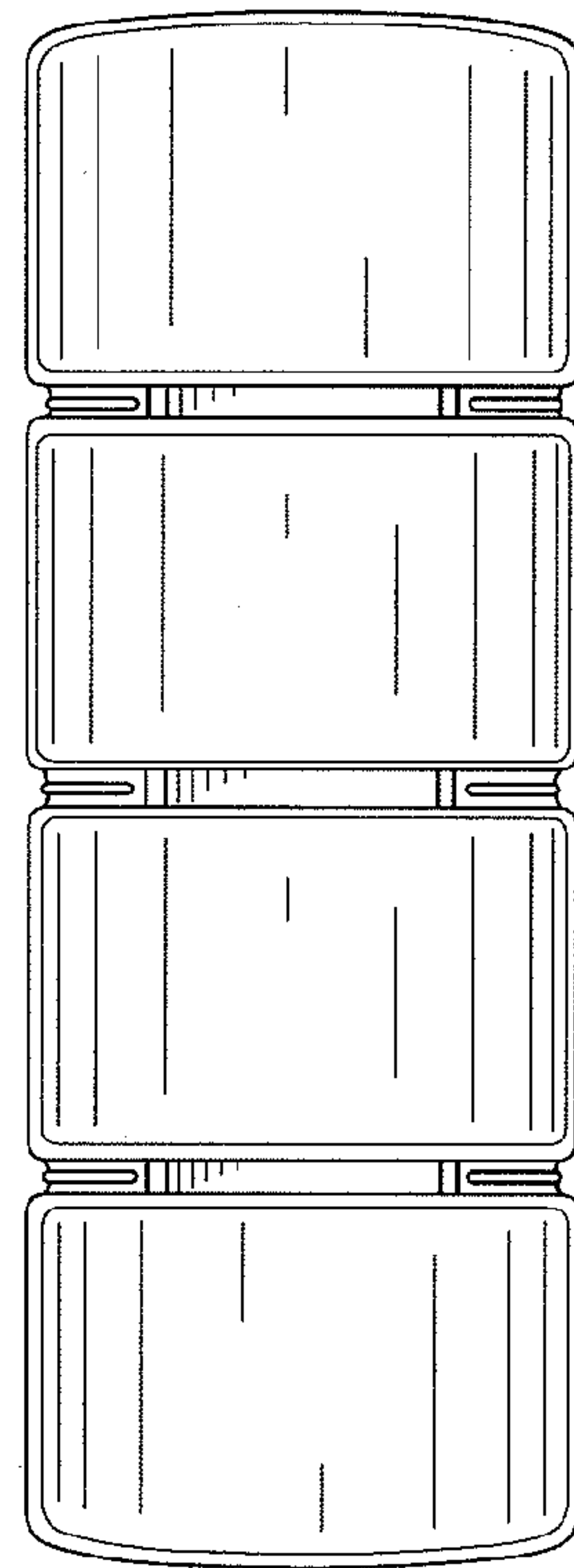

Fig. 10

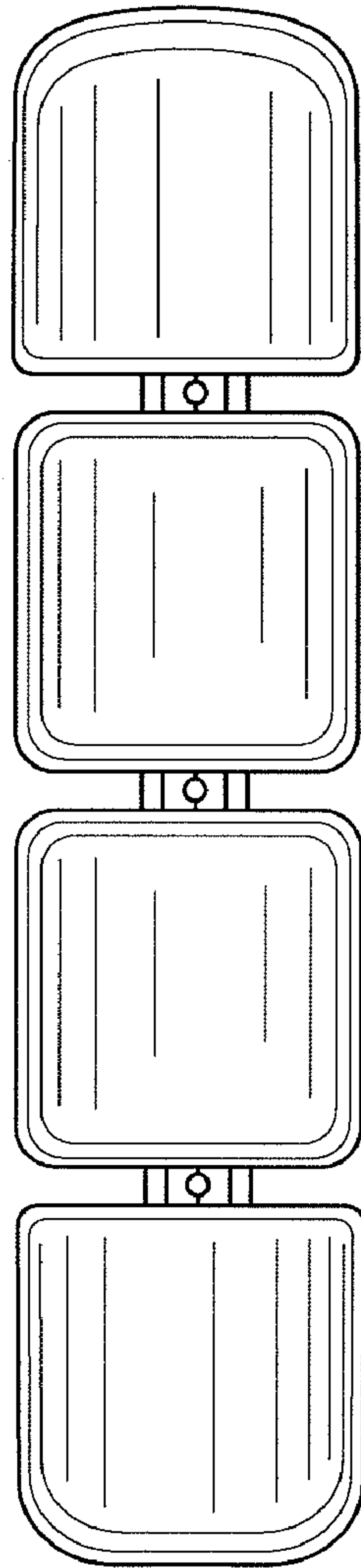

Fig. 11

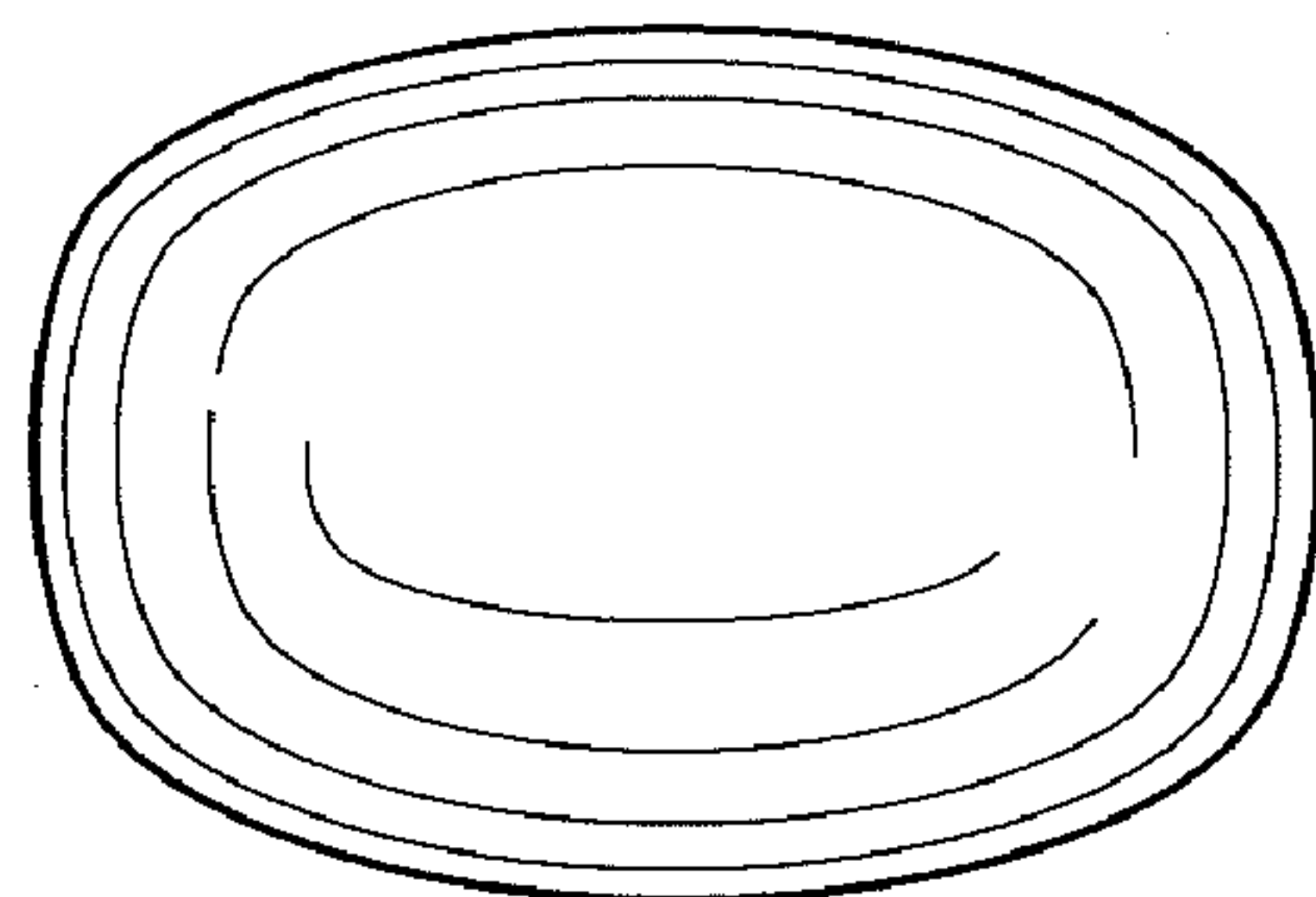

Fig. 12

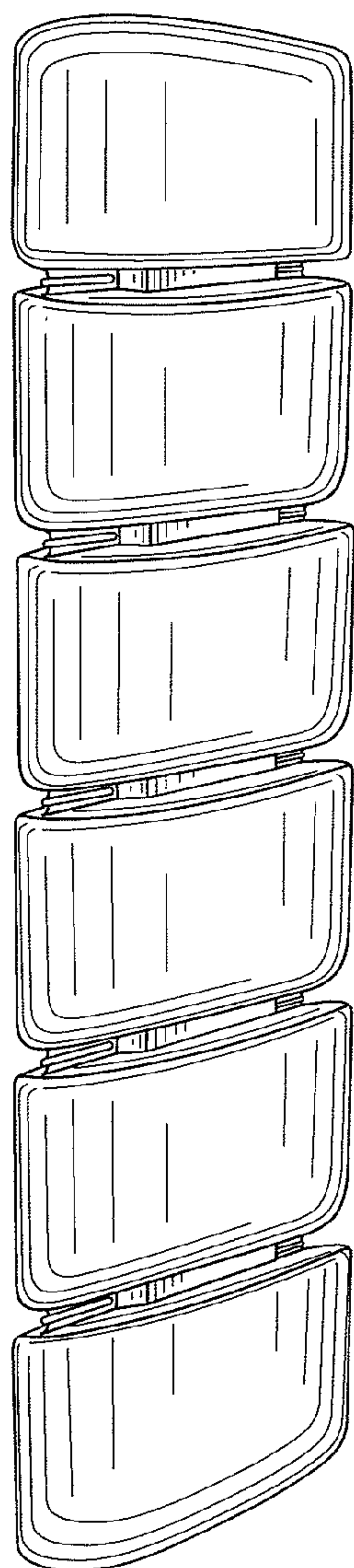

Fig. 13

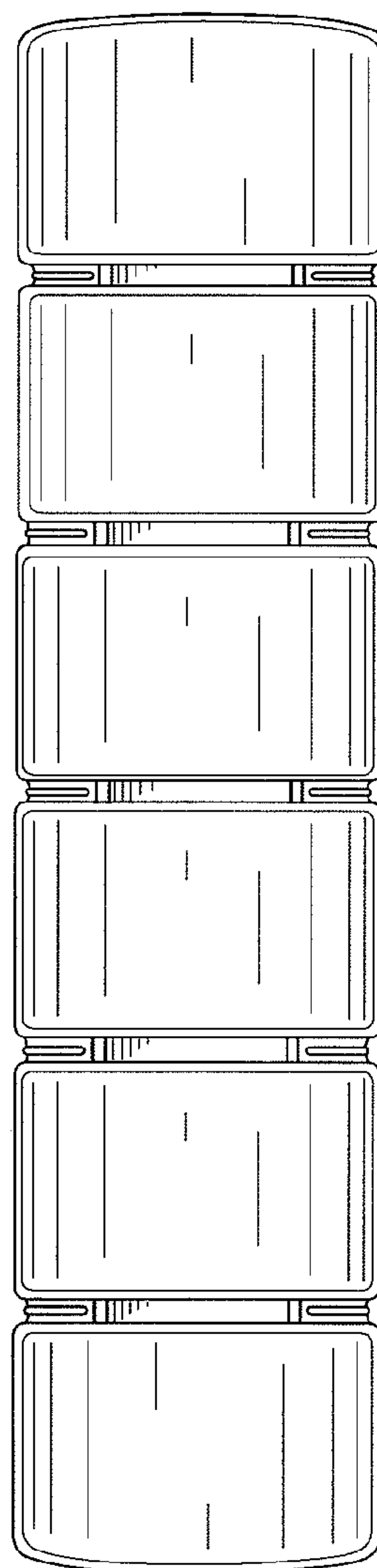

Fig. 14

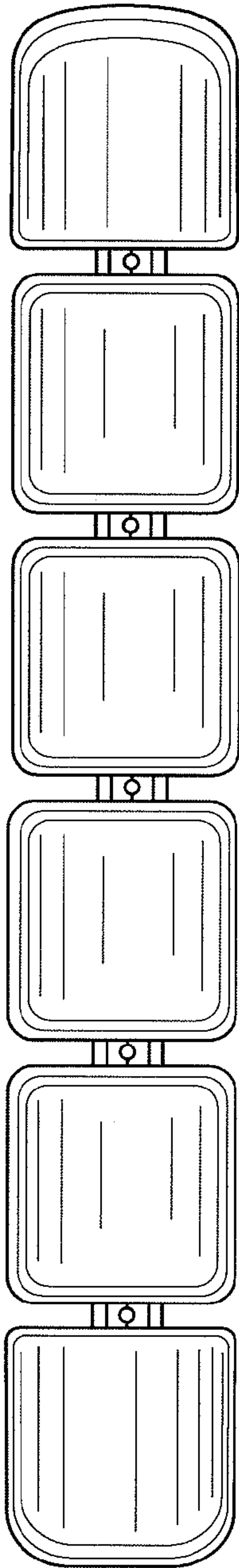

Fig. 15

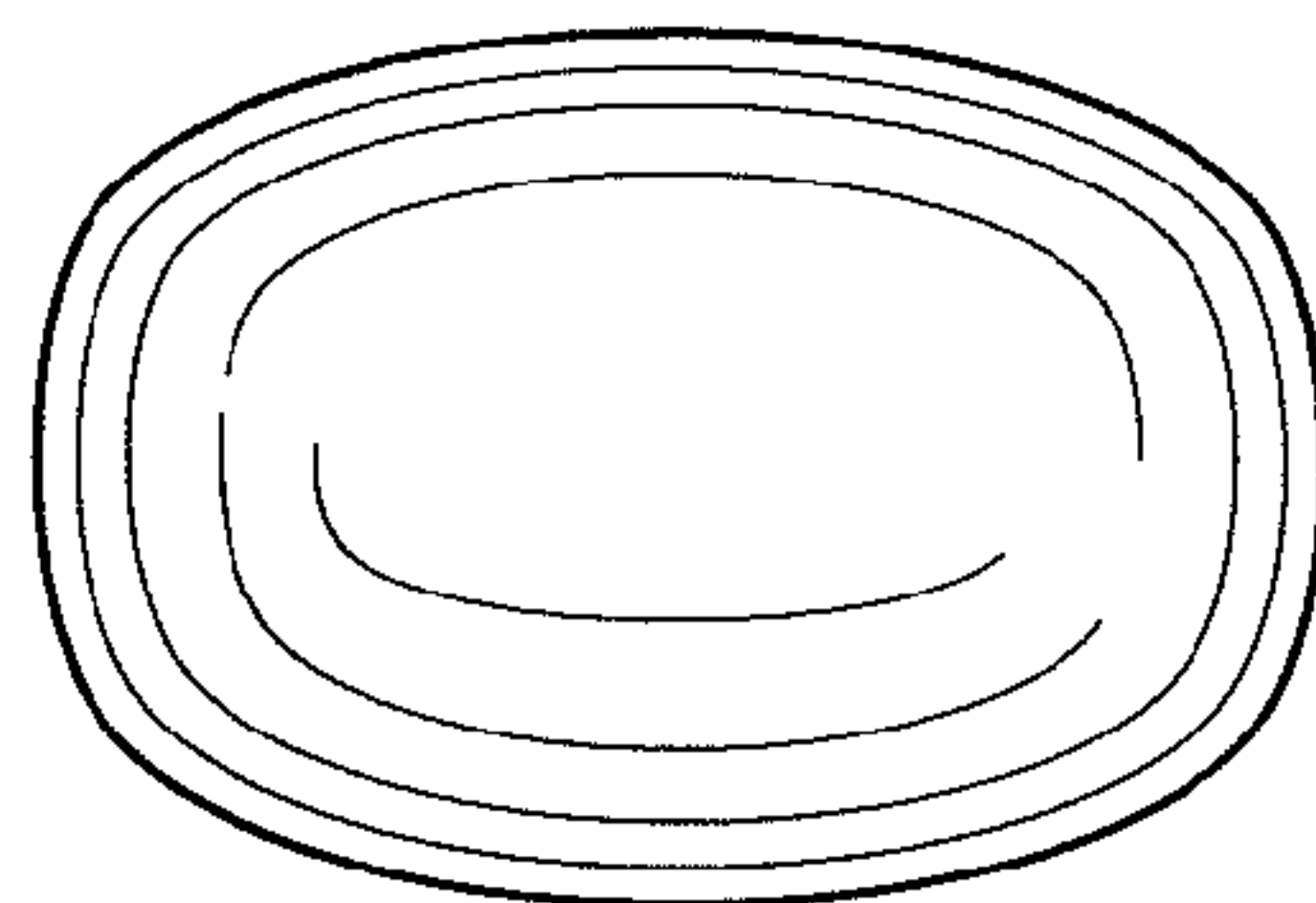

Fig. 16

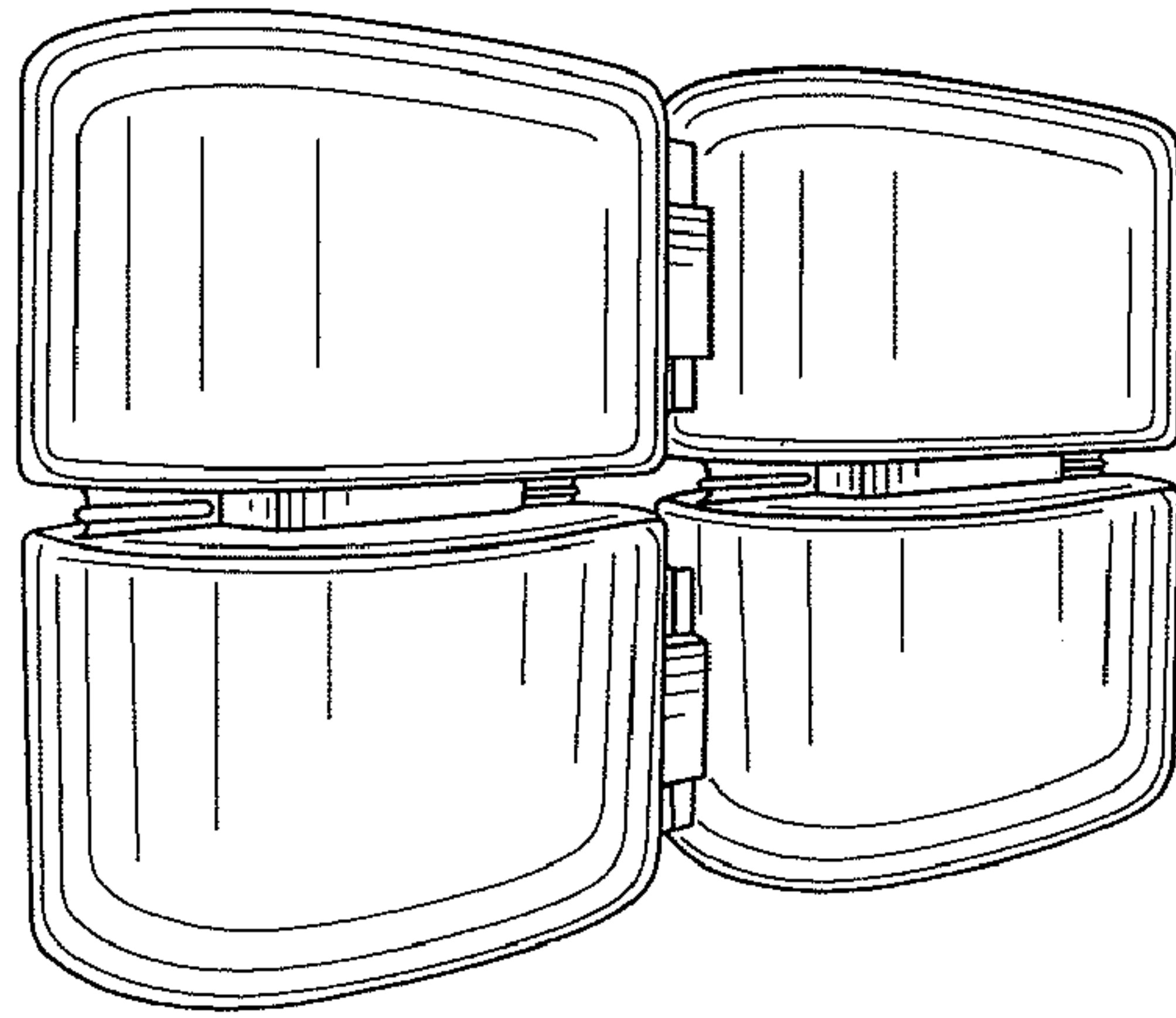

Fig. 17

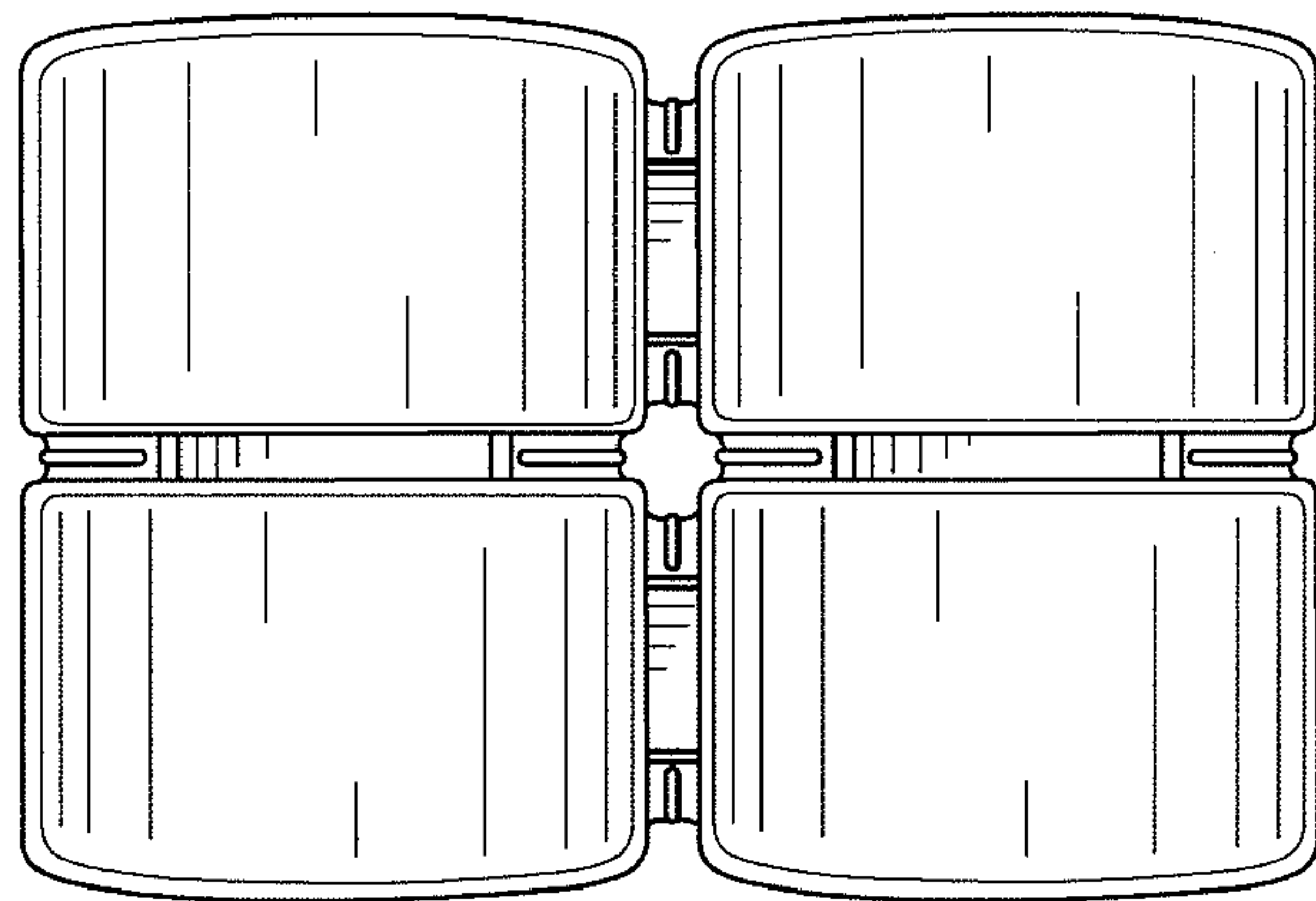

Fig. 18

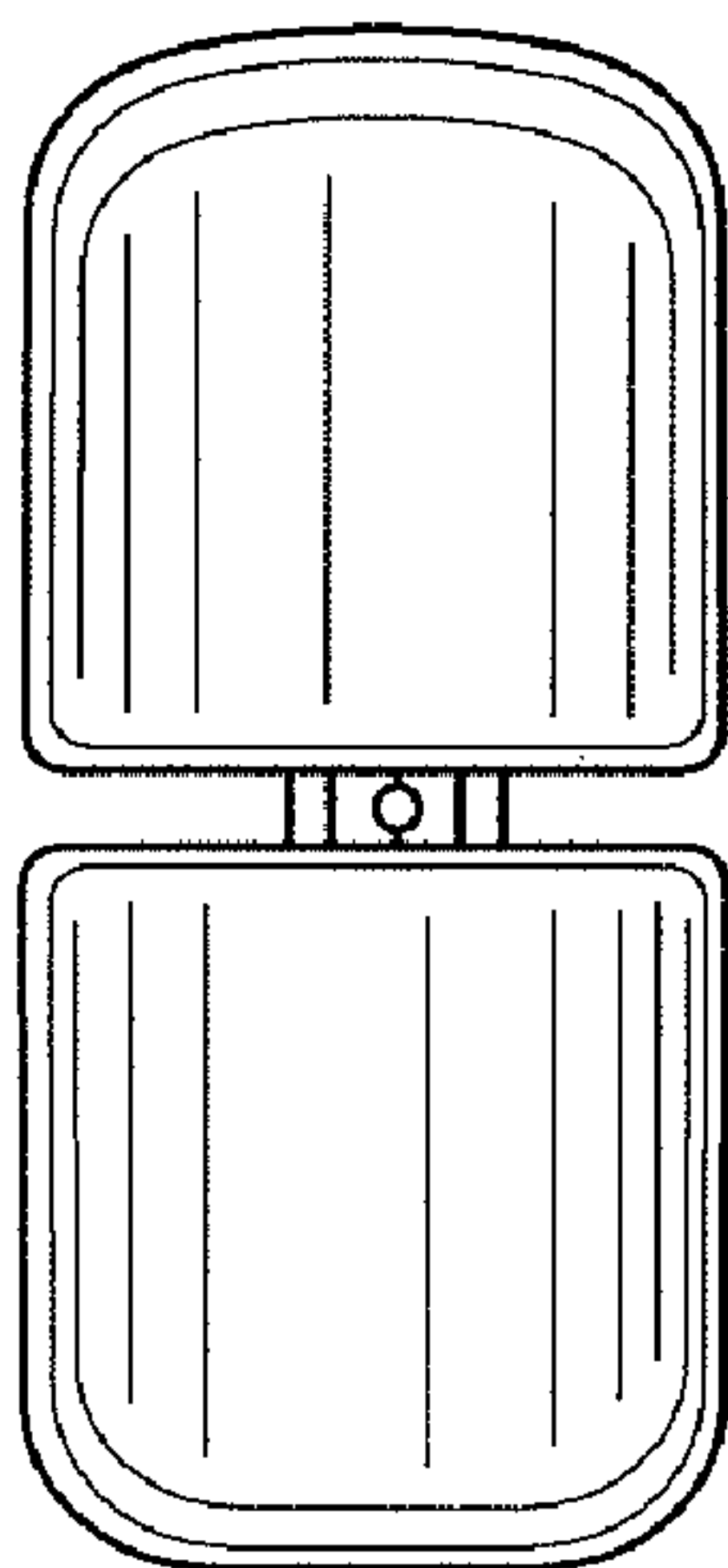

Fig. 19

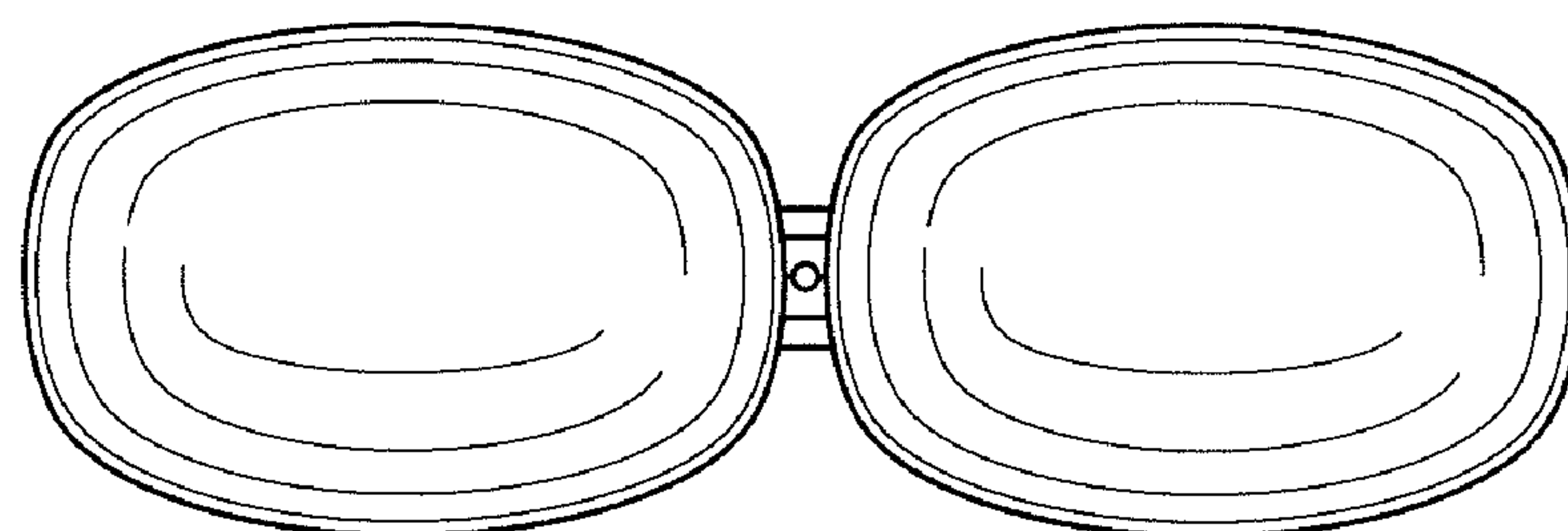

Fig. 20

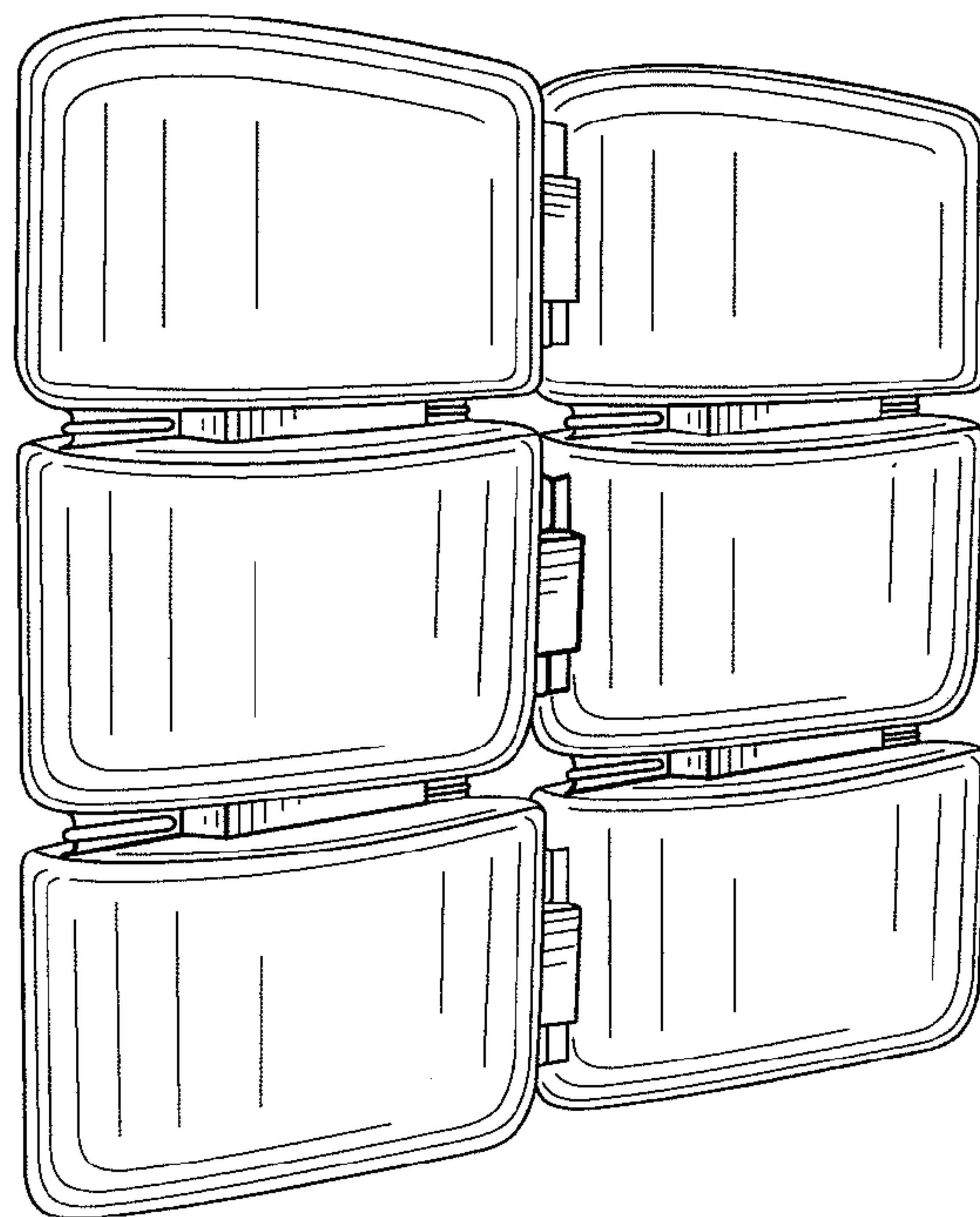

Fig. 21

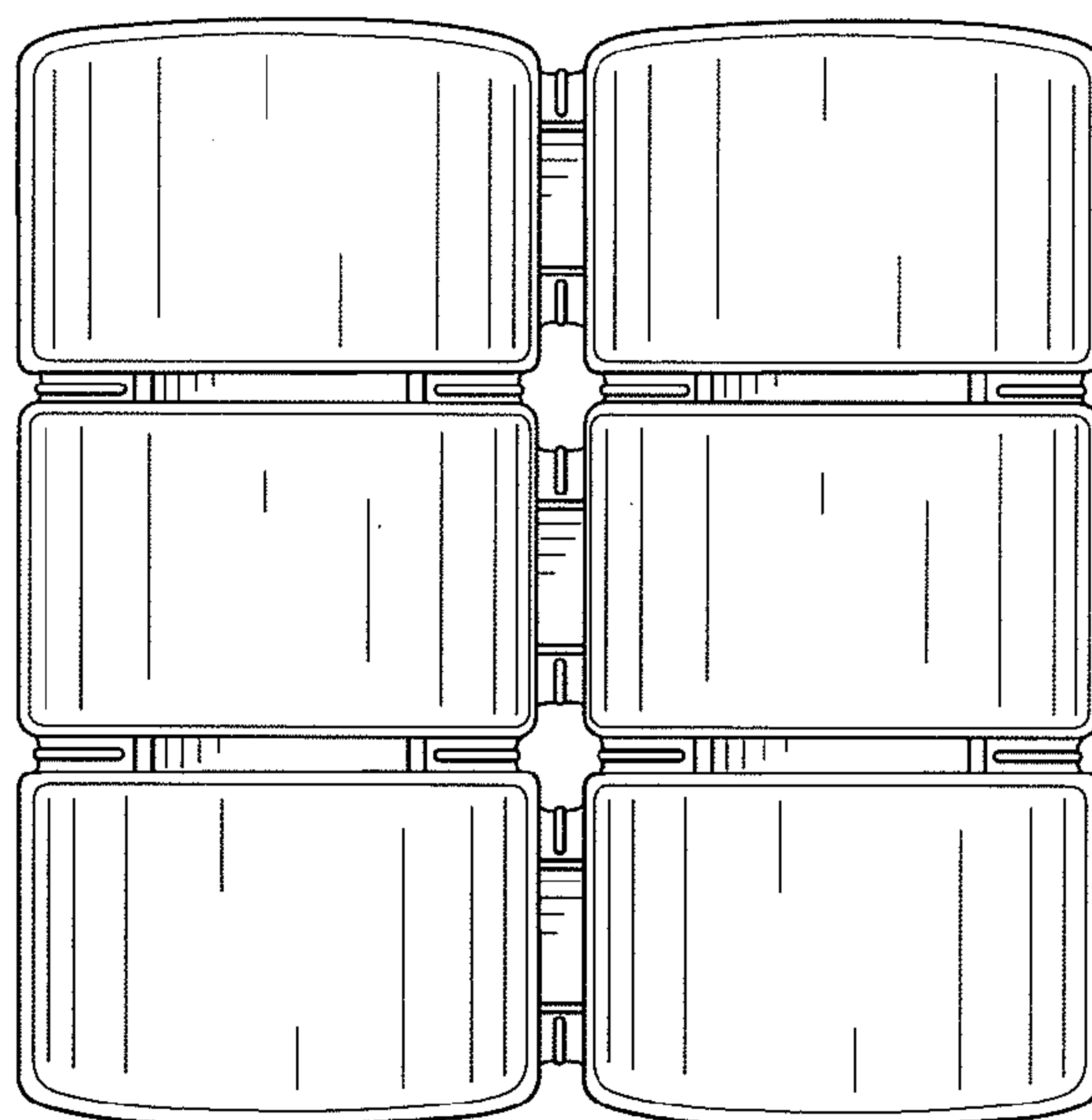

Fig. 22

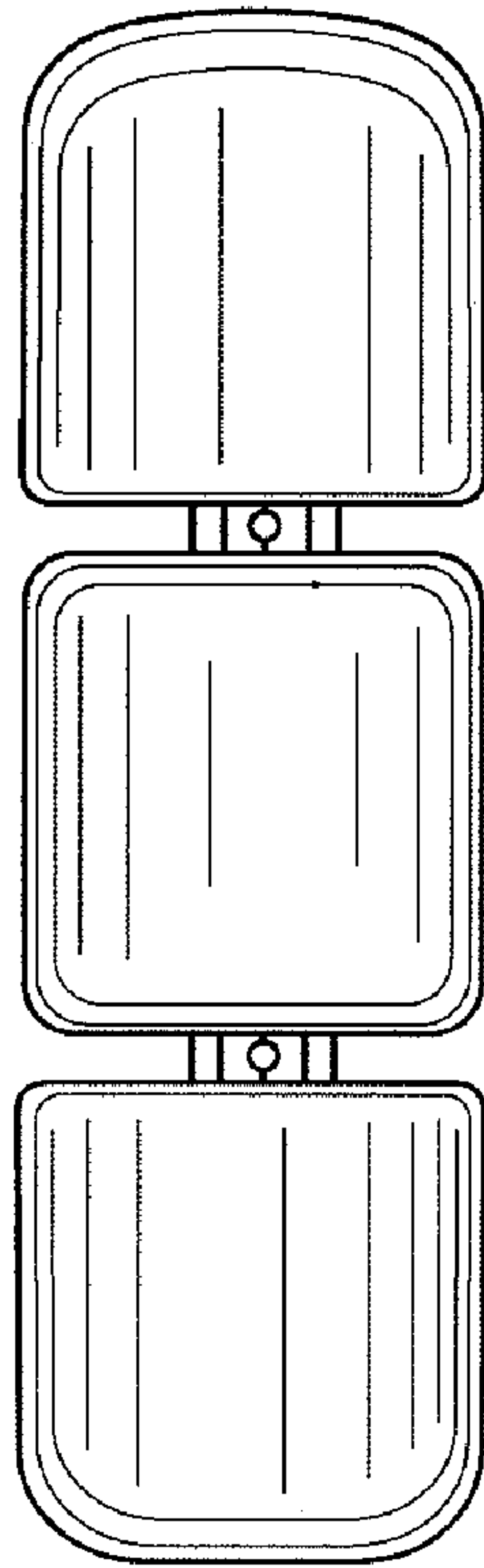

Fig. 23

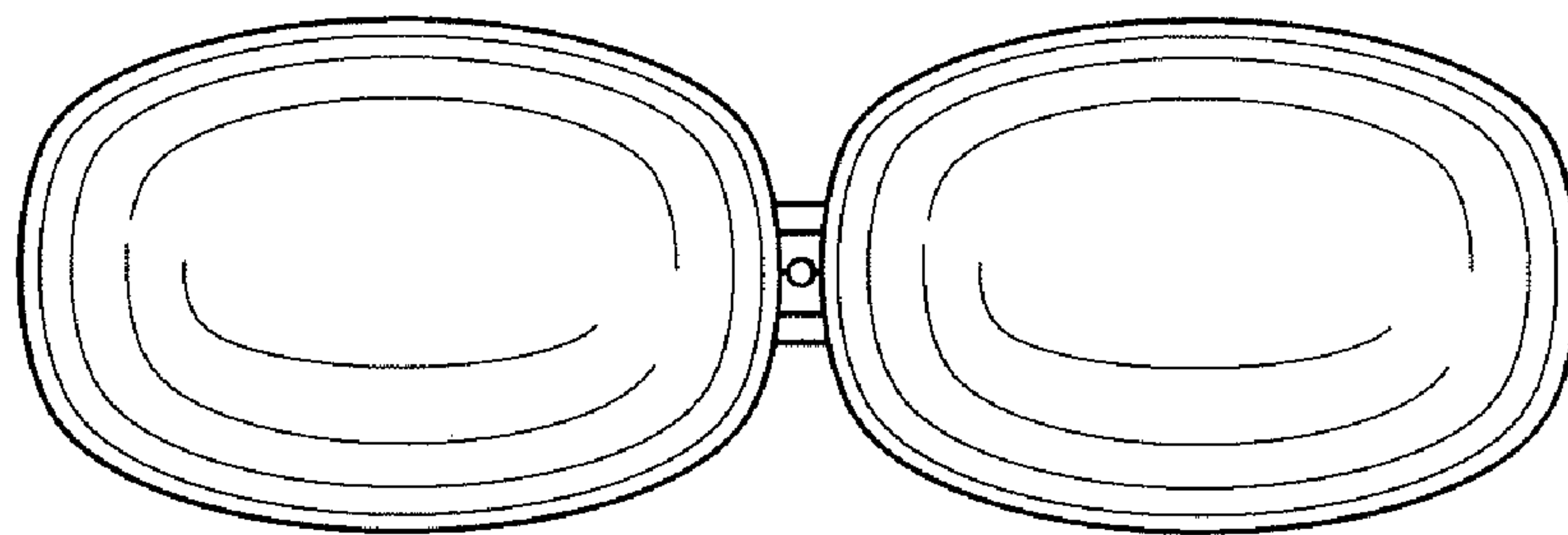

Fig. 24

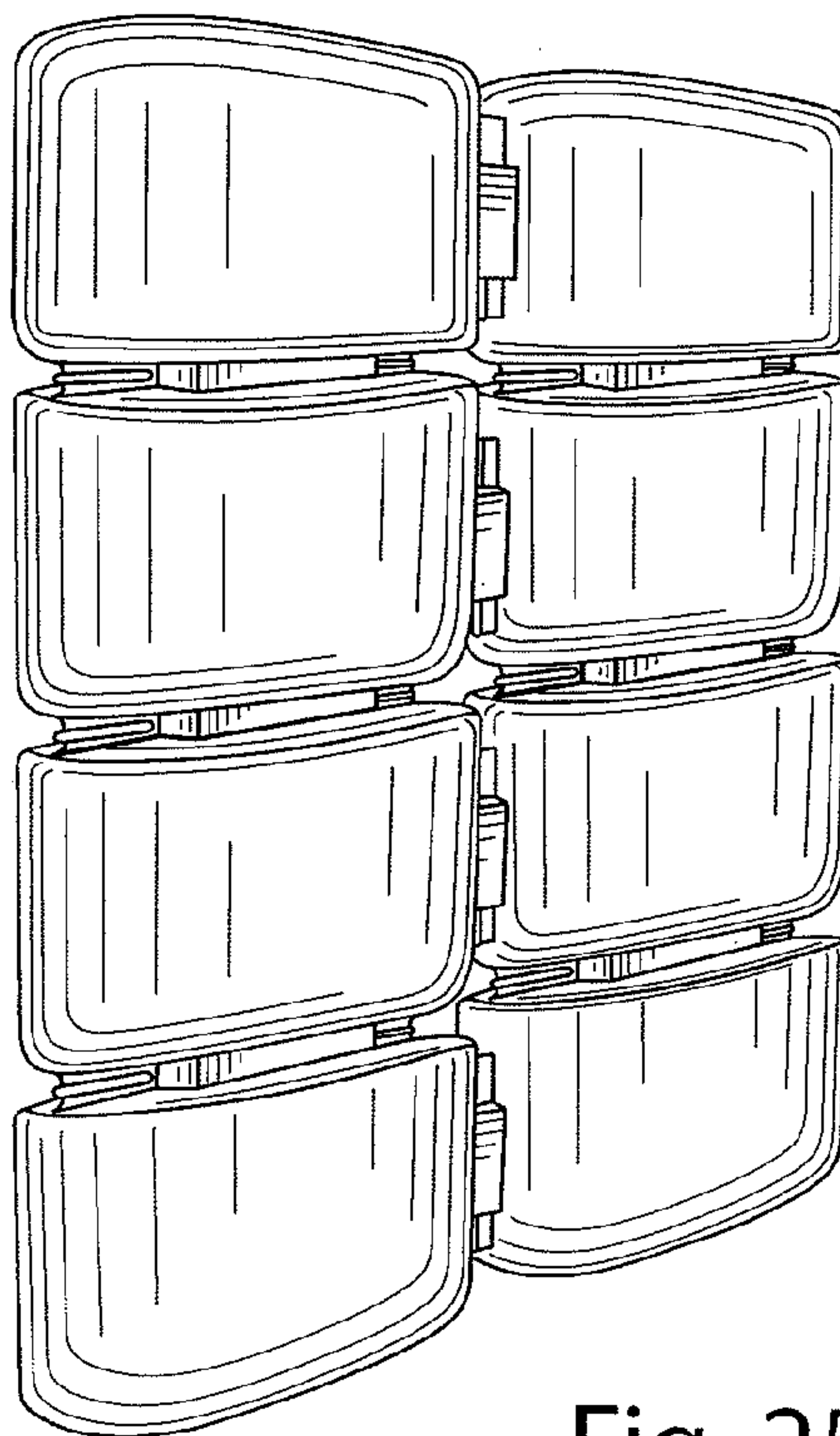

Fig. 25

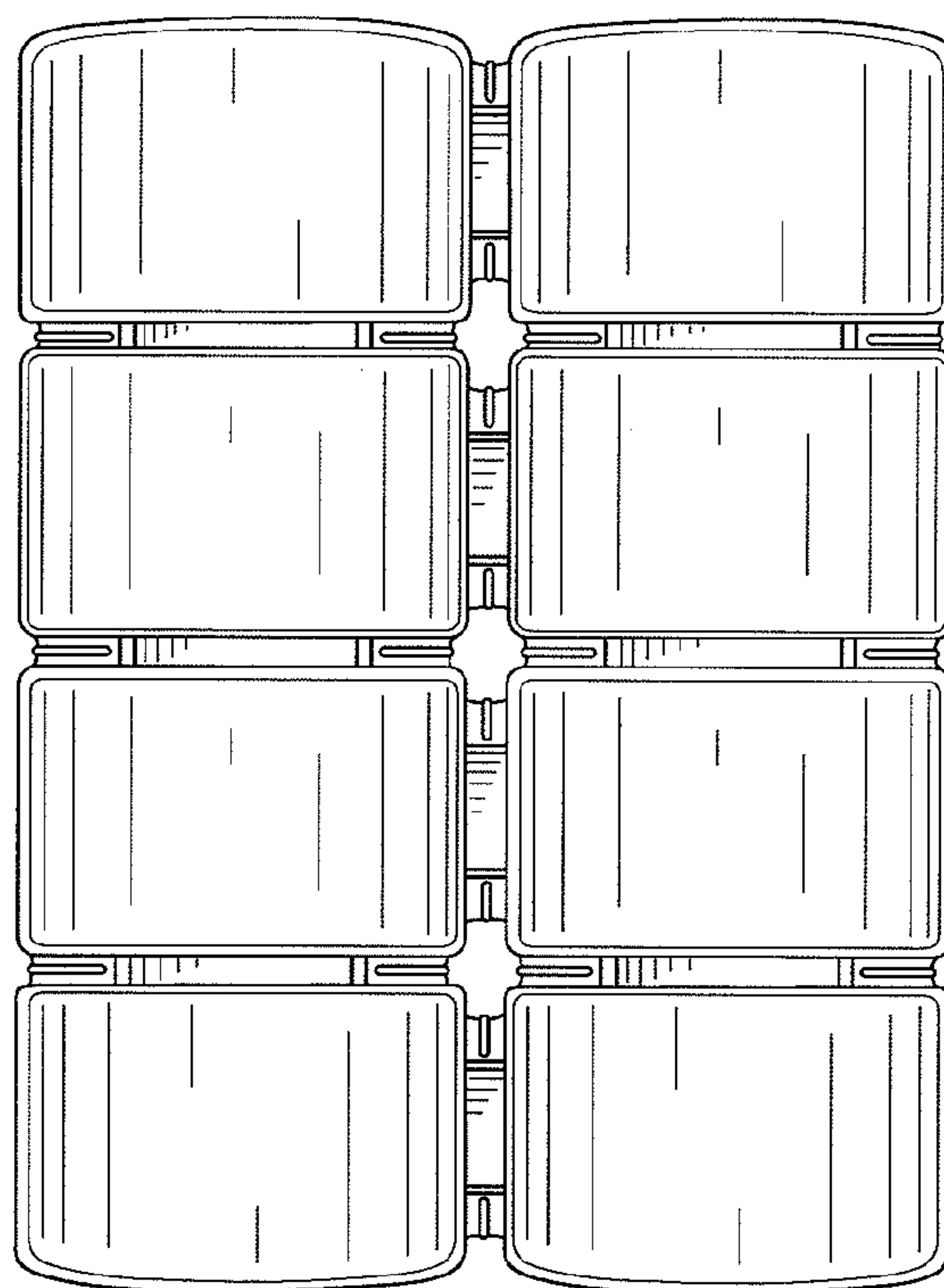

Fig. 26

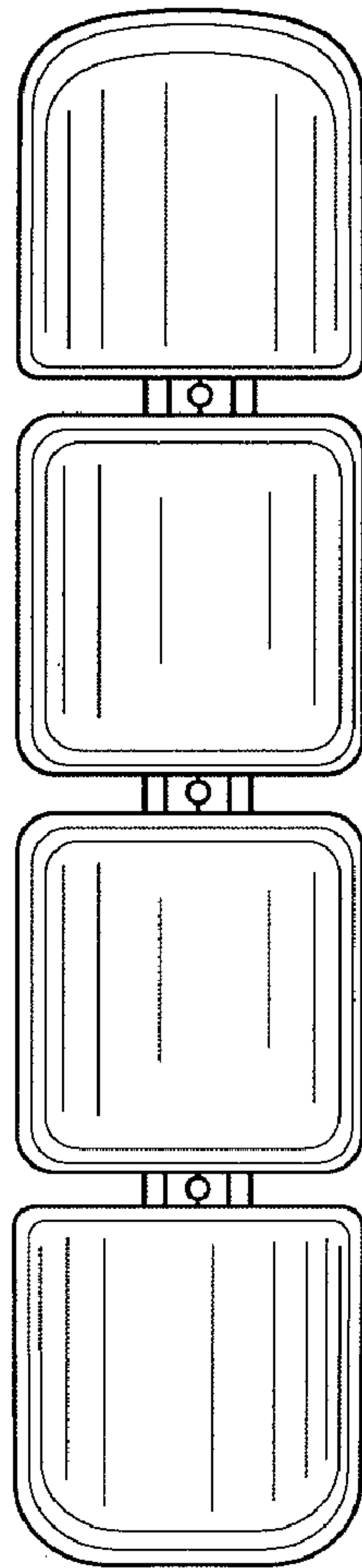

Fig. 27

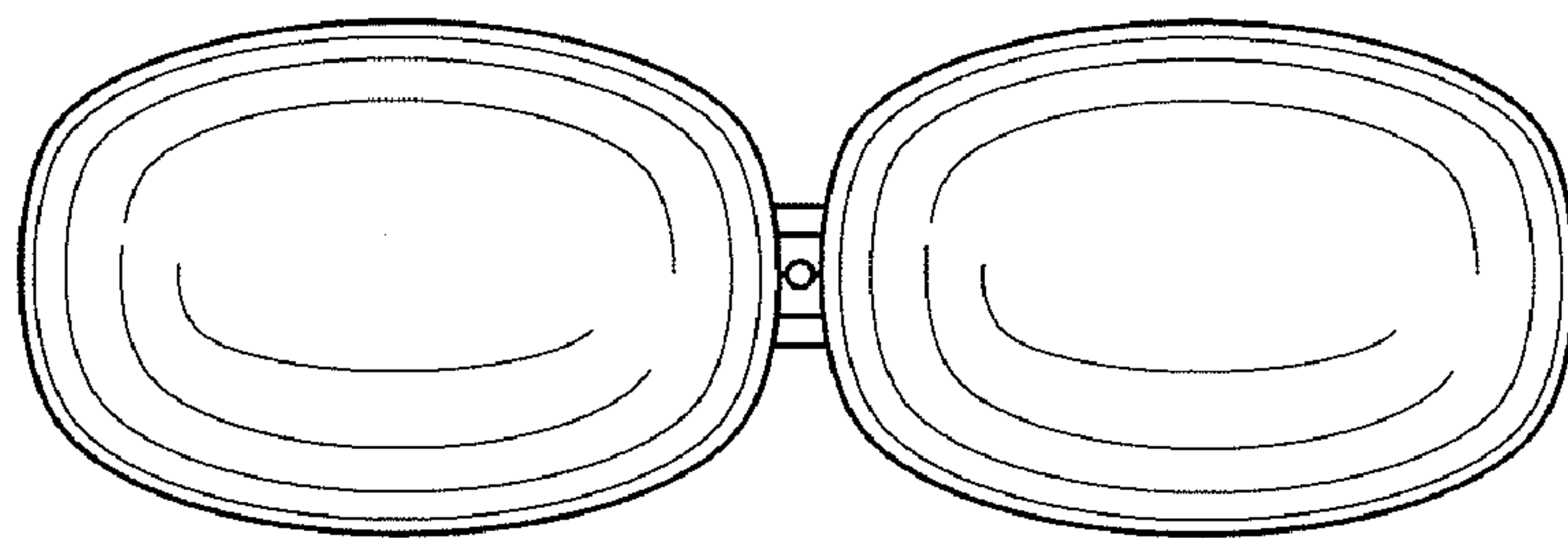

Fig. 28