



US00D627864S

(12) **United States Design Patent**
Eilmus et al.

(10) **Patent No.:** **US D627,864 S**

(45) **Date of Patent:** **** Nov. 23, 2010**

(54) **SINK**

(75) Inventors: **Niels J. Eilmus**, Sheboygan, WI (US);
Terrence K. Mahon, Whitefish Bay, WI (US); **Mary Reid**, Sheboygan, WI (US)

(73) Assignee: **Kohler Co.**, Kohler, WI (US)

(**) Term: **14 Years**

(21) Appl. No.: **29/336,324**

(22) Filed: **Apr. 30, 2009**

(51) **LOC (9) Cl.** **23-01**

(52) **U.S. Cl.** **D23/290**

(58) **Field of Classification Search** D23/290,
D23/308; 4/639

See application file for complete search history.

(56) **References Cited**

U.S. PATENT DOCUMENTS

D353,880 S * 12/1994 Hauser, II D23/290
D464,125 S * 10/2002 Bayer et al. D23/290
D610,659 S * 2/2010 Booth D23/290

OTHER PUBLICATIONS

Kohler Co. "Anthem Kitchen Sink". Model No. K-5840. Kohler Co. catalog.
Kohler Co. "Langlade Smart Divide Kitchen Sink". Model No. K-6626. Kohler Co. catalog.
Kohler Co. "Poise Double Equal Undercouner Kitchen Sink". Model No. K-3159. Kohler Co. online catalog. Copyright 2009 Kohler Co.

Kohler Co. "Entertainer Entertainment Sink". Model No. K-6558. Kohler Co. catalog.

* cited by examiner

Primary Examiner—Robert A Delehanty

(74) *Attorney, Agent, or Firm*—Quarles & Brady LLP

(57) **CLAIM**

The ornamental design for a sink, as shown and described.

DESCRIPTION

FIG. 1 is a right, top, front perspective view of a sink embodying our new design;

FIG. 2 is a top plan view thereof;

FIG. 3 is a front elevational view thereof;

FIG. 4 is a right side elevational view thereof, the left side elevational view thereof being a mirror image of the right side shown;

FIG. 5 is a rear elevational view thereof; and,

FIG. 6 is a bottom plan view thereof.

The broken line representations in the figures are for the purpose of illustration only, and form no part of the claimed design.

In a preferred embodiment, the nature of this product is as a plumbing fixture in the form of a sink which is primarily useful for washing various items.

1 Claim, 4 Drawing Sheets

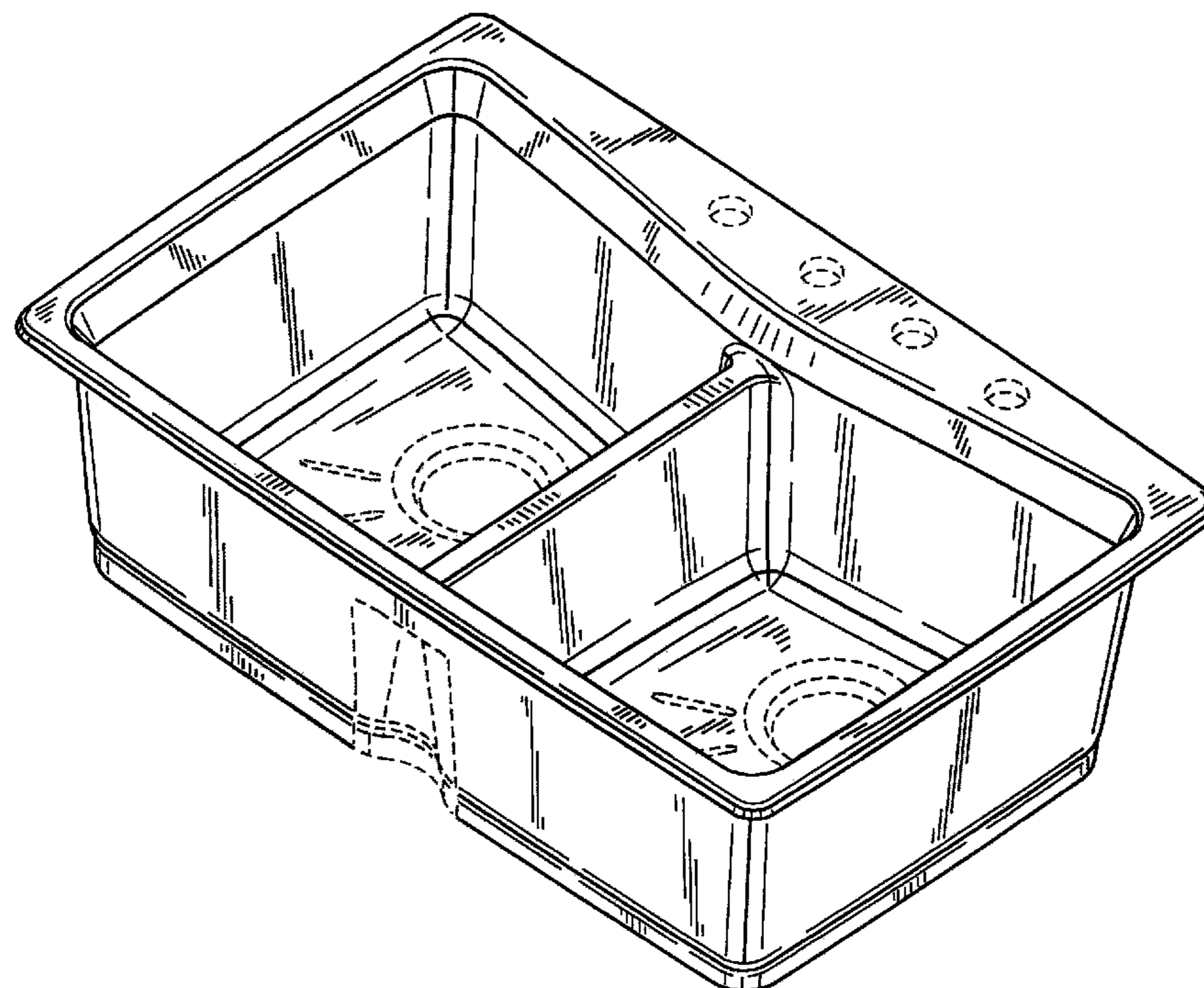

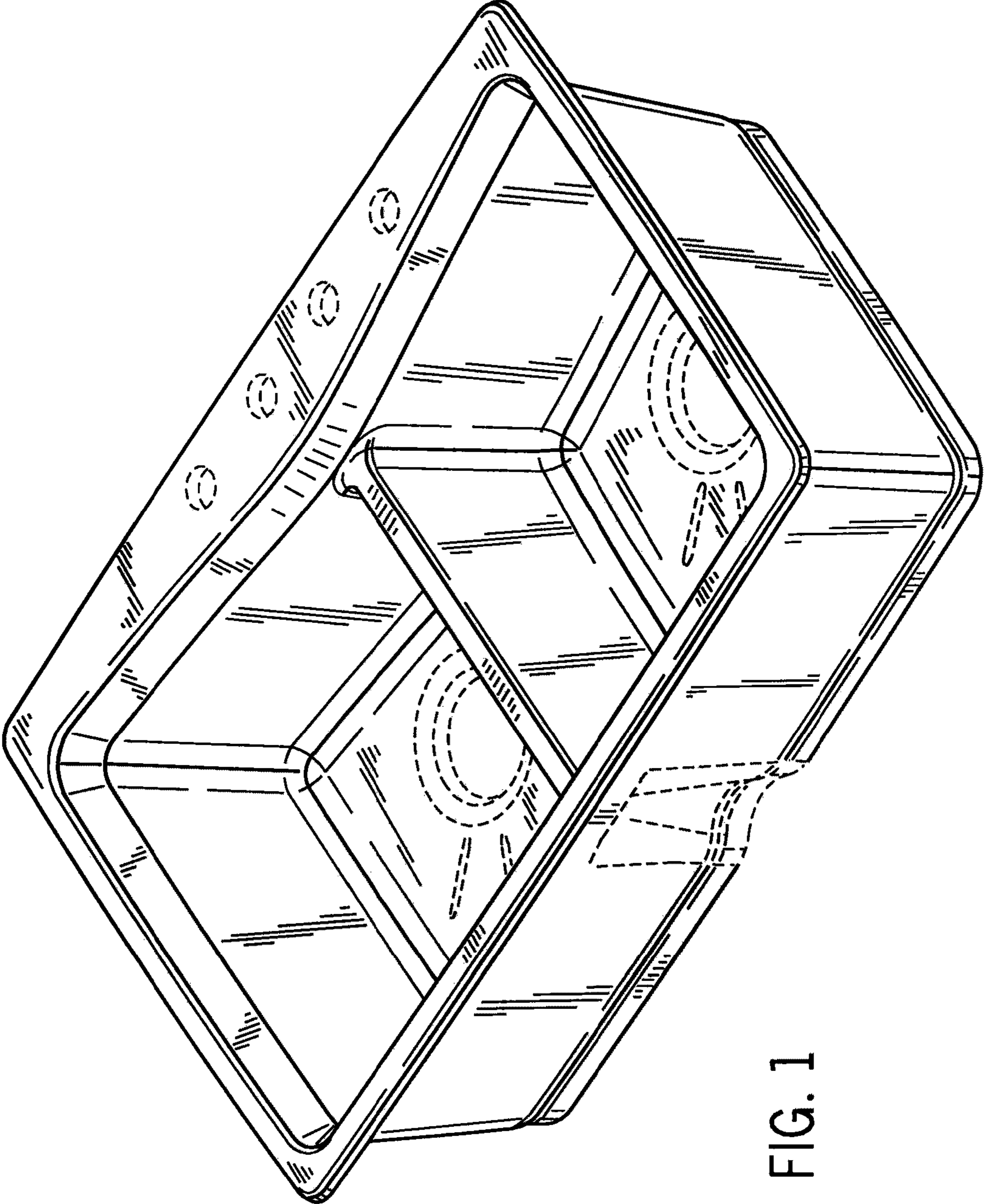

FIG. 1

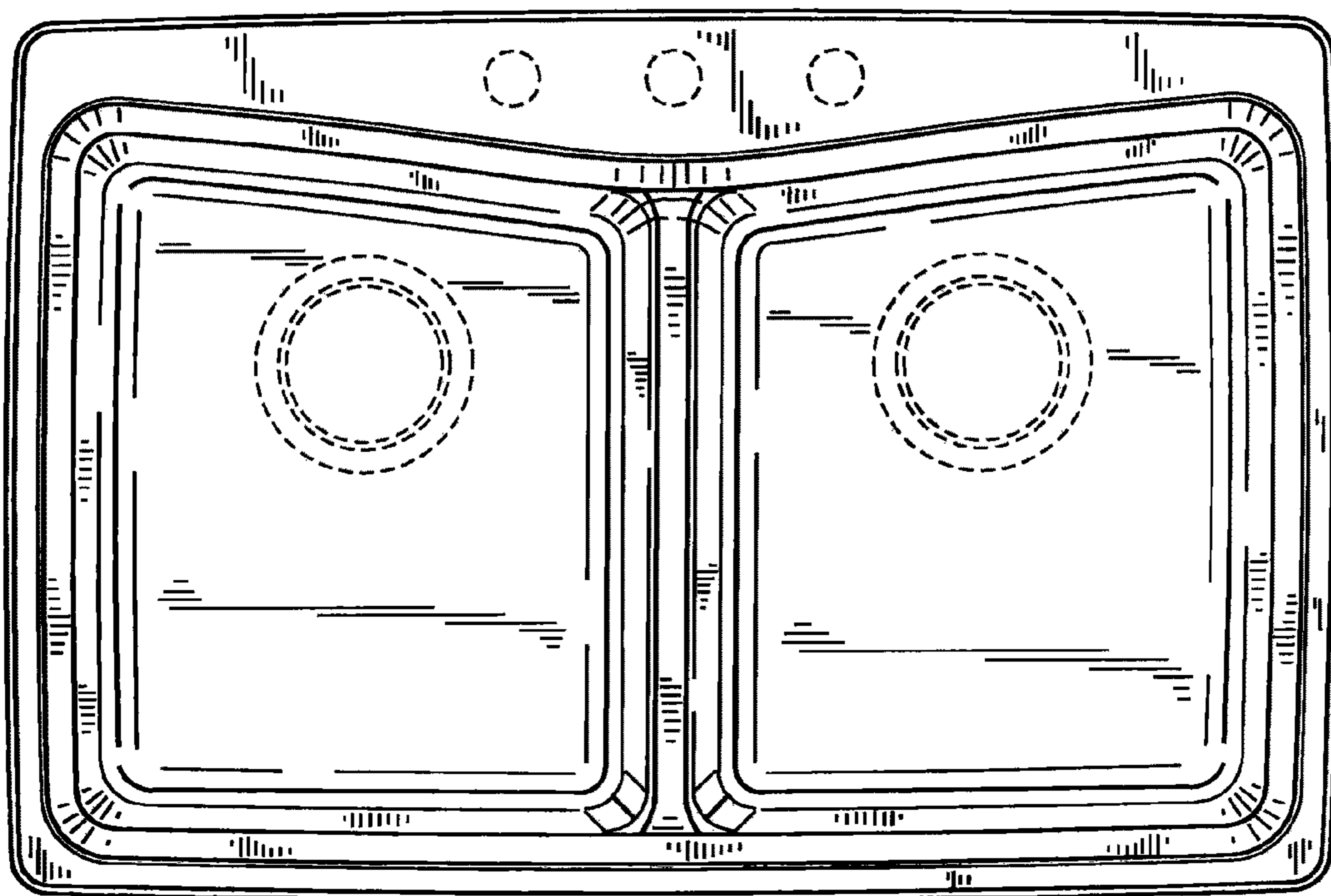

FIG. 2

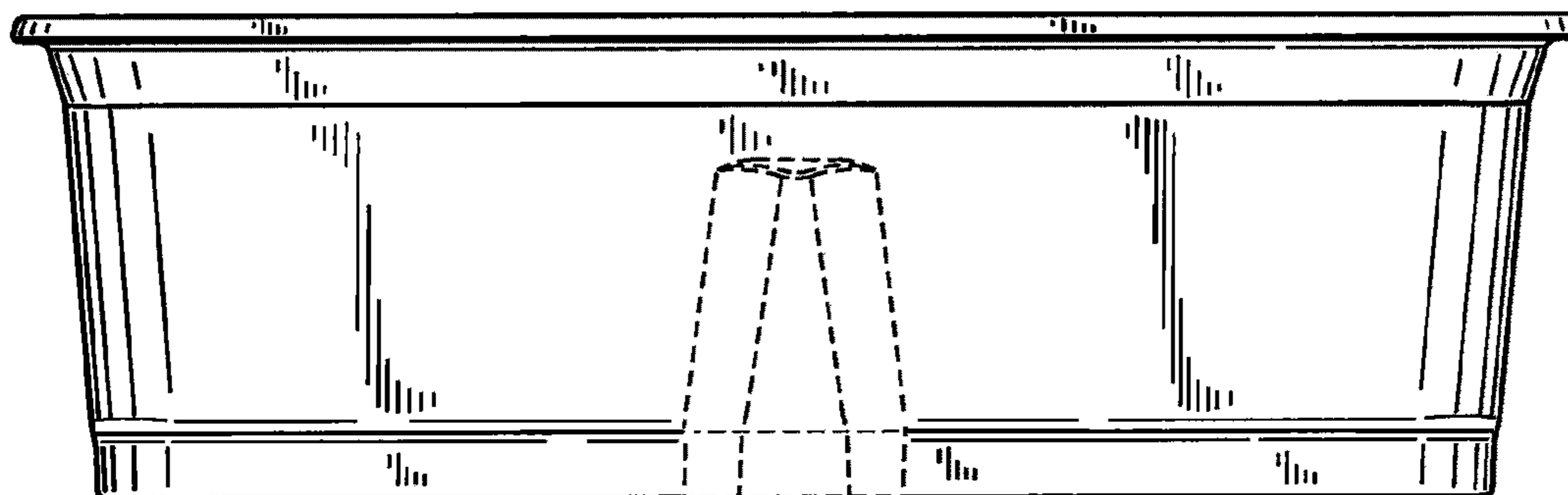

FIG. 3

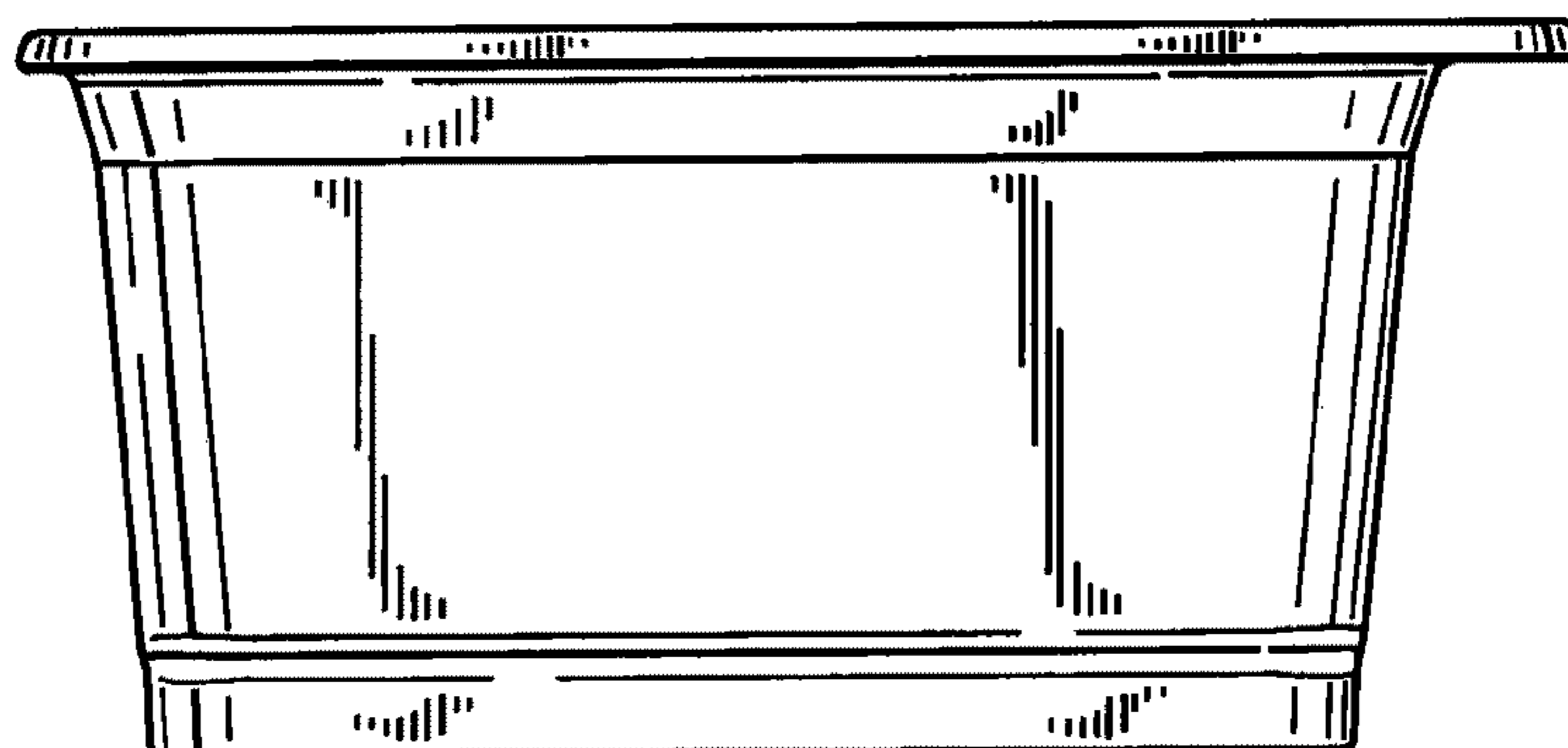

FIG. 4

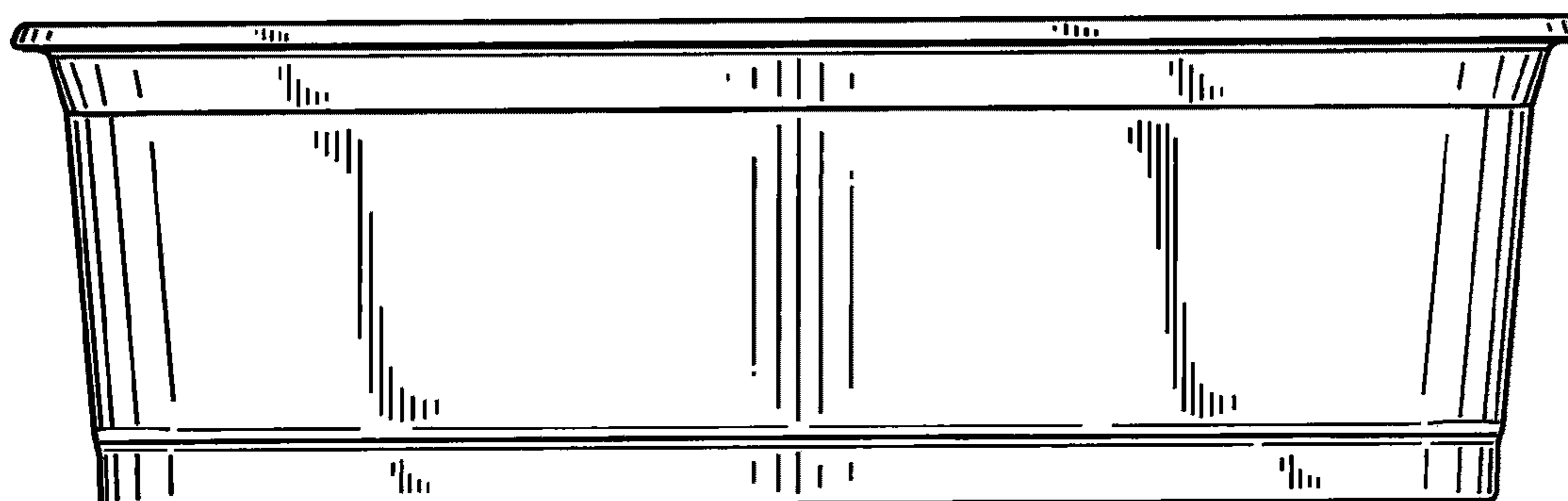

FIG. 5

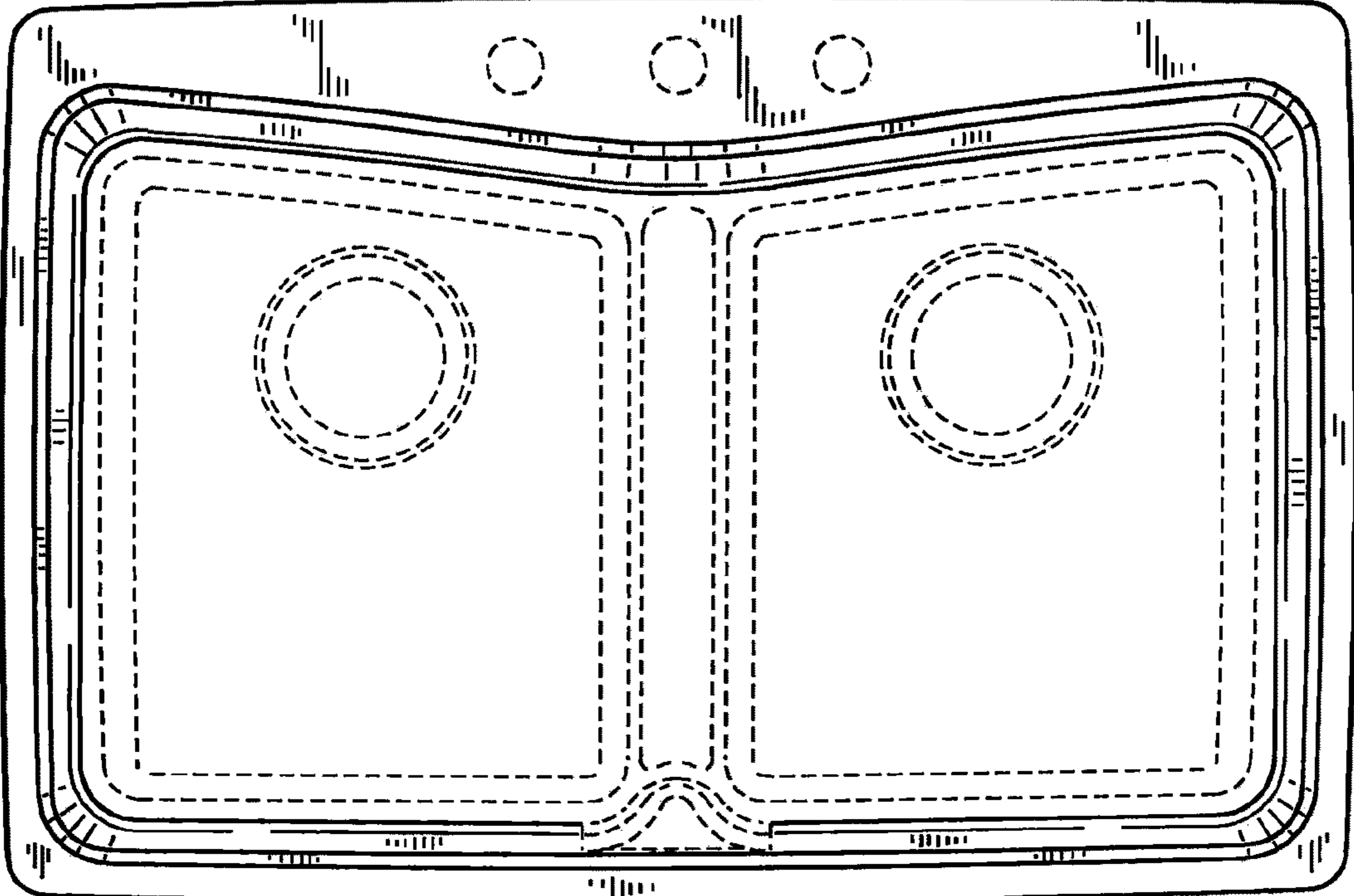

FIG. 6