



US00D627757S

(12) **United States Design Patent**  
**Weightman et al.**

(10) **Patent No.:** **US D627,757 S**  
(45) **Date of Patent:** **\*\* Nov. 23, 2010**

(54) **HANDSET**

(75) Inventors: **Christopher Weightman**, London (GB);  
**Casper Asmussen**, Malmö (SE)

(73) Assignee: **Nokia Corporation**, Espoo (FI)

(\*\*) Term: **14 Years**

(21) Appl. No.: **29/360,159**

(22) Filed: **Apr. 21, 2010**

(51) **LOC (9) Cl.** ..... **14-03**

(52) **U.S. Cl.** ..... **D14/138 AA**

(58) **Field of Classification Search** ..... D14/138 AA,  
D14/496, 341, 345, 346, 203.3, 203.4, 203.7,  
D14/138 AD, 138 R, 147, 148, 218, 137;  
455/575.1, 556.2, 575.3, 575.4; D21/517;  
379/433.01, 433.04; D13/168

See application file for complete search history.

(56) **References Cited**

**U.S. PATENT DOCUMENTS**

- D515,541 S \* 2/2006 Jensfelt ..... D14/138 AA
- D543,967 S \* 6/2007 Peng ..... D14/138 AA
- D545,800 S \* 7/2007 Ou et al. .... D14/138 AA
- D546,806 S \* 7/2007 Cho et al. .... D14/138 AA
- D548,219 S \* 8/2007 Hwang ..... D14/138 AA
- D560,630 S 1/2008 Mitchell et al.
- D561,153 S \* 2/2008 Hong et al. .... D14/138 AA
- D577,351 S \* 9/2008 Kim et al. .... D14/138 AA
- D579,910 S \* 11/2008 Fan et al. .... D14/138 AA
- D582,374 S \* 12/2008 Hu et al. .... D14/138 AA
- D588,087 S 3/2009 Stone
- D588,567 S 3/2009 Miles et al.
- D589,484 S 3/2009 Nenonen
- D595,707 S 7/2009 Miles et al.
- D597,540 S 8/2009 Schellen
- D599,337 S 9/2009 Miles et al.
- D601,531 S \* 10/2009 Lee et al. .... D14/138 AA
- D605,620 S \* 12/2009 Asmussen ..... D14/138 AA
- D606,039 S \* 12/2009 Henning ..... D14/138 AA
- D607,863 S \* 1/2010 Bang et al. .... D14/138 AA
- D608,355 S \* 1/2010 Fahlgren et al. .... D14/248

- D608,752 S \* 1/2010 He ..... D14/138 AA
- D609,205 S \* 2/2010 Li et al. .... D14/138 AA
- D609,207 S \* 2/2010 Leung et al. .... D14/138 AA
- D610,118 S \* 2/2010 Boucquey et al. .... D14/138 AA
- D610,564 S \* 2/2010 Schellen ..... D14/138 AA
- D617,292 S \* 6/2010 Chen et al. .... D14/138 AA
- D617,299 S \* 6/2010 Tzeng et al. .... D14/138 AA
- D617,300 S \* 6/2010 Tzeng et al. .... D14/138 AA
- D617,752 S \* 6/2010 Montin ..... D14/138 AA
- 2007/0287302 A1 \* 12/2007 Lindberg et al. .... 439/38

**OTHER PUBLICATIONS**

Nokia C3-01 Touch and Type telephone, announced Sep. 2010, [online]. [site visited Sep. 22, 2010]. Available from Internet, <URL: <http://www.gsmarena.com>>.\*

(Continued)

*Primary Examiner*—Jeffrey D Asch  
(74) *Attorney, Agent, or Firm*—Banner & Witcoff, Ltd.

(57) **CLAIM**

The ornamental design for a handset, as shown and described.

**DESCRIPTION**

FIG. 1 is a perspective front view of a handset showing our new design;

FIG. 2 is a front view thereof;

FIG. 3 is a rear view thereof;

FIG. 4 is a right side view thereof;

FIG. 5 is a left side view thereof;

FIG. 6 is a top view thereof; and,

FIG. 7 is a bottom view thereof.

The broken line showing of the environment of the handset in FIGS. 1-7 is for illustrative purposes only and forms no part of the claimed design. The unshaded regions within the boundaries formed by the broken lines are not a part of the claimed design.

**1 Claim, 4 Drawing Sheets**

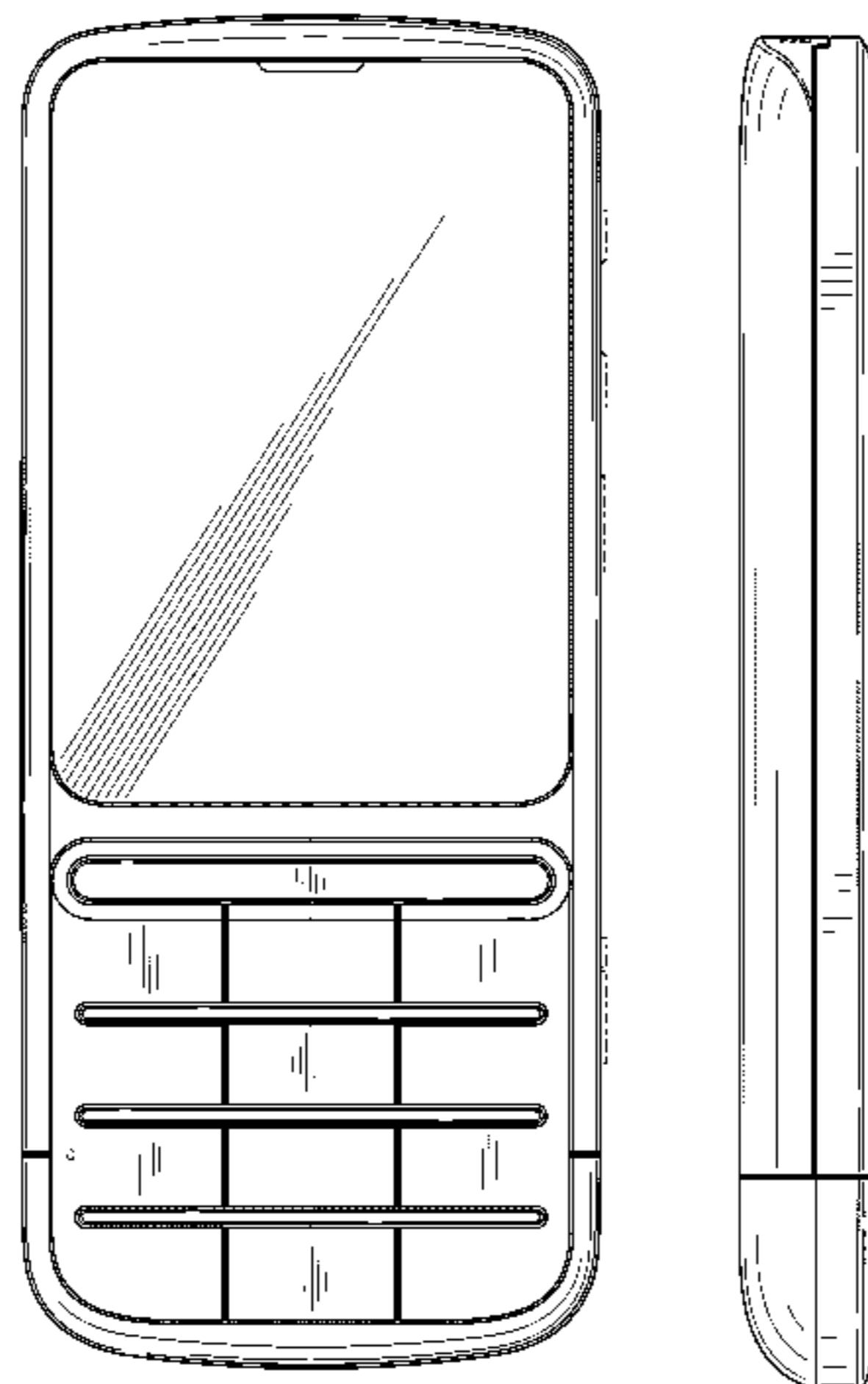

OTHER PUBLICATIONS

Nokia 6700 classic telephone, announced Jan. 2009, [online], [site visited Sep. 22, 2010]. Available from Internet, <URL: <http://www.gsmarena.com>>.\*

Nokia 2700 classic telephone, announced Jan. 2009, [online], [site visited Sep. 22, 2010]. Available from Internet, <URL: <http://www.gsmarena.com>>.\*

Nokia C5 TD-SCMA telephone, announced Apr. 2010, [online], [site visited Sep. 22, 2010]. Available from Internet, <URL: <http://www.gsmarena.com>>.\*

Nokia 3109 Classic, Nokia Corporation, 1 color sheet of photographs, disclosed on or about May 2007.

Nokia 5030, Nokia Corporation, 1 color sheet of photographs, disclosed on or about Mar. 2009.

Nokia 5130 XpressMusic, Nokia Corporation, 1 color sheet of photographs, disclosed on or about Feb. 2009.

Nokia 6080, Nokia Corporation, 1 color sheet of photographs, disclosed on or about Jun. 2006.

Nokia 7210 Supernova, Nokia Corporation, 1 color sheet of photographs, disclosed on about Jun. 2008.

Nokia 5610 XpressMusic, Nokia Corporation, 1 color sheet of photographs, disclosed on or about Aug. 2, 2007.

\* cited by examiner

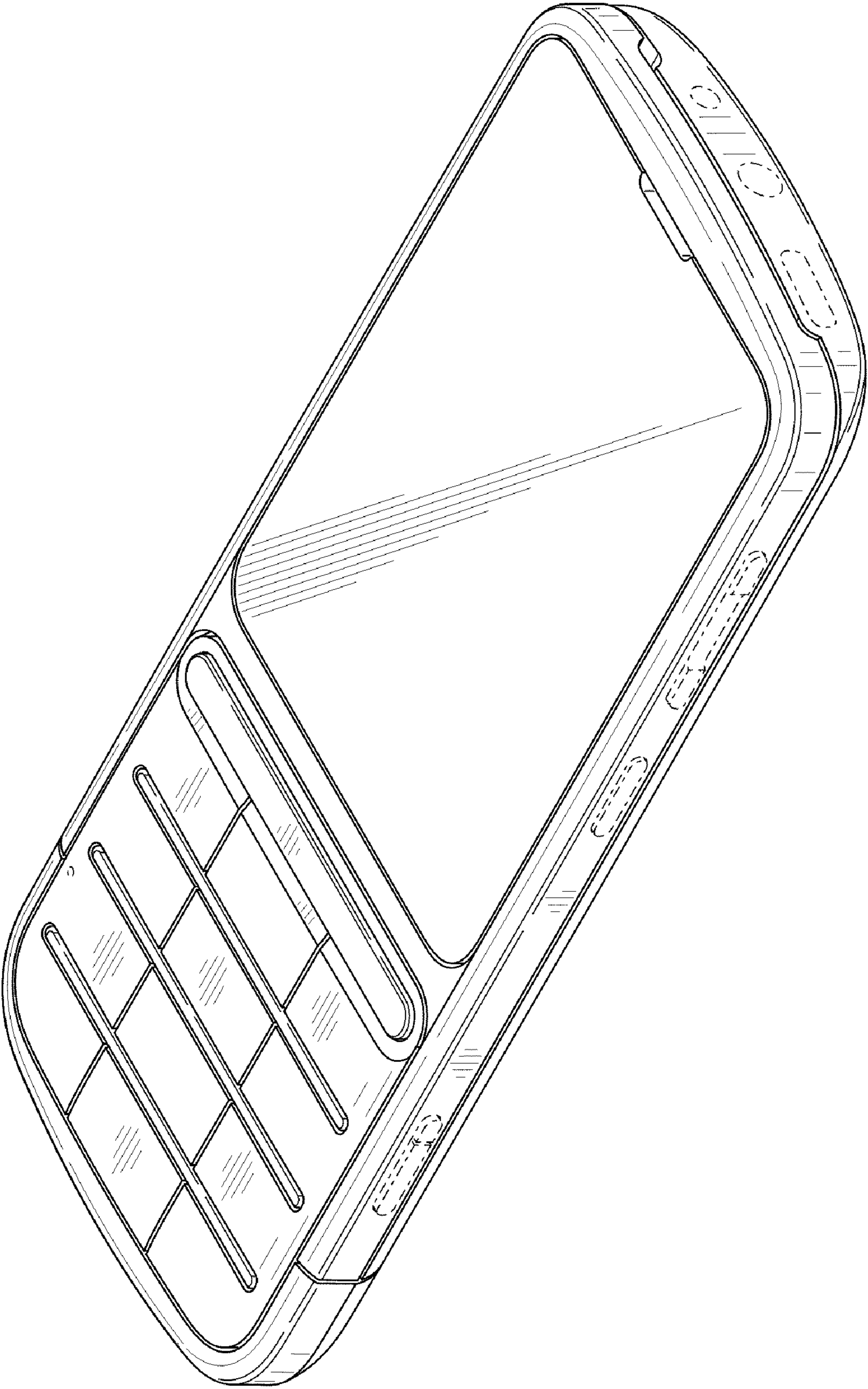

FIG. 1

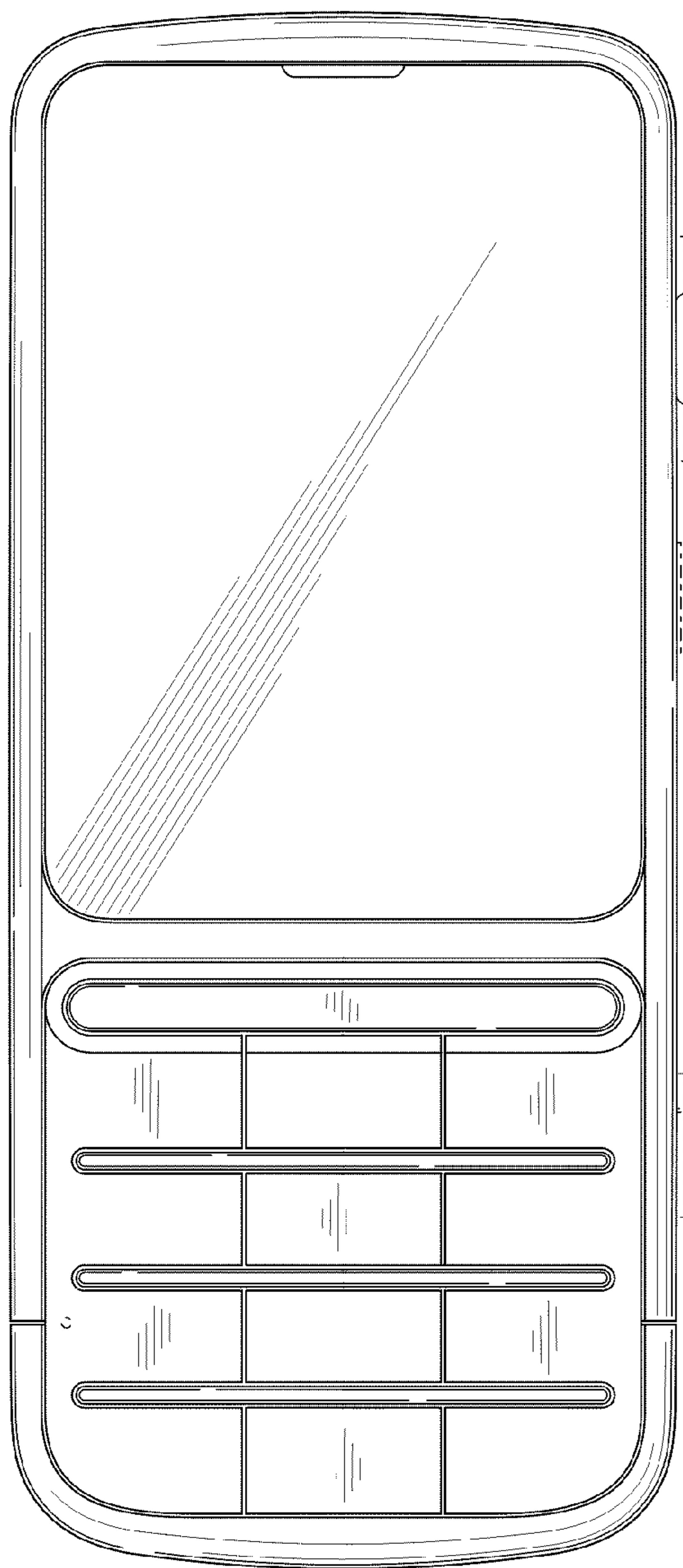

FIG. 2

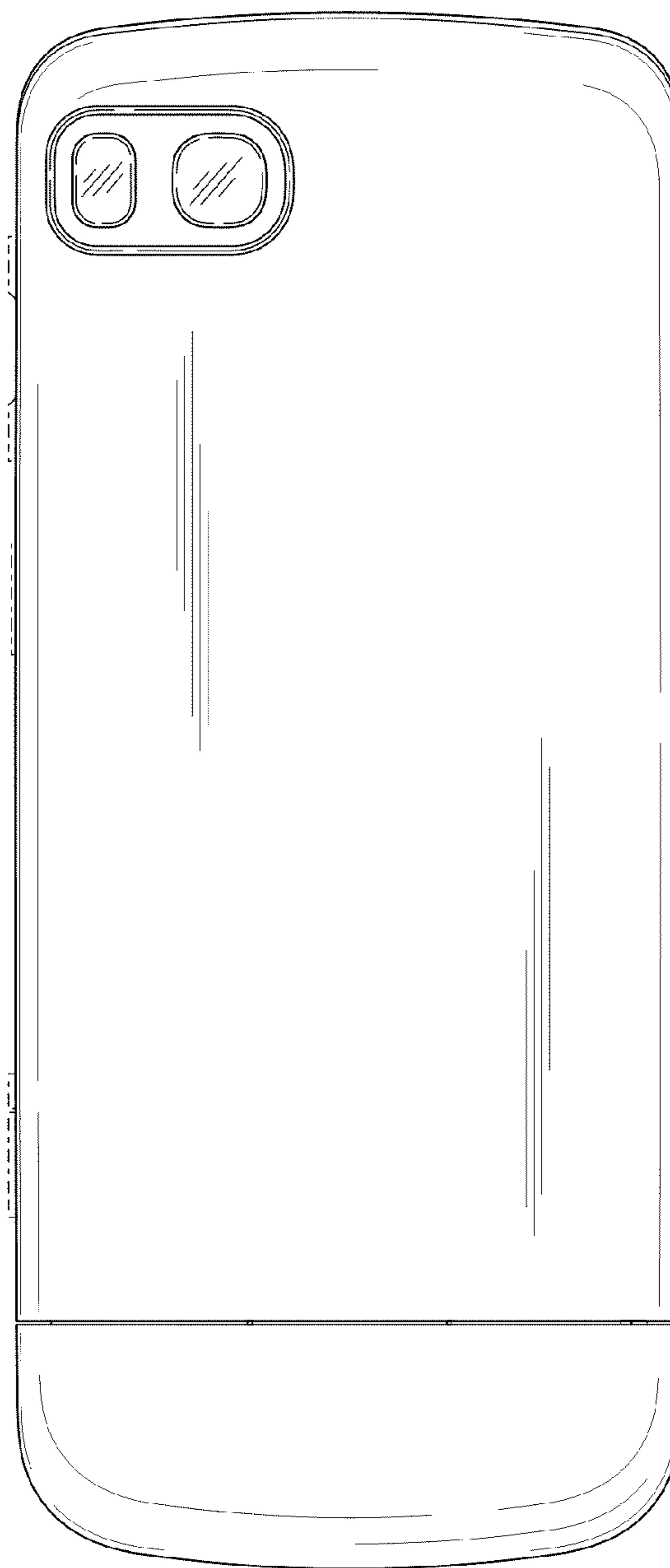

FIG. 3

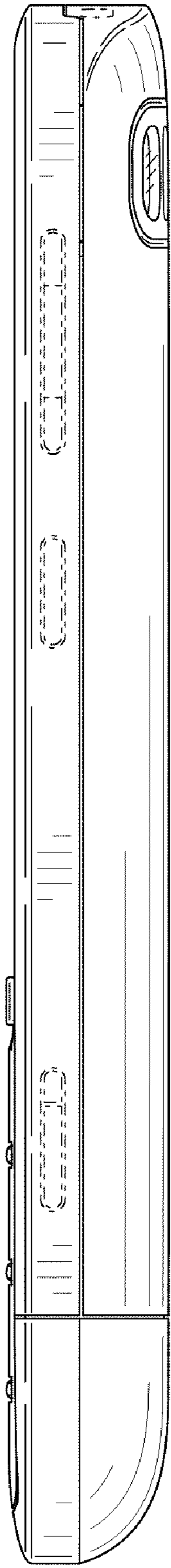

FIG. 4

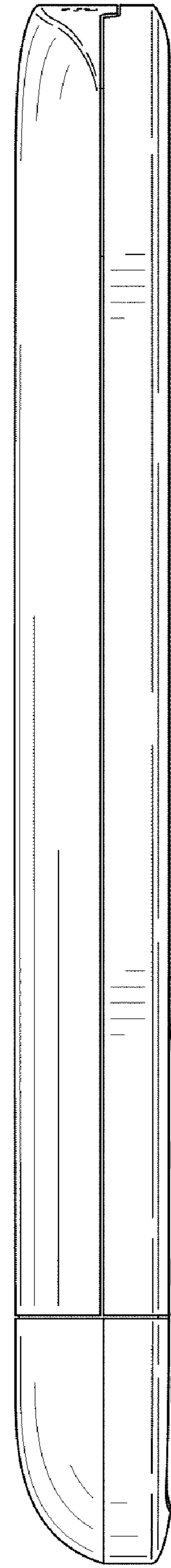
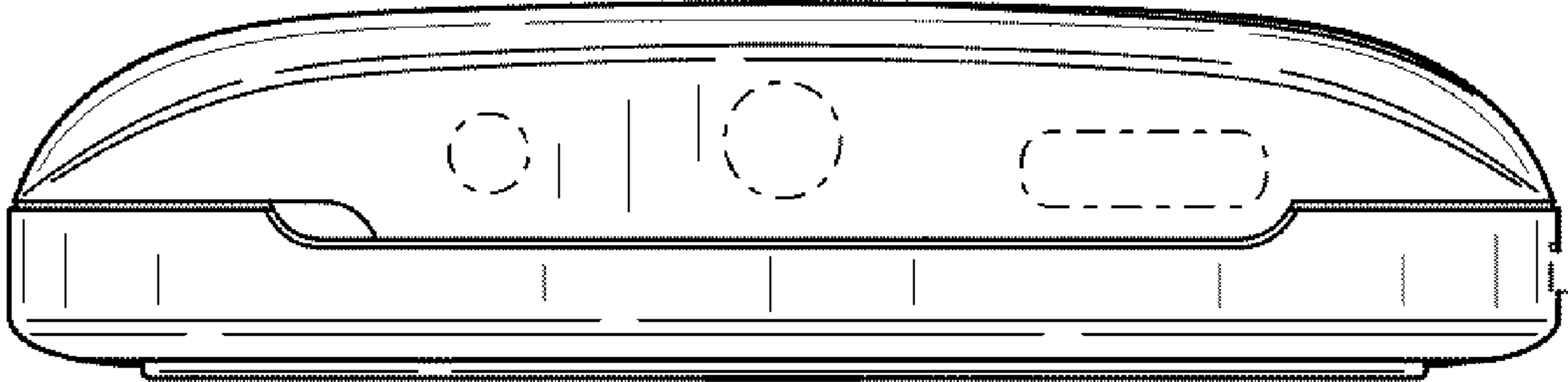
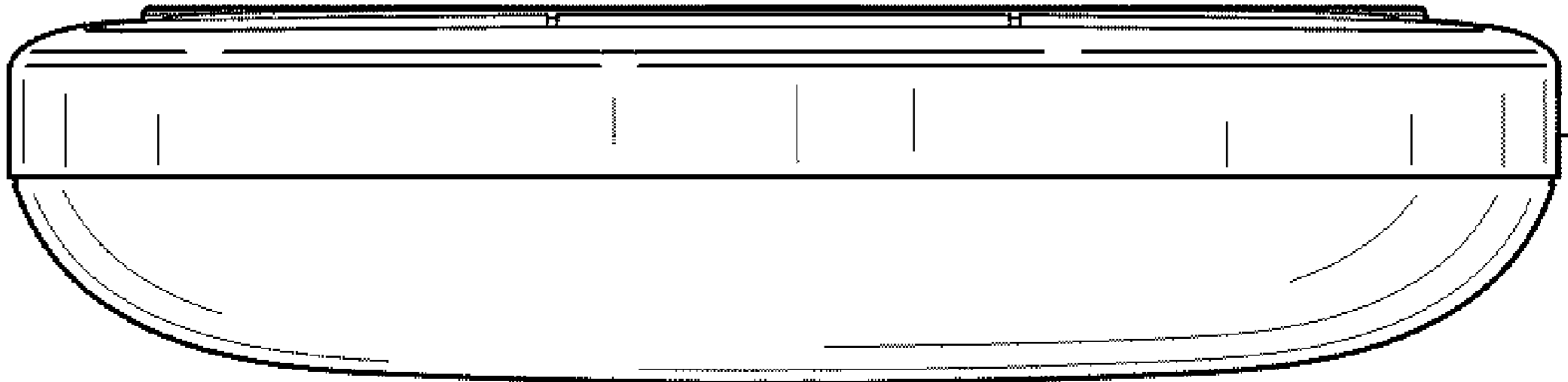

FIG. 5



**FIG. 6**



**FIG. 7**