



US00D627744S

(12) **United States Design Patent**  
**Yano**

(10) **Patent No.:** **US D627,744 S**  
(45) **Date of Patent:** **\*\* Nov. 23, 2010**

(54) **REMOTE CONTROLLER**

(75) Inventor: **Ken Yano**, Tokyo (JP)

(73) Assignee: **Sony Computer Entertainment Inc.**,  
Tokyo (JP)

(\*\*) Term: **14 Years**

(21) Appl. No.: **29/347,255**

(22) Filed: **Nov. 13, 2009**

(30) **Foreign Application Priority Data**

Oct. 28, 2009 (JP) ..... D2009-025261

(51) **LOC (9) Cl.** ..... **14-03**

(52) **U.S. Cl.** ..... **D13/168**

(58) **Field of Classification Search** ..... D13/168;  
D9/503, 519, 549; D14/218, 247, 400, 401;  
340/825.22, 825.24, 825.25, 825.31, 825.36,  
340/825.69, 825.72; 341/176; 455/352;  
345/156; D21/333; D24/197; D99/99; 273/148 B  
See application file for complete search history.

(56) **References Cited**

**U.S. PATENT DOCUMENTS**

D136,501 S \* 10/1943 Habif ..... D9/503  
D307,545 S \* 5/1990 Hibbert ..... D9/503  
D370,915 S \* 6/1996 Kava et al. .... D14/218  
D389,151 S 1/1998 Shintani  
D410,468 S 6/1999 Kazama

6,120,379 A \* 9/2000 Tanaka et al. .... 463/44  
D487,450 S 3/2004 Hakoda  
D504,886 S 5/2005 Yasutomi  
D513,233 S \* 12/2005 Stauffer ..... D13/168  
D531,992 S \* 11/2006 Hoehn et al. .... D14/218  
D572,206 S \* 7/2008 Ikeda et al. .... D13/168  
D594,066 S \* 6/2009 Oikawa et al. .... D21/333  
7,637,382 B2 \* 12/2009 Kraus et al. .... 215/11.1

\* cited by examiner

*Primary Examiner*—Selina Sikder

(74) *Attorney, Agent, or Firm*—Rader, Fishman & Grauer  
PLLC

(57) **CLAIM**

The ornamental design for a remote controller, as shown.

**DESCRIPTION**

FIG. 1 is a front, top, left perspective view of a remote controller showing my new design;

FIG. 2 is a rear, bottom, left perspective view thereof;

FIG. 3 is a front elevational view thereof;

FIG. 4 is a rear elevational view thereof;

FIG. 5 is a left side elevational view thereof;

FIG. 6 is a right side elevational view thereof;

FIG. 7 is a top plan view thereof; and,

FIG. 8 is a bottom plan view thereof.

**1 Claim, 7 Drawing Sheets**

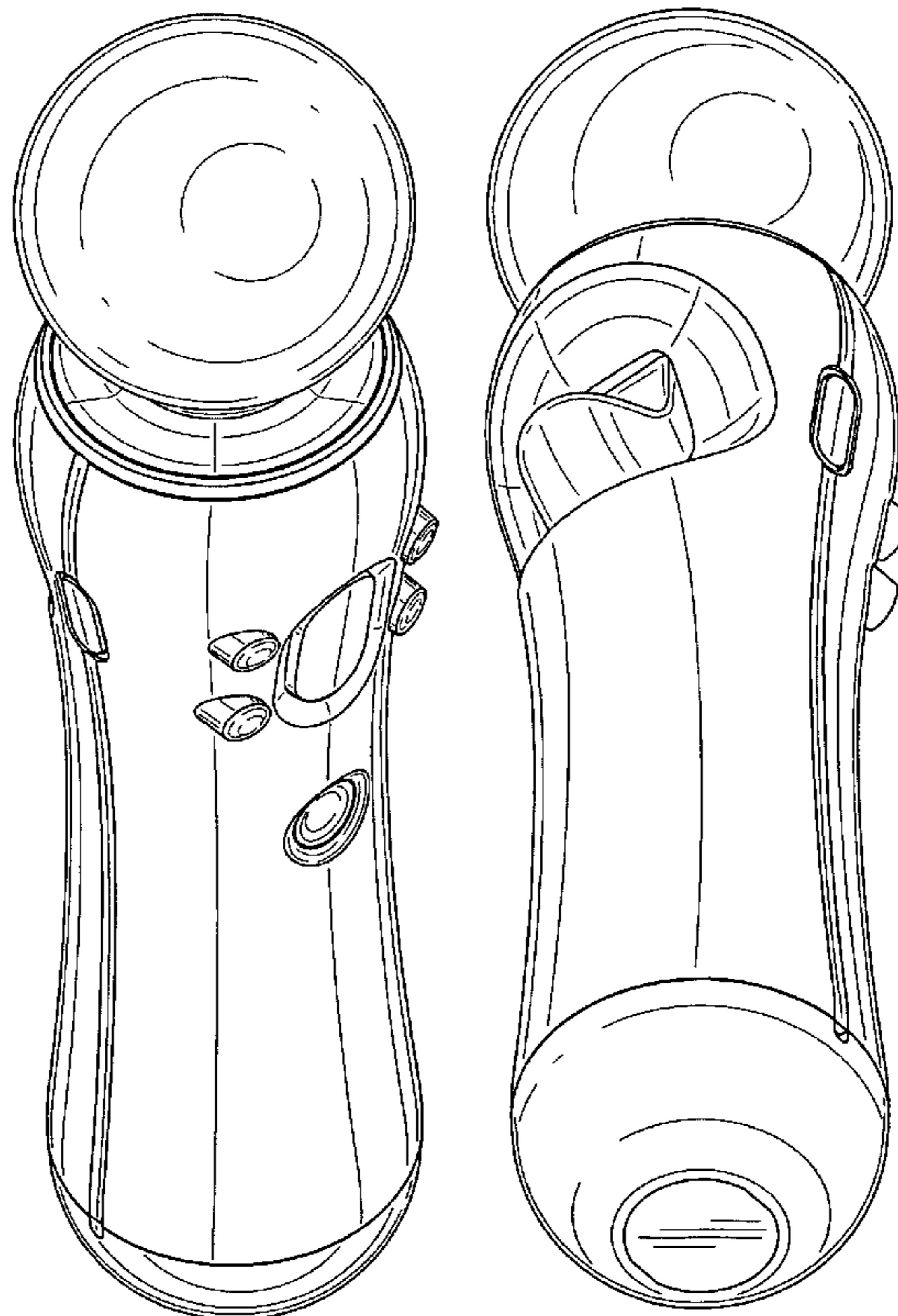

FIG. 1

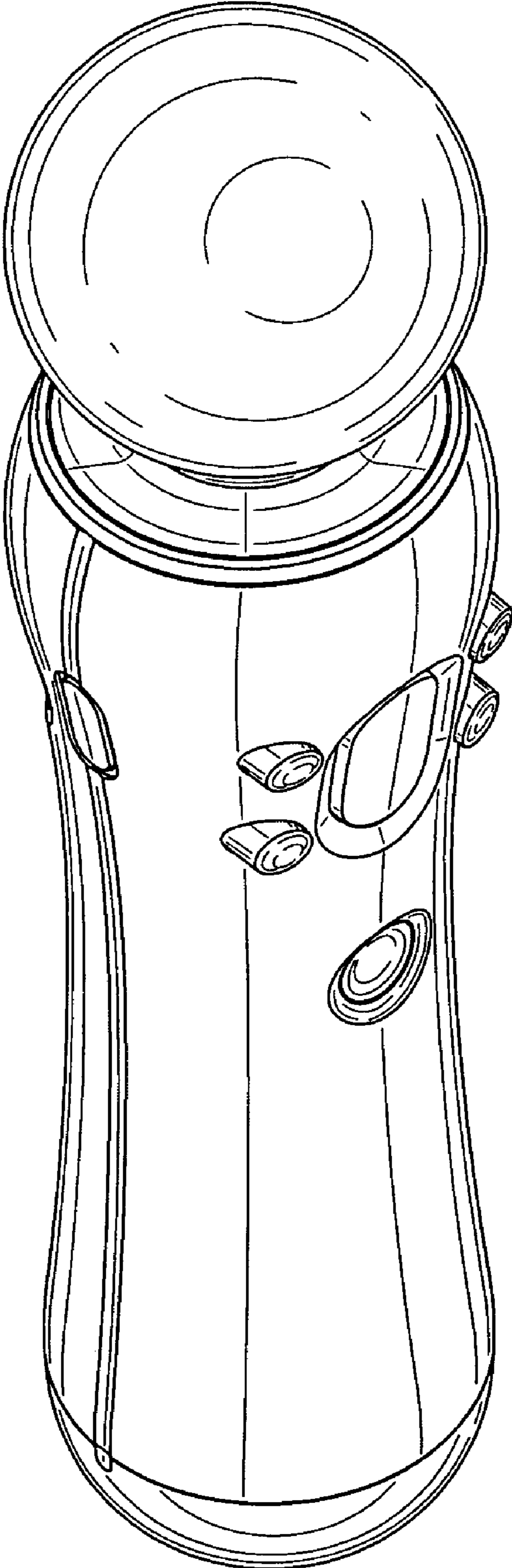

FIG.2



FIG.3

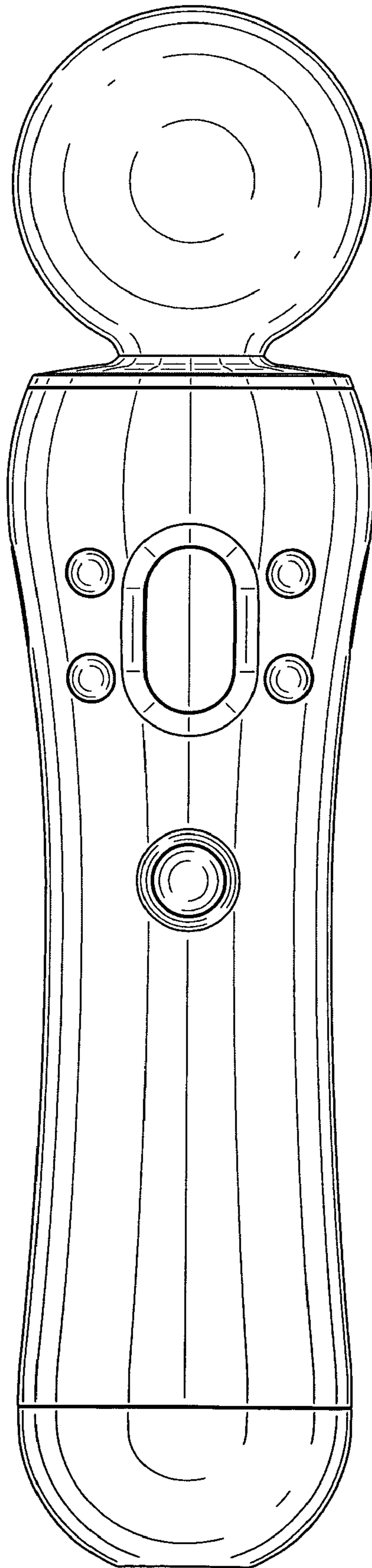

FIG.4

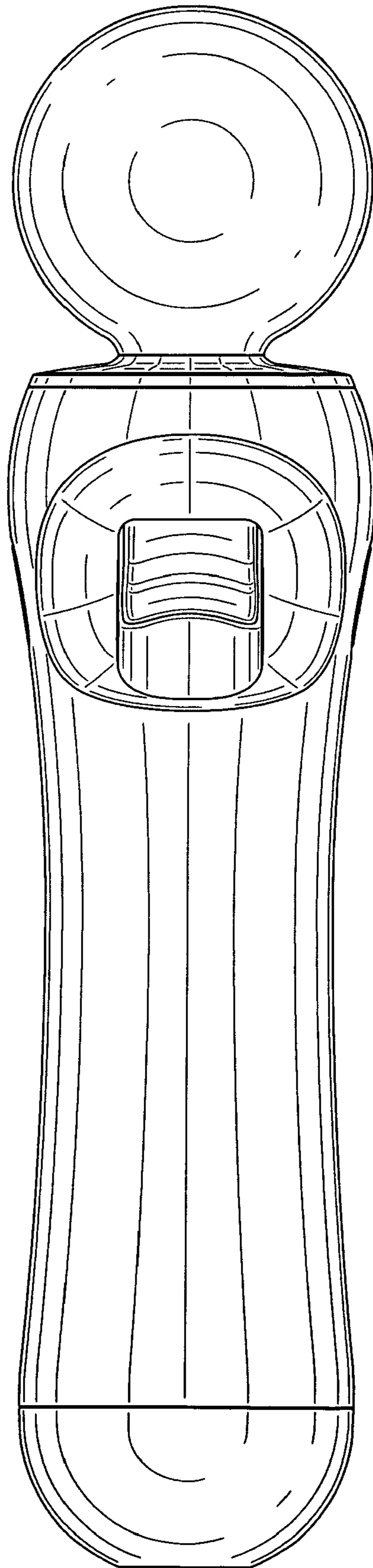

FIG.5

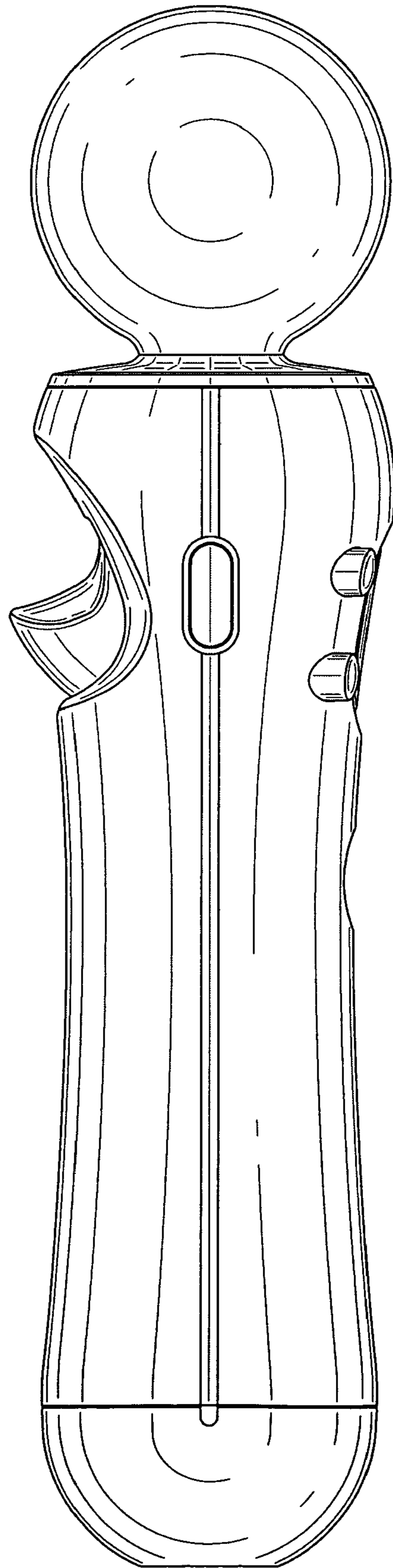

FIG.6

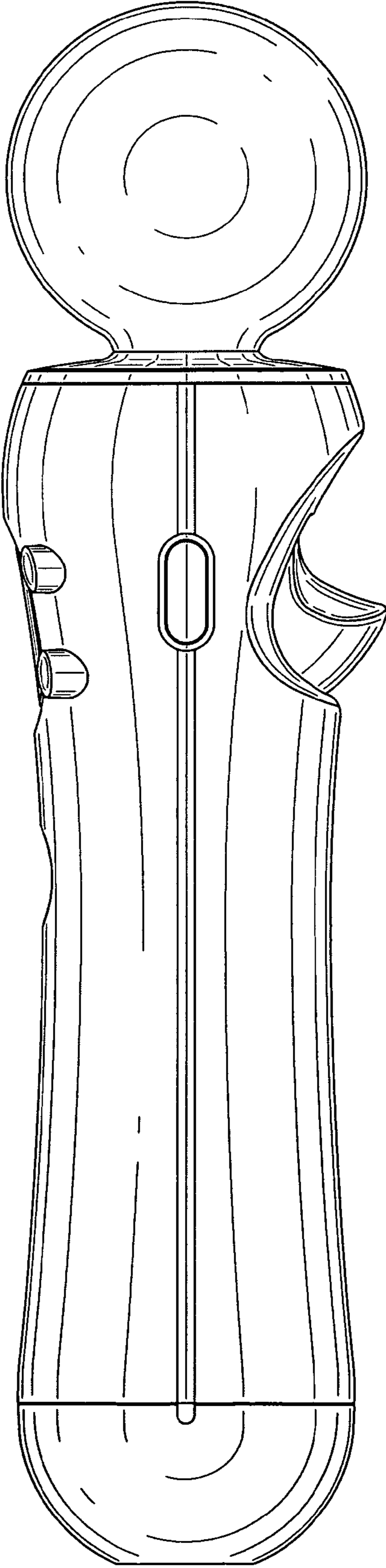

FIG.7

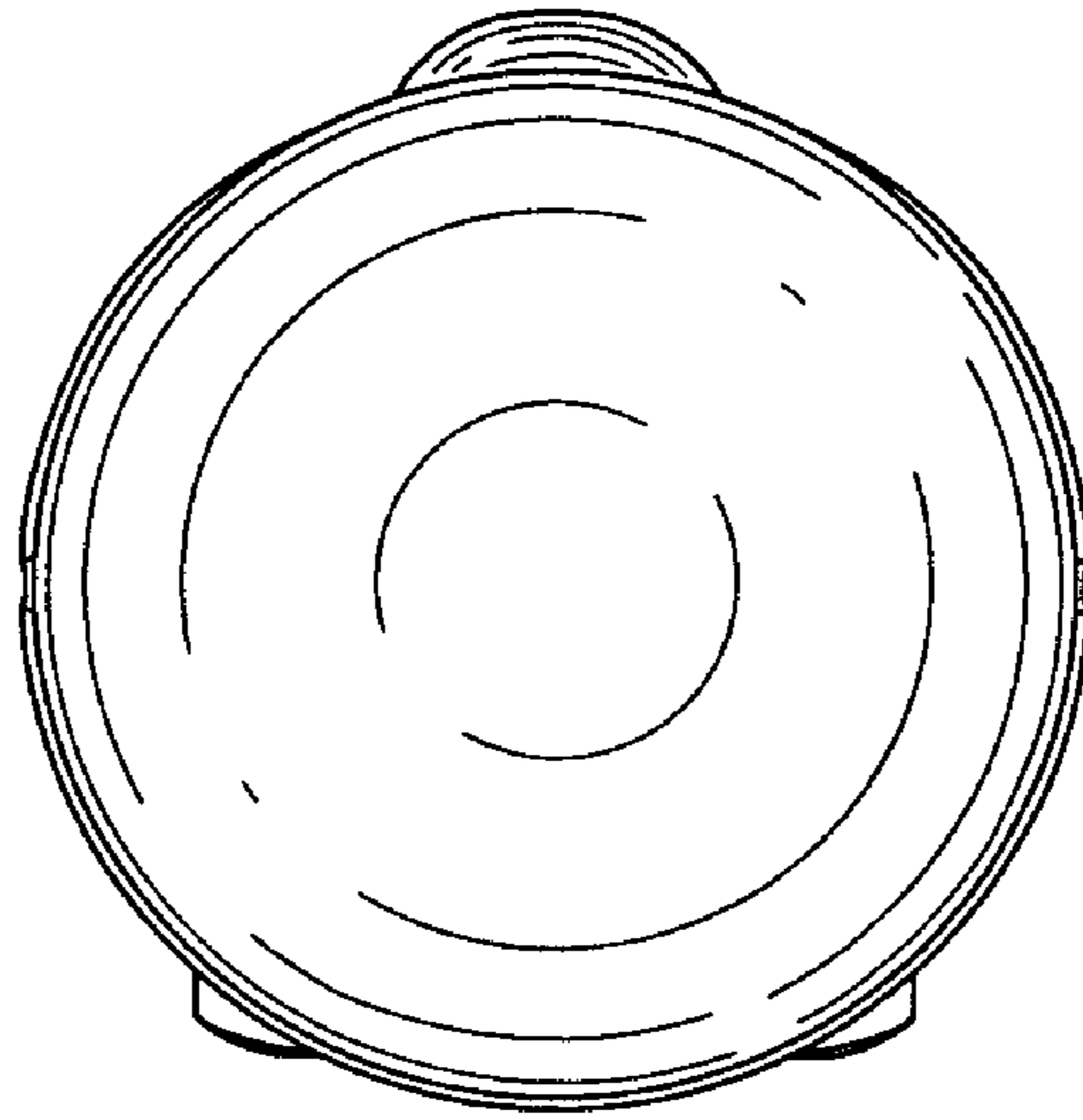

FIG.8

