



US00D627639S

(12) **United States Design Patent**
Ziegler et al.

(10) **Patent No.:** **US D627,639 S**

(45) **Date of Patent:** **** Nov. 23, 2010**

(54) **CONTAINER DISPENSER**

(75) Inventors: **Jan Ziegler**, Köln (DE); **Kai Ruthe-Steinsiek**, Duesseldorf (DE); **Matthias Rhode**, Kaarst (DE); **Birgit Rhode**, legal representative, Kaarst (DE); **Sonja Pfennings**, legal representative, Kaarst (DE)

(73) Assignee: **Henkel AG & Co. KGaA**, Duesseldorf (DE)

(**) Term: **14 Years**

(21) Appl. No.: **29/346,540**

(22) Filed: **Nov. 2, 2009**

(30) **Foreign Application Priority Data**

May 4, 2009 (EM) 001134557

(51) **LOC (9) Cl.** **09-07**

(52) **U.S. Cl.** **D9/448; D9/443**

(58) **Field of Classification Search** D9/456, D9/455, 448, 447, 445, 438, 434, 763, 772; D7/605, 387, 213; D3/211, 207; D23/226; 40/307; 239/333, 331; 222/635, 631, 566, 222/321.9, 321.8, 321.7, 320, 251; 220/915, 220/269, 268, 258.5

See application file for complete search history.

(56) **References Cited**

U.S. PATENT DOCUMENTS

D185,754 S * 7/1959 Jones et al. D9/447
D190,254 S * 5/1961 Trexler D9/447
3,317,092 A * 5/1967 Jurasek 222/402.13

D218,145 S * 7/1970 Dublin D9/685
D331,365 S * 12/1992 Davis D9/447
D349,642 S * 8/1994 Abfier D9/685
D383,065 S * 9/1997 Eastling D9/447
D385,745 S * 11/1997 Valentinitzsch D7/300.1
D407,312 S * 3/1999 Shanklin et al. D9/447
D481,632 S * 11/2003 Masotta et al. D9/447
D524,648 S * 7/2006 Feist et al. D9/447
D586,211 S * 2/2009 Pires et al. D9/447
D601,894 S * 10/2009 Cho et al. D9/447

* cited by examiner

Primary Examiner—Susan Bennett Hattan

(74) *Attorney, Agent, or Firm*—James E. Piotrowski; Steven C. Bauman

(57) **CLAIM**

The ornamental design for a container dispenser, as shown and described.

DESCRIPTION

FIG. 1 is a front elevation view of the container dispenser (shown with a container in broken lines) according to the new design;

FIG. 2 is a back elevation view thereof;

FIG. 3 is a left side elevation view thereof;

FIG. 4 is a right side elevation view thereof;

FIG. 5 is a perspective view thereof;

FIG. 6 is a top plan view thereof; and,

FIG. 7 is a bottom plan view thereof.

The broken lines in the Figures serve the purpose of illustrative example and form no part of the claimed design.

1 Claim, 7 Drawing Sheets

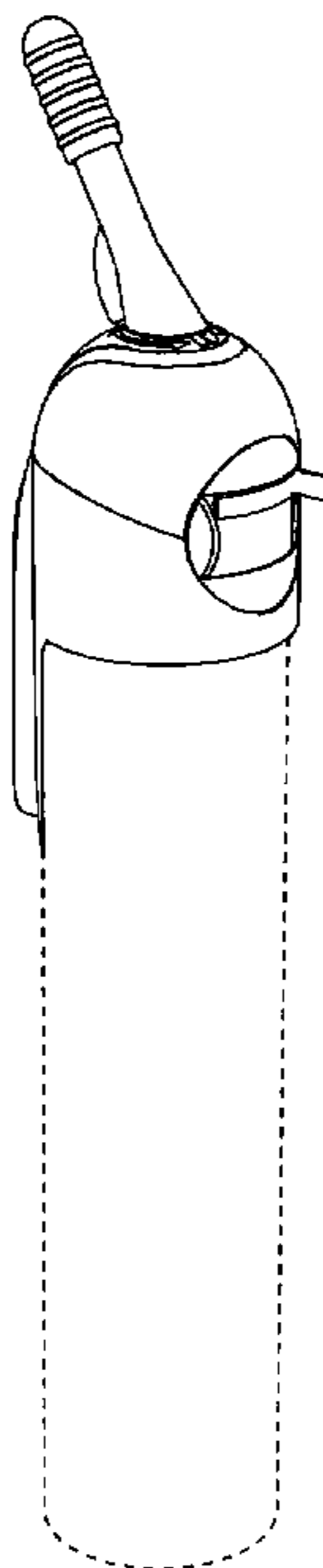

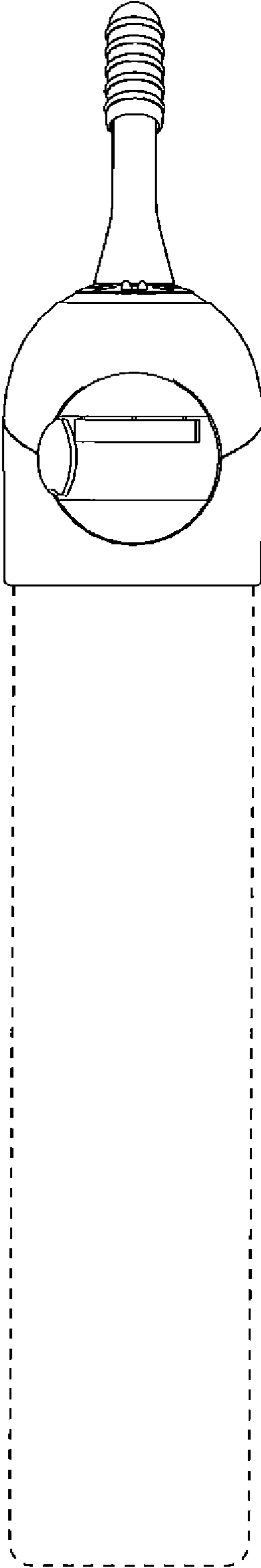

FIG. 1

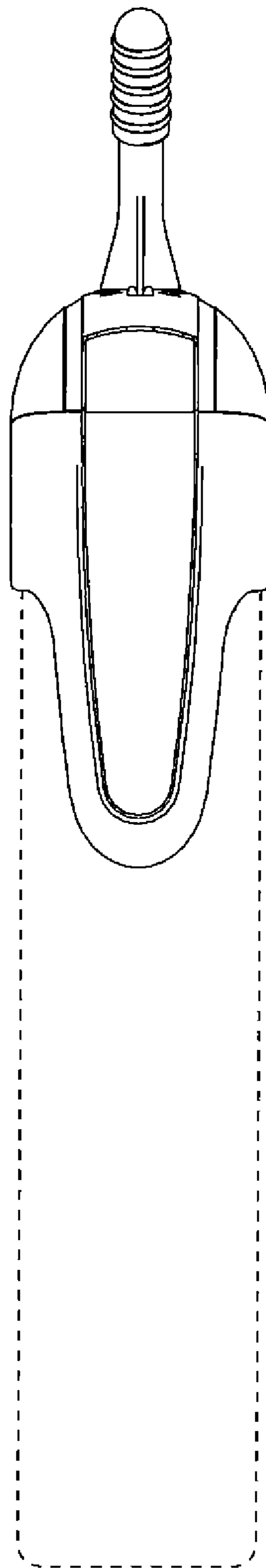

FIG. 2

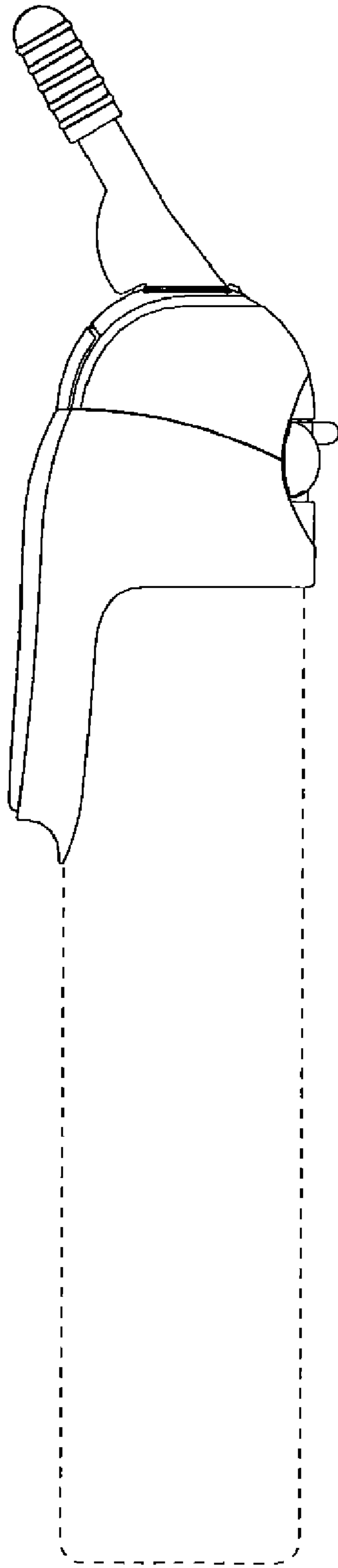

FIG. 3



FIG. 4

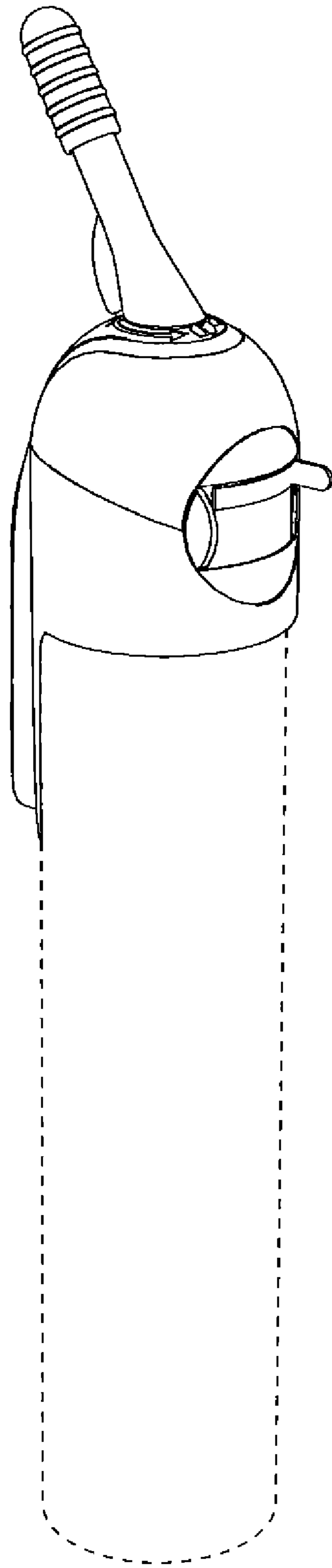

FIG. 5

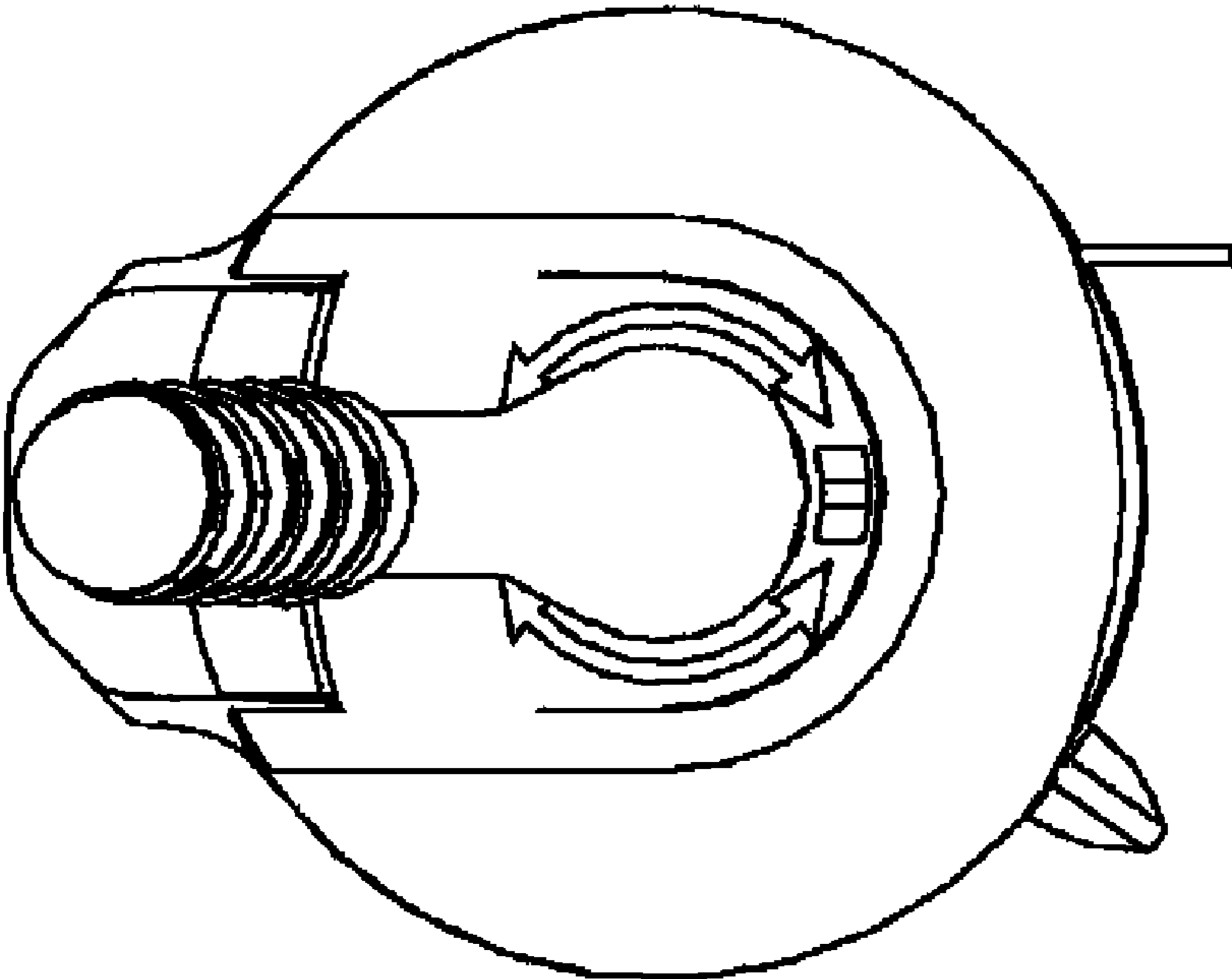

FIG. 6

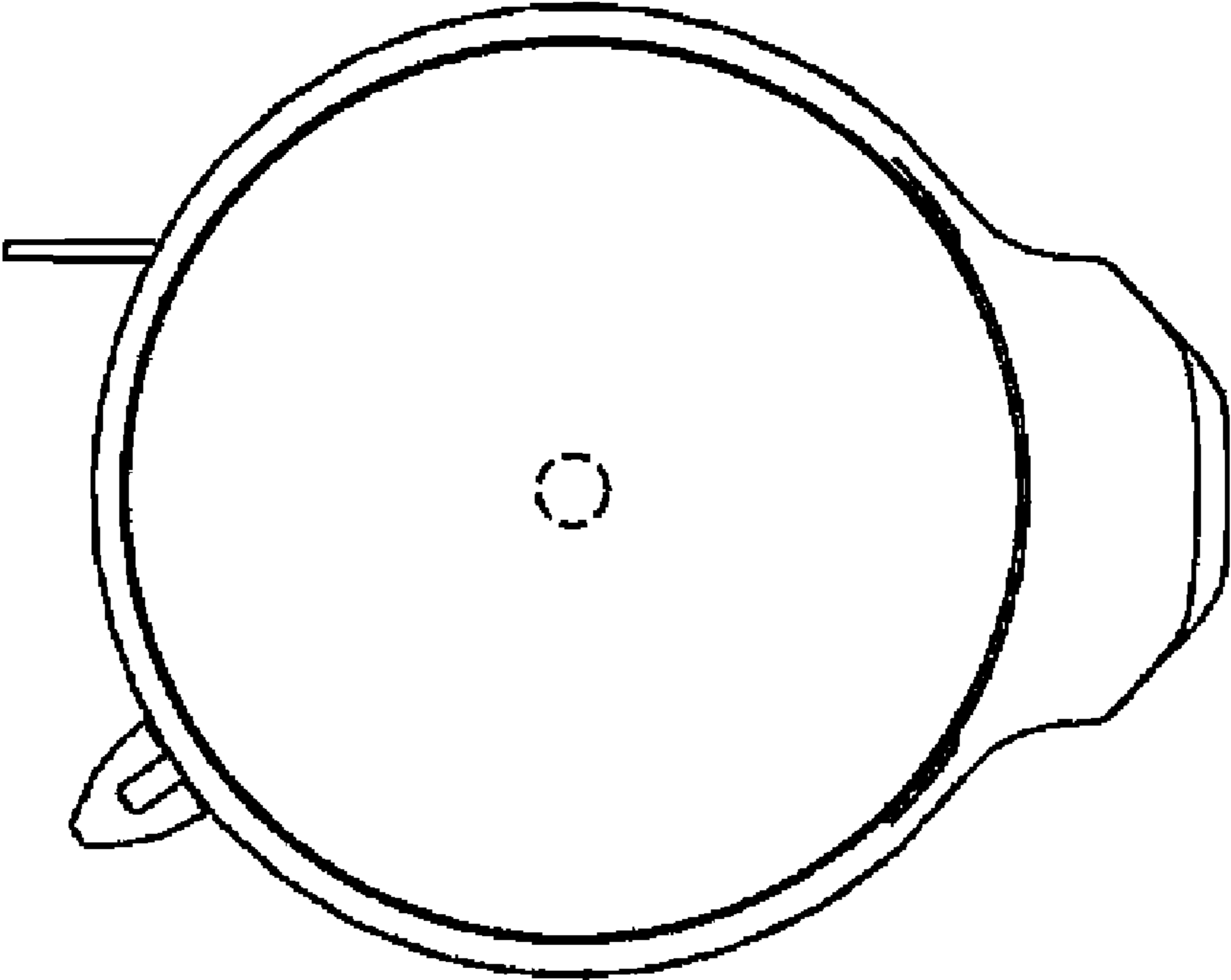

FIG. 7