



US00D627596S

(12) **United States Design Patent**  
**Hillebrenner et al.**

(10) **Patent No.:** **US D627,596 S**  
(45) **Date of Patent:** **\*\* Nov. 23, 2010**

(54) **CUP**

(75) Inventors: **William Hillebrenner**, Chicago, IL  
(US); **Weston Koennecke**, Oak Park, IL  
(US)

(73) Assignee: **Solo Cup Operating Corporation**, Lake  
Forest, IL (US)

(\*\*) Term: **14 Years**

(21) Appl. No.: **29/320,143**

(22) Filed: **Jun. 20, 2008**

**Related U.S. Application Data**

(63) Continuation of application No. 29/320,019, filed on  
Jun. 18, 2008.

(51) **LOC (9) Cl.** ..... **07-01**

(52) **U.S. Cl.** ..... **D7/396.2; D7/509; D7/527**

(58) **Field of Classification Search** ..... **D7/396.4,**  
**D7/396.2, 387, 392.1, 523, 509, 624.1, 532;**  
**D5/7, 99; D9/516, 549, 551; 428/34.4; 229/400;**  
**215/387, 382, DIG. 7; 220/703, 592.16,**  
**220/592.17; 65/69**

See application file for complete search history.

(56) **References Cited**

**U.S. PATENT DOCUMENTS**

703,125	A	6/1902	Emrich	
D42,683	S	7/1912	Anderson	
D68,368	S	10/1925	Bell	
1,636,174	A	7/1927	Dolan et al.	
2,013,243	A	9/1935	Landon	
2,168,186	A	8/1939	Adamson	
D139,564	S	* 11/1944	Byrd et al.	..... D9/551
D163,673	S	6/1951	Bliss	

(Continued)

**FOREIGN PATENT DOCUMENTS**

DE 1175564 8/1964

(Continued)

**OTHER PUBLICATIONS**

Full View Photo of Thermos taken approximately Dec. 11, 2008.

(Continued)

*Primary Examiner*—Robert M Spear

*Assistant Examiner*—Cynthia Underwood

(74) *Attorney, Agent, or Firm*—Banner & Witcoff, Ltd.

(57) **CLAIM**

The ornamental design for a cup, as shown and described.

**DESCRIPTION**

FIG. 1 is a perspective view showing a first embodiment of  
our new design of a cup;

FIG. 2 is a front view thereof;

FIG. 3 is a top view thereof;

FIG. 4 is a side view thereof;

FIG. 5 is a bottom view thereof;

FIG. 6 is a perspective view showing a second embodiment of  
our new design of a cup;

FIG. 7 is a front view thereof;

FIG. 8 is top view thereof;

FIG. 9 is a side view thereof;

FIG. 10 is a bottom view thereof;

FIG. 11 is a perspective view showing a third embodiment of  
our new design of a cup;

FIG. 12 is a front view thereof;

FIG. 13 is a top view thereof;

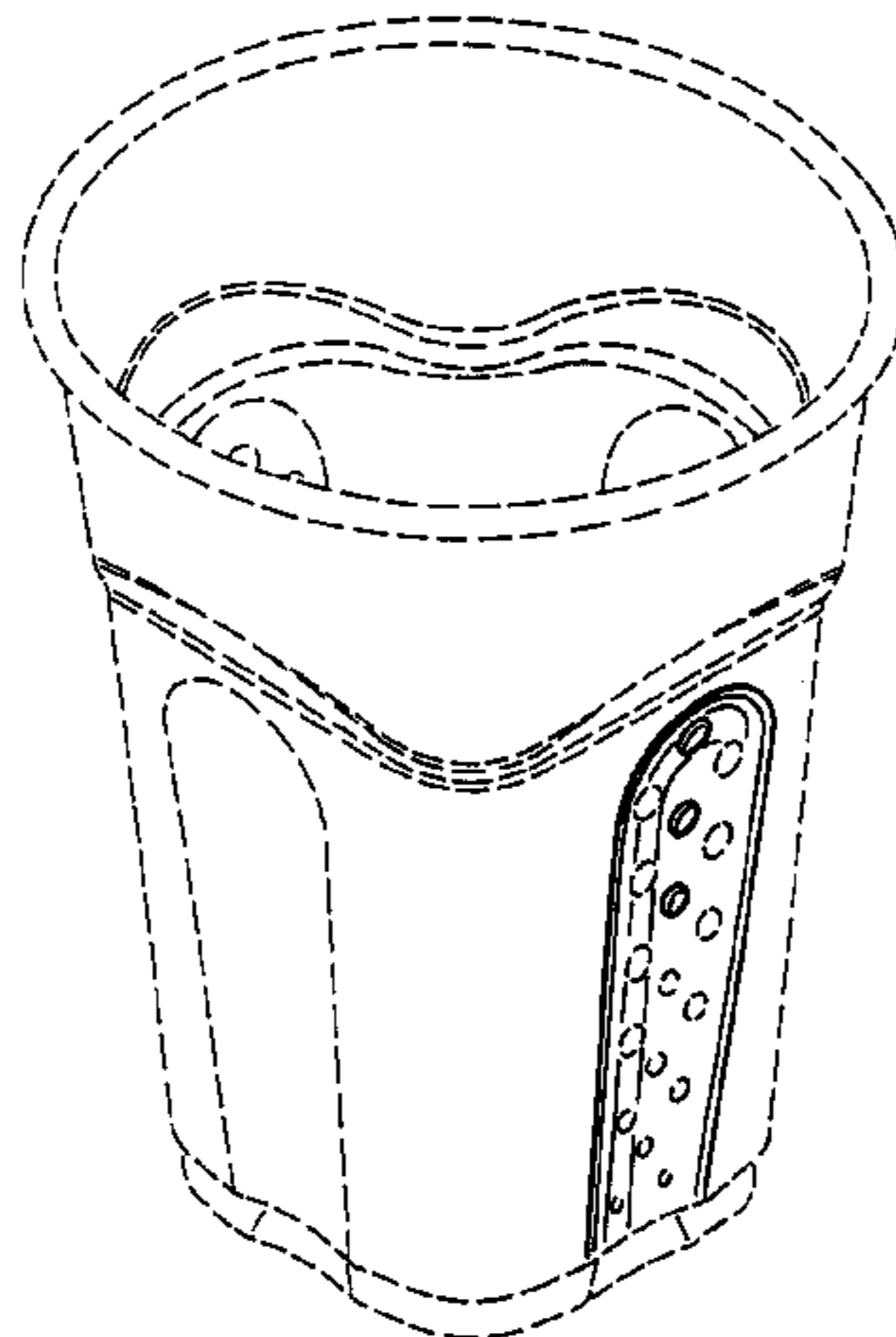
FIG. 14 is a side view thereof; and,

FIG. 15 is a bottom view thereof.

The dash-dot-dash broken lines shown in the drawings rep-  
resent unclaimed boundaries of the claimed design.

The broken lines represent portions of the design that form no  
part of the claim.

**1 Claim, 9 Drawing Sheets**



**US D627,596 S**

Page 2

U.S. PATENT DOCUMENTS							
				6,152,363	A *	11/2000	Rule, Jr. .... 229/403
2,629,534	A	2/1953	Reynolds	D436,295	S	1/2001	Furman et al.
2,731,189	A	1/1956	Moore	D441,252	S	5/2001	Gitschlag
2,745,586	A	5/1956	Thoma	D443,475	S	6/2001	Miura
2,905,350	A	9/1959	Edwards	D444,672	S	7/2001	Miura
3,009,603	A	11/1961	Stockdale	6,264,068	B1	7/2001	Ours et al.
3,085,730	A	4/1963	Fibish	D446,684	S	8/2001	Price
3,091,360	A	5/1963	Edwards	D446,687	S	8/2001	Furman et al.
D196,271	S	9/1963	Edwards	D448,976	S	10/2001	McDonough et al.
D197,313	S	1/1964	Wanderer	6,311,861	B1 *	11/2001	Policappelli ..... 220/669
3,126,139	A	3/1964	Schechter	D457,783	S *	5/2002	Bodum ..... D7/511
D198,139	S	5/1964	Edwards	D460,696	S	7/2002	Goettner
3,131,845	A	5/1964	Sherlock et al.	D461,368	S *	8/2002	Durand ..... D7/523
3,139,213	A	6/1964	Edwards	D462,270	S	9/2002	Renz
D199,336	S	10/1964	Wanderer	D471,240	S *	3/2003	Hanson et al. .... D20/28
D199,579	S	11/1964	Davis	6,554,154	B1	4/2003	Chauhan et al.
D204,947	S	5/1966	Benjamin	6,575,321	B2	6/2003	Bourque et al.
3,288,340	A	11/1966	Etal	D484,362	S	12/2003	Harris et al.
D206,889	S *	2/1967	Benes ..... D7/523	D488,384	S	4/2004	Murphy
3,342,370	A	9/1967	Johnson	6,722,514	B2	4/2004	Renz
D208,872	S	10/1967	Davis	D490,223	S *	5/2004	McClaskie ..... D2/954
D210,067	S	2/1968	Abe	6,749,075	B2	6/2004	Bourque et al.
D210,767	S	4/1968	Anlada	D499,934	S	12/2004	Smith et al.
D210,853	S	4/1968	Anderson	D499,935	S	12/2004	Smith et al.
3,375,954	A	4/1968	Honkanen et al.	D502,877	S	3/2005	Stockwell et al.
D211,514	S	6/1968	Amberg	D504,593	S	5/2005	Smith et al.
3,397,867	A	8/1968	van't Hoff	D505,830	S	6/2005	Smith et al.
D213,094	S	1/1969	Davis	D508,372	S	8/2005	Martinez-Lopez
D213,173	S	1/1969	Lockhart et al.	D510,679	S	10/2005	Smith et al.
D213,174	S	1/1969	Davis	D511,647	S	11/2005	Smith et al.
3,437,253	A	4/1969	Davis et al.	D511,932	S	11/2005	Smith et al.
3,519,165	A	7/1970	Hawley	D512,326	S	12/2005	Stockwell et al.
D220,031	S	3/1971	Donovan	D514,380	S	2/2006	Smith et al.
D223,999	S	6/1972	Klose	D514,385	S	2/2006	Smith et al.
D228,125	S	8/1973	Weiss	D514,884	S	2/2006	Smith et al.
D229,008	S	11/1973	Bateman	D515,358	S	2/2006	Orr et al.
D239,358	S	3/1976	Kjellqvist	7,004,342	B2	2/2006	Bourque et al.
3,951,266	A	4/1976	Brewer	D516,378	S	3/2006	Smith et al.
4,049,187	A	9/1977	Florian	D518,333	S *	4/2006	Gluck ..... D7/523
4,052,037	A	10/1977	Mair et al.	D519,036	S	4/2006	Stockwell et al.
4,061,782	A	12/1977	Baxter	D519,786	S	5/2006	Betras
4,102,454	A	7/1978	Karevaara	D521,318	S	5/2006	Huang
4,134,492	A	1/1979	Lucas	D521,803	S	5/2006	Bieger
4,169,537	A	10/1979	Sabreen et al.	D526,841	S	8/2006	Webb
4,245,685	A	1/1981	Nemitz et al.	D526,847	S	8/2006	Freeman
4,420,081	A	12/1983	Dart	D527,583	S	9/2006	Freeman
D272,794	S	2/1984	Dart	D528,863	S	9/2006	Hayes et al.
4,548,348	A	10/1985	Clements	D529,340	S	10/2006	Laib et al.
4,578,296	A	3/1986	Mykazaki et al.	7,185,783	B1	3/2007	Miller
D285,032	S	8/1986	Alonzo	7,213,719	B2	5/2007	Pedmo et al.
D293,869	S	1/1988	Durand	D545,625	S	7/2007	Webb
D320,455	S	10/1991	Malcolm	D547,659	S *	7/2007	Heisner ..... D9/516
D320,859	S	10/1991	Malcolm	D548,528	S *	8/2007	Cha et al. .... D7/523
5,082,135	A	1/1992	DeCoster	D559,039	S	1/2008	Freeman
D328,014	S	7/1992	DeCoster et al.	D559,040	S	1/2008	Freeman
D333,704	S	3/1993	Malcolm	D563,230	S *	3/2008	Watts ..... D9/538
D346,308	S	4/1994	Cautereels et al.	D577,596	S *	9/2008	Snyder et al. .... D9/551
5,346,095	A	9/1994	Deal	D589,300	S *	3/2009	Altiner et al. .... D7/566
5,413,244	A	5/1995	Ramsey	D589,815	S *	4/2009	Hazelton et al. .... D9/601
5,415,339	A	5/1995	Howard	D591,110	S *	4/2009	Koehler ..... D7/523
5,423,160	A	6/1995	Rosen	2003/0157224	A1	8/2003	Westerhof et al.
D368,234	S	3/1996	Dickinson et al.	2004/0045974	A1	3/2004	Gruber et al.
5,634,569	A	6/1997	DeCoster	2005/0061821	A1	3/2005	Smith et al.
5,678,726	A	10/1997	Porteous	2006/0076395	A1	4/2006	Hayes et al.
D387,619	S	12/1997	Gross et al.	2006/0091102	A1	5/2006	Bourque et al.
D399,099	S	10/1998	Cousins	2006/0207962	A1	9/2006	Coley, Jr. et al.
D407,270	S	3/1999	Wilson	2006/0243699	A1	11/2006	Smith
D410,174	S	5/1999	Sheu				
D413,067	S	8/1999	Haley				
D416,757	S	11/1999	Ginuntoli				
6,109,518	A	8/2000	Mueller et al.	DE	1216139	5/1966	
D433,337	S	11/2000	Cautereels	DE	4419161	12/1995	
				DE	29802377	6/1998	

FOREIGN PATENT DOCUMENTS

# US D627,596 S

Page 3

---

EP	0371918	6/1990
FR	2207836	6/1974
GB	395996	7/1933
GB	1096451	12/1967
GB	1251595	10/1971
GB	1461394	1/1977

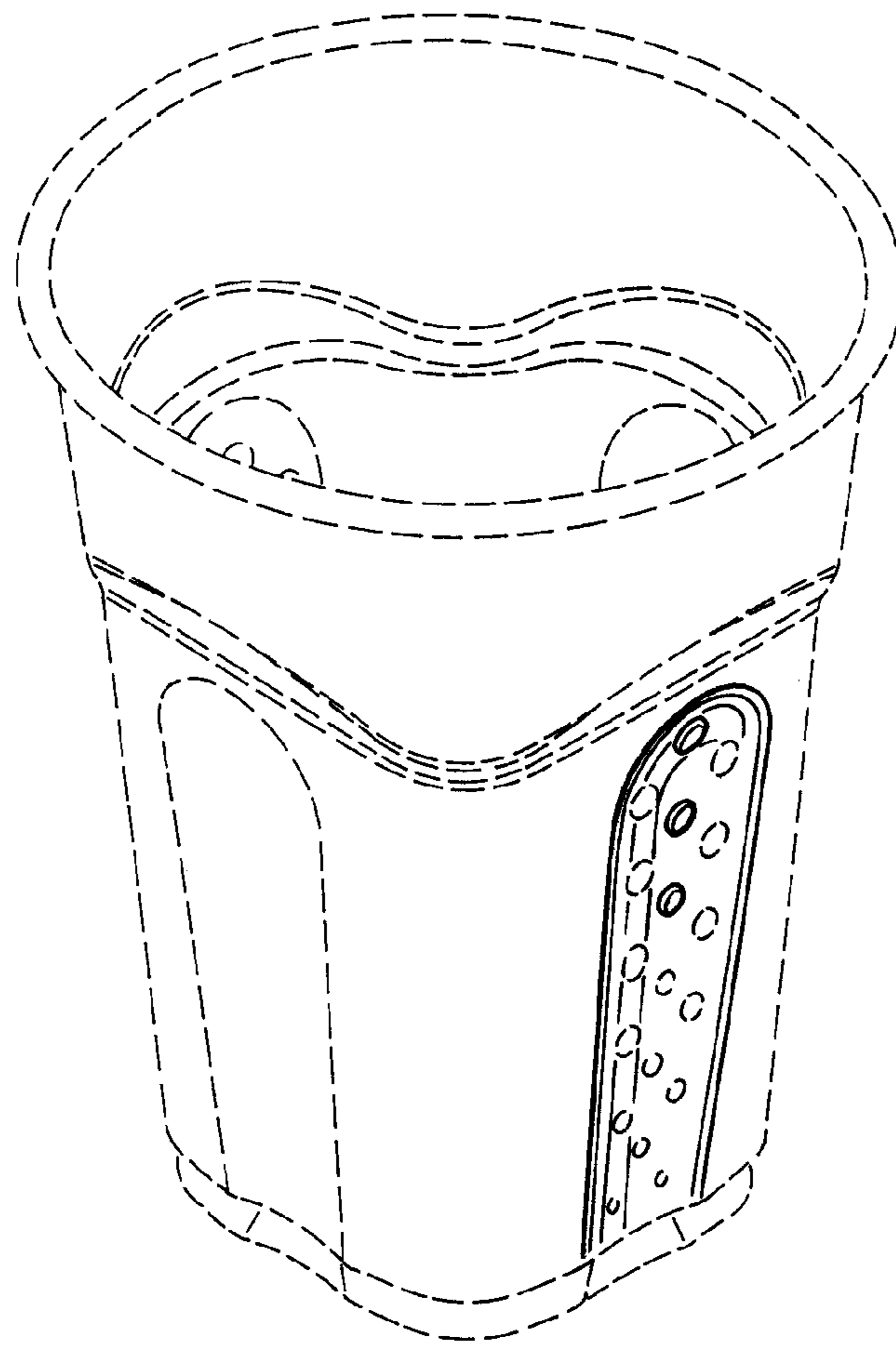
GB	2352612	2/2001
----	---------	--------

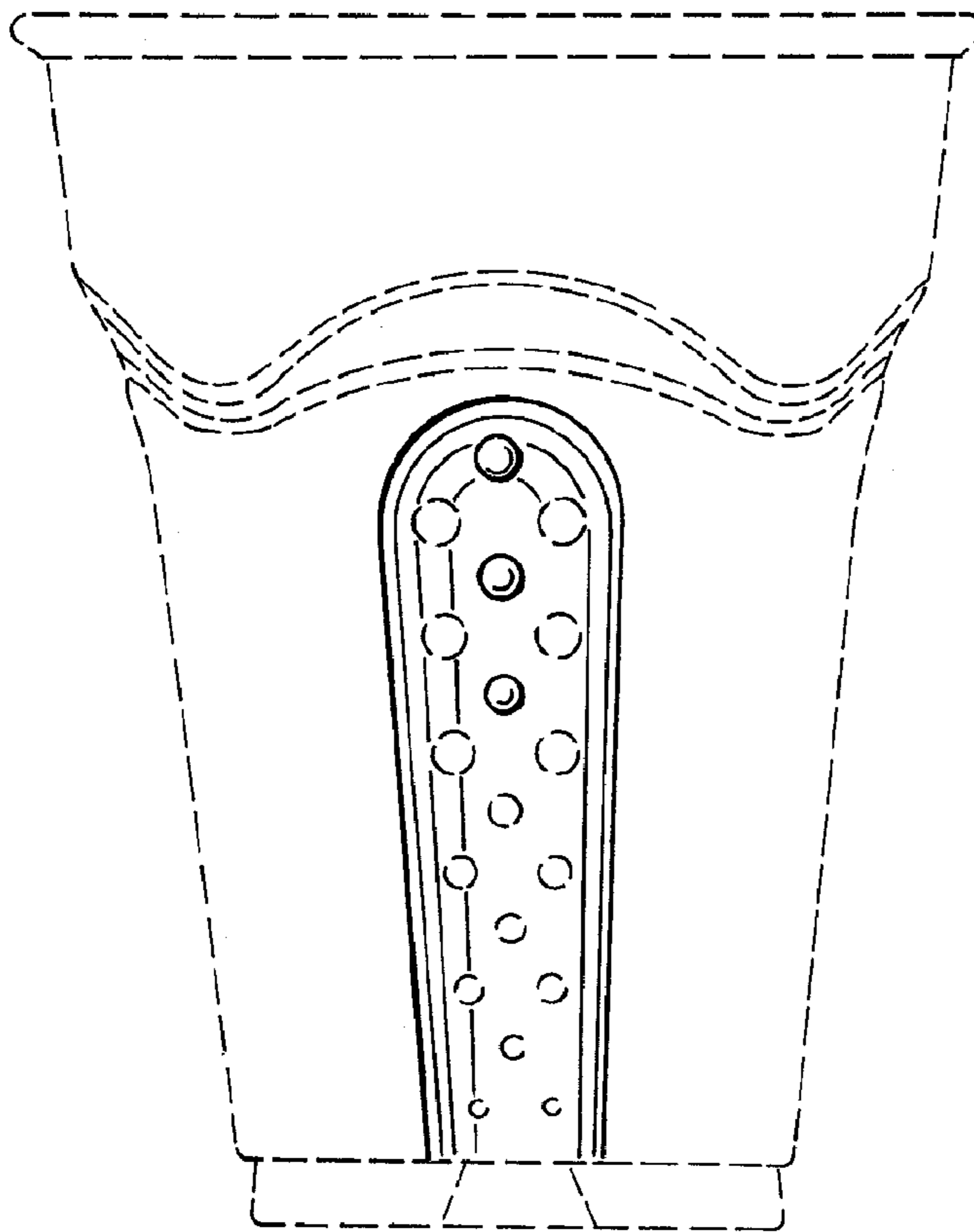
## OTHER PUBLICATIONS

Partial View Photo of Thermos taken approximately Dec. 11, 2008.

\* cited by examiner

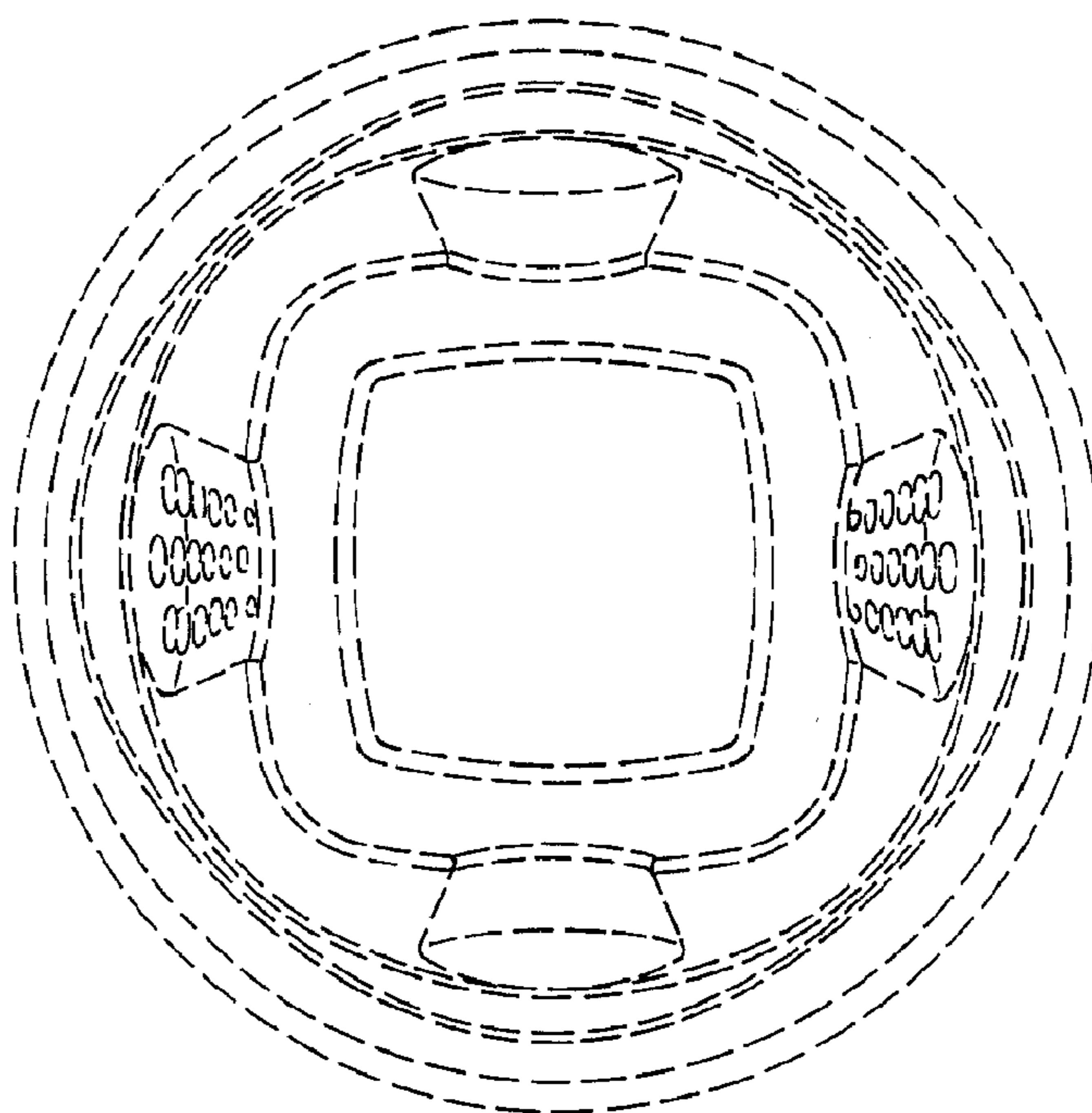
**FIG. 1**

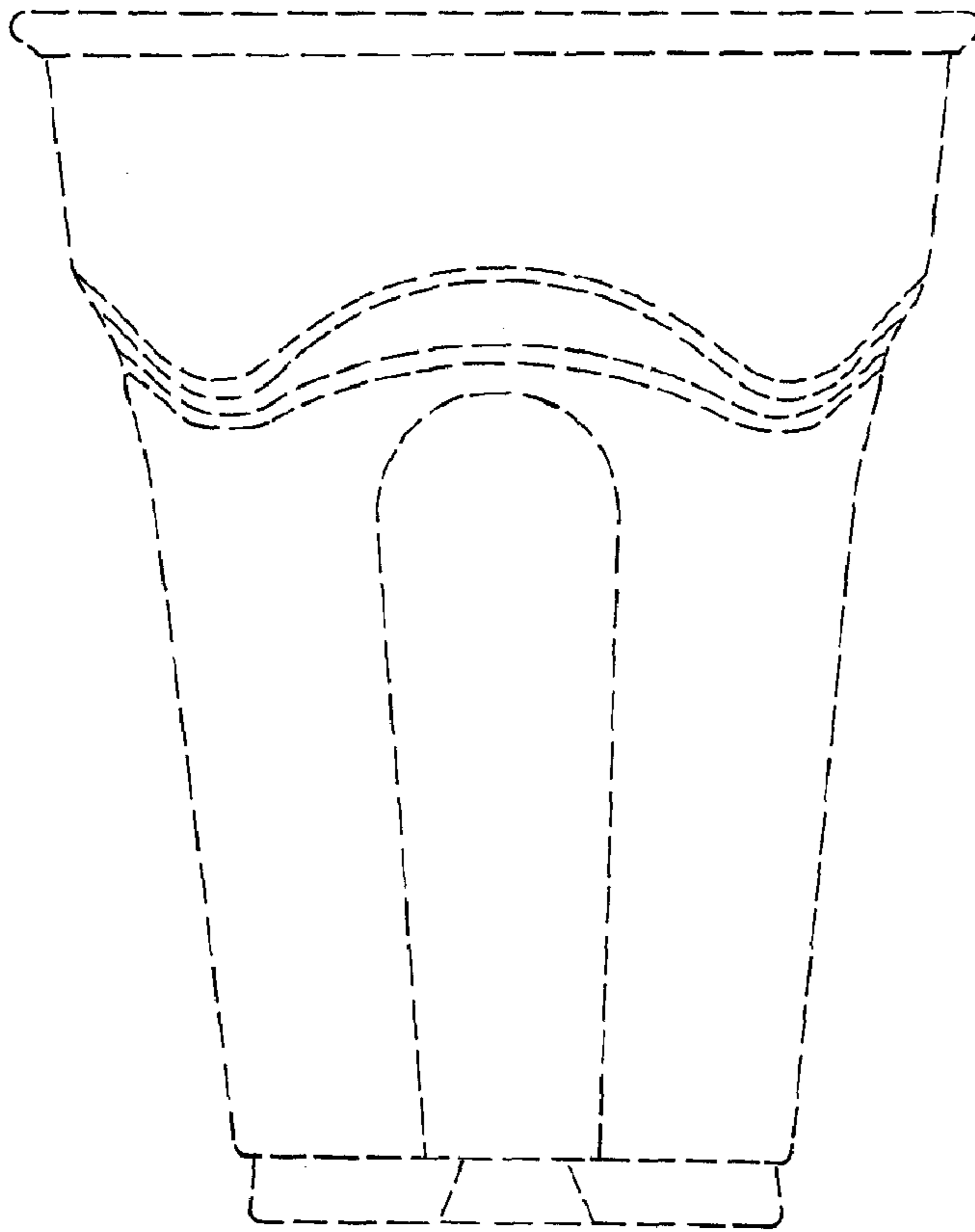




**FIG. 2**

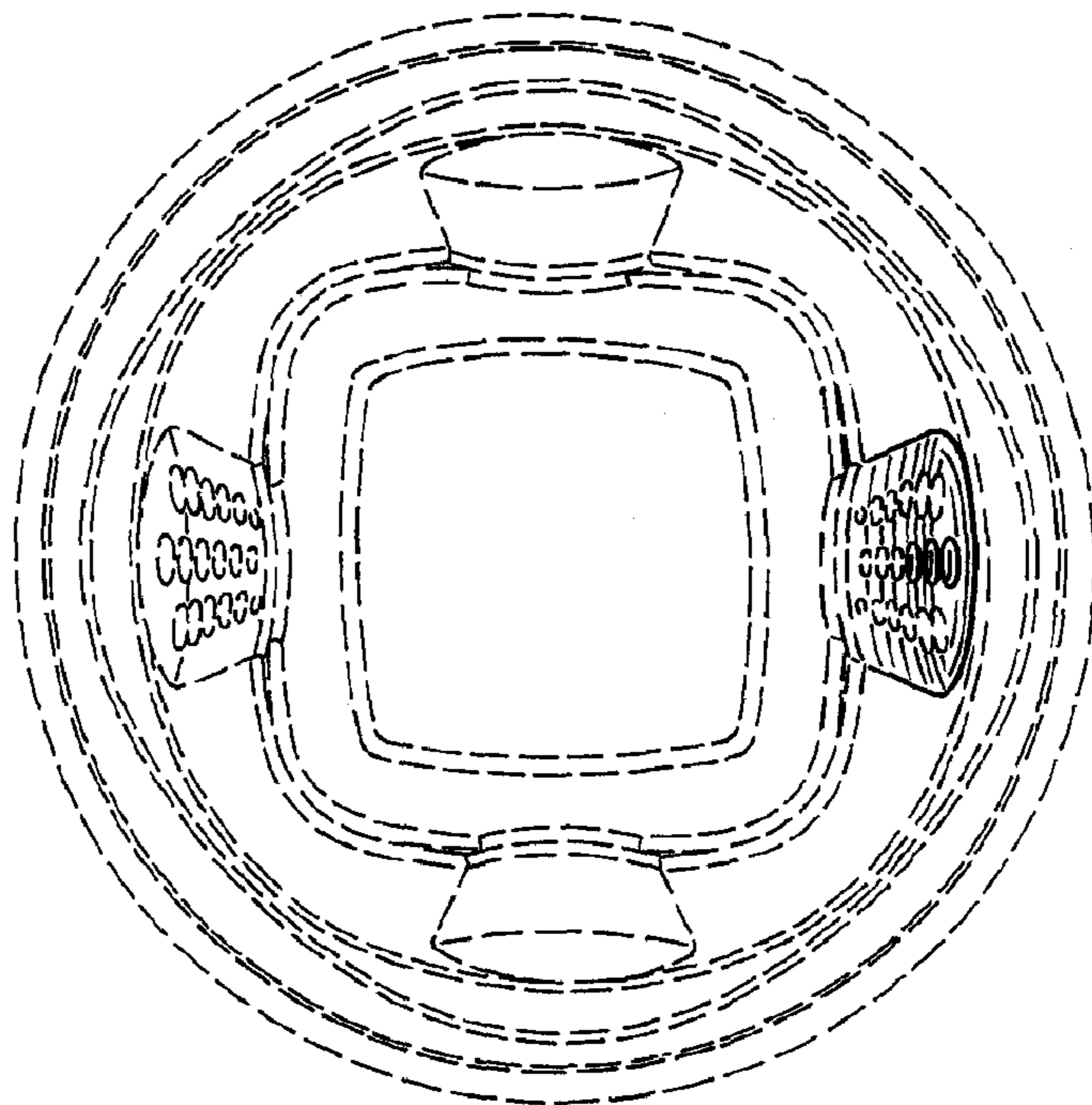
**FIG. 3**



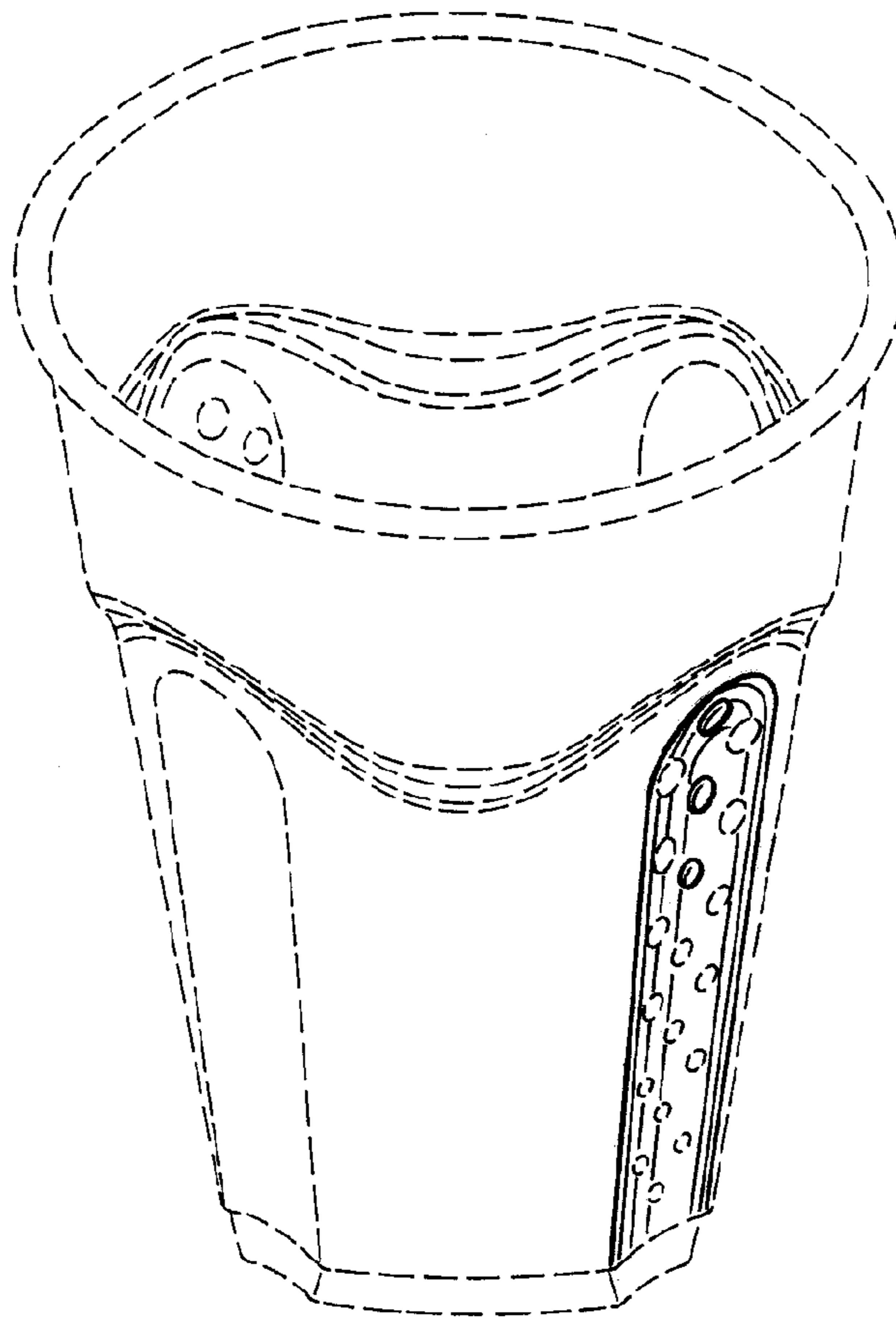


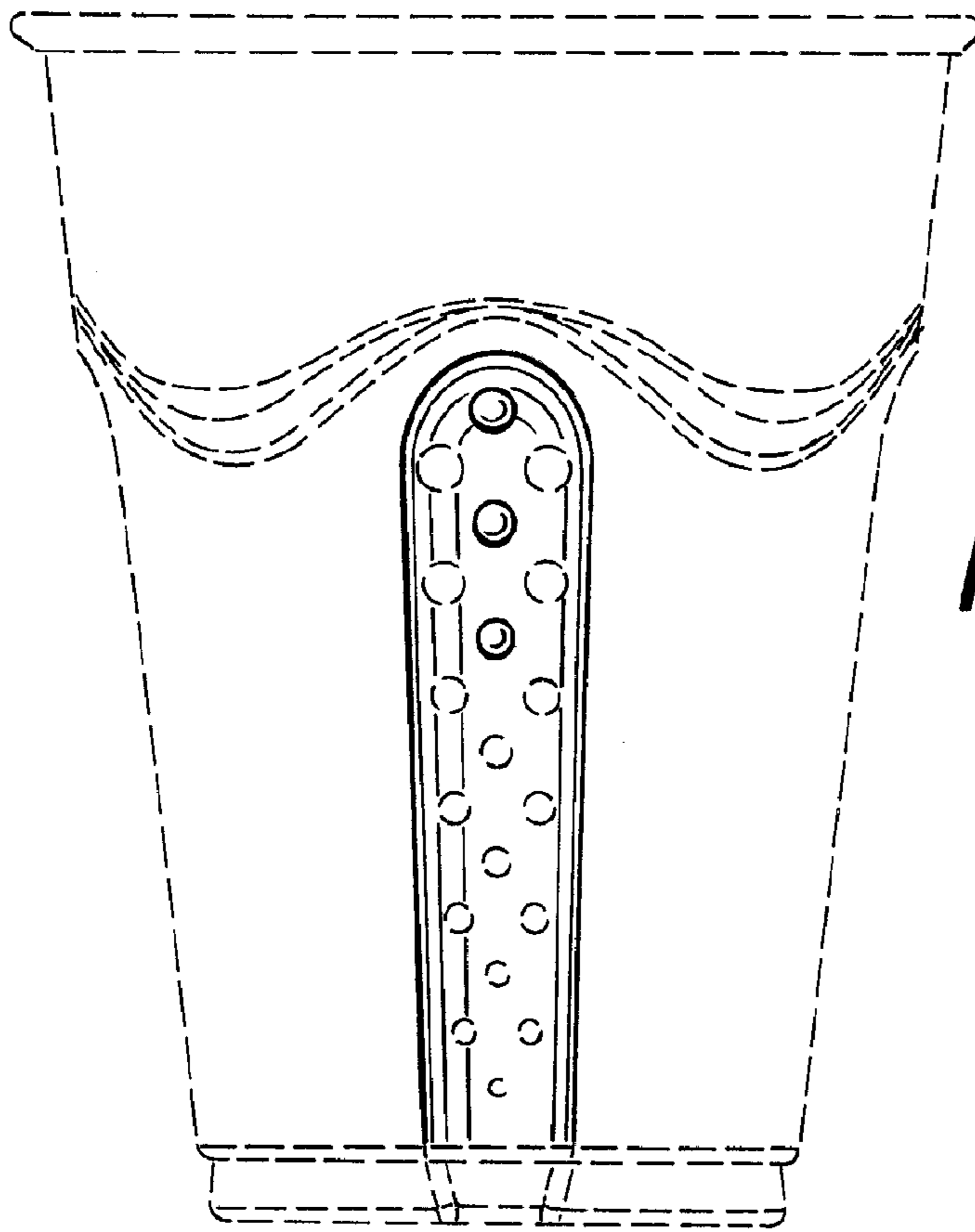
**FIG. 4**

**FIG. 5**



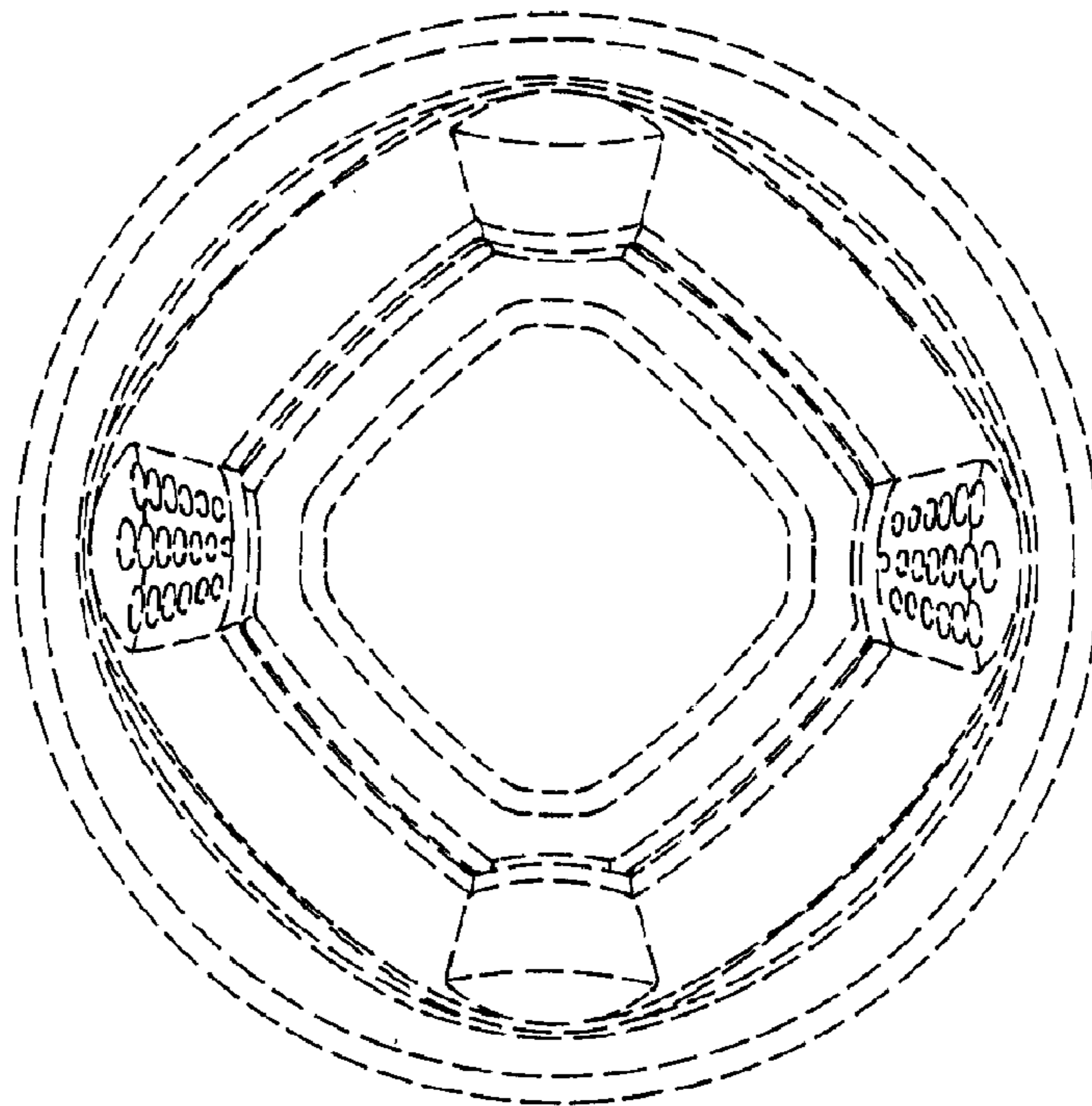
**FIG. 6**



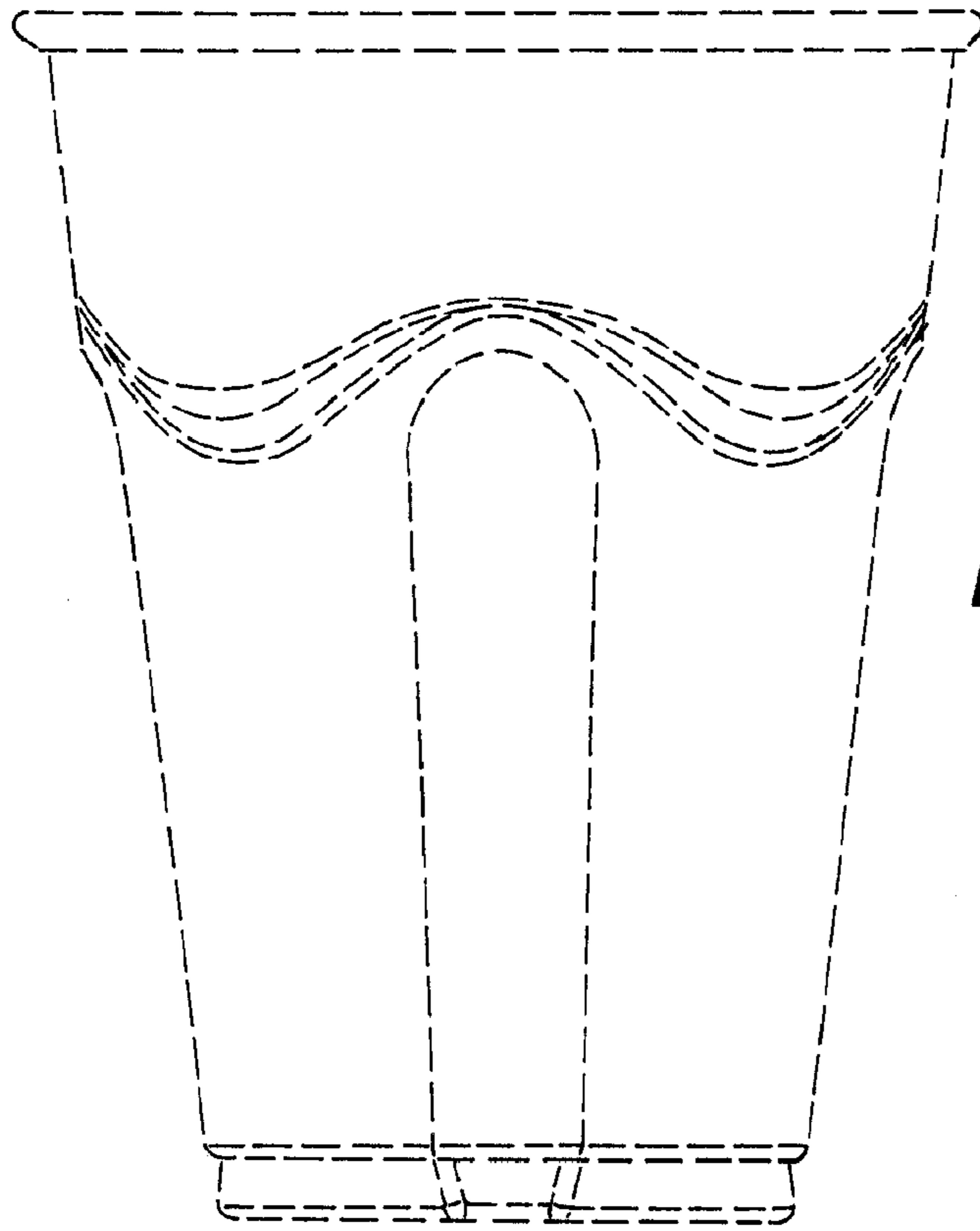


**FIG. 7**

**FIG. 8**

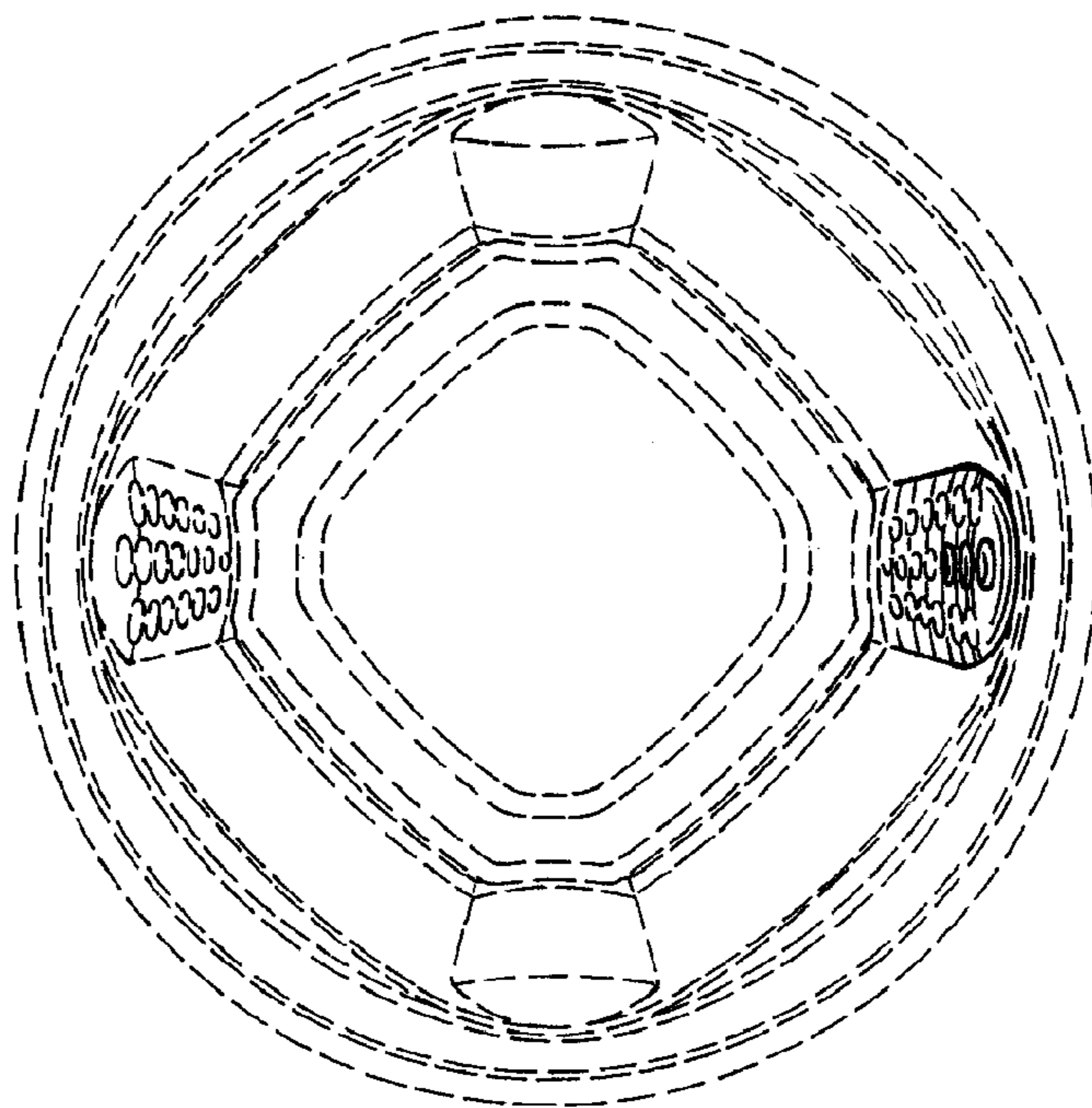




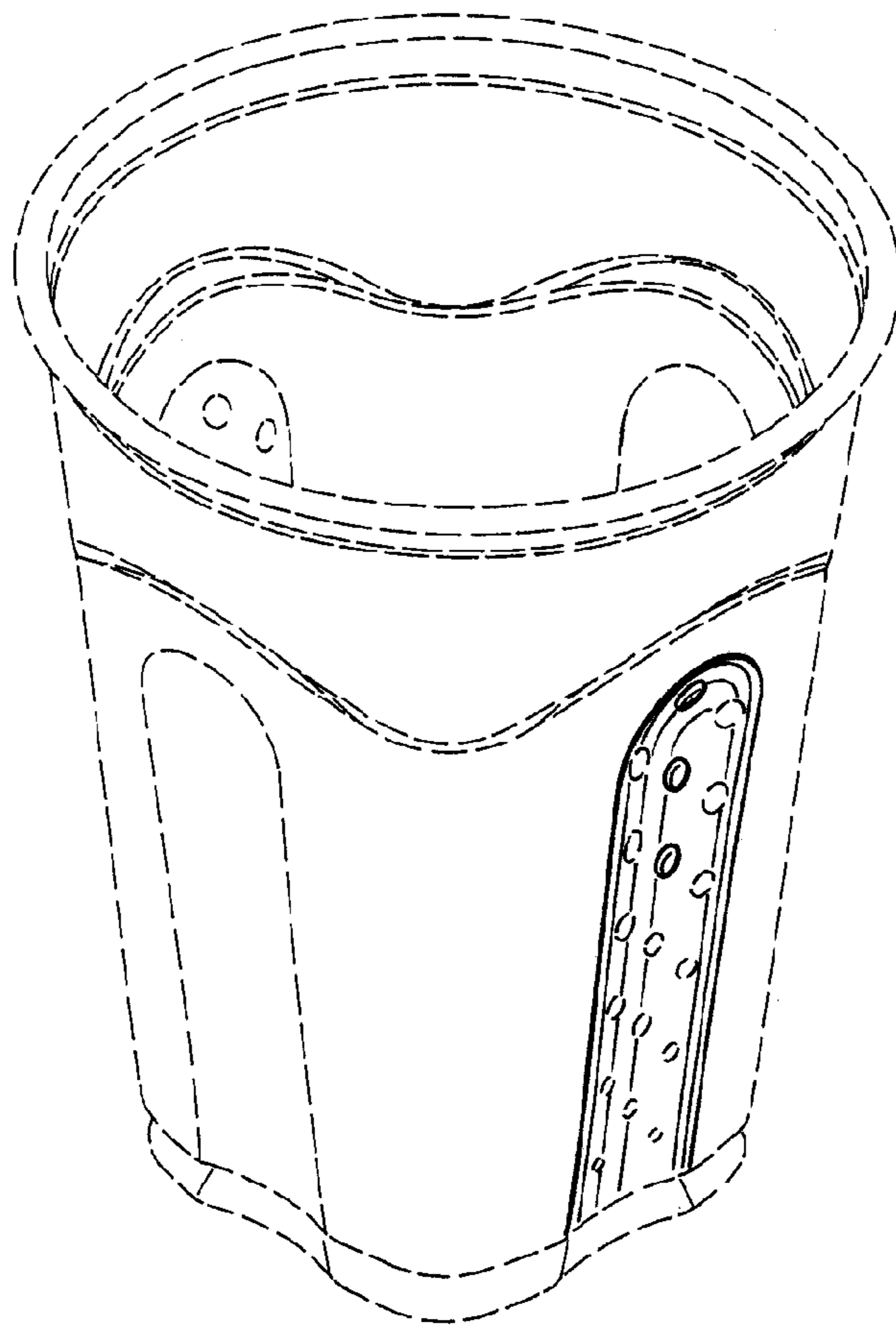


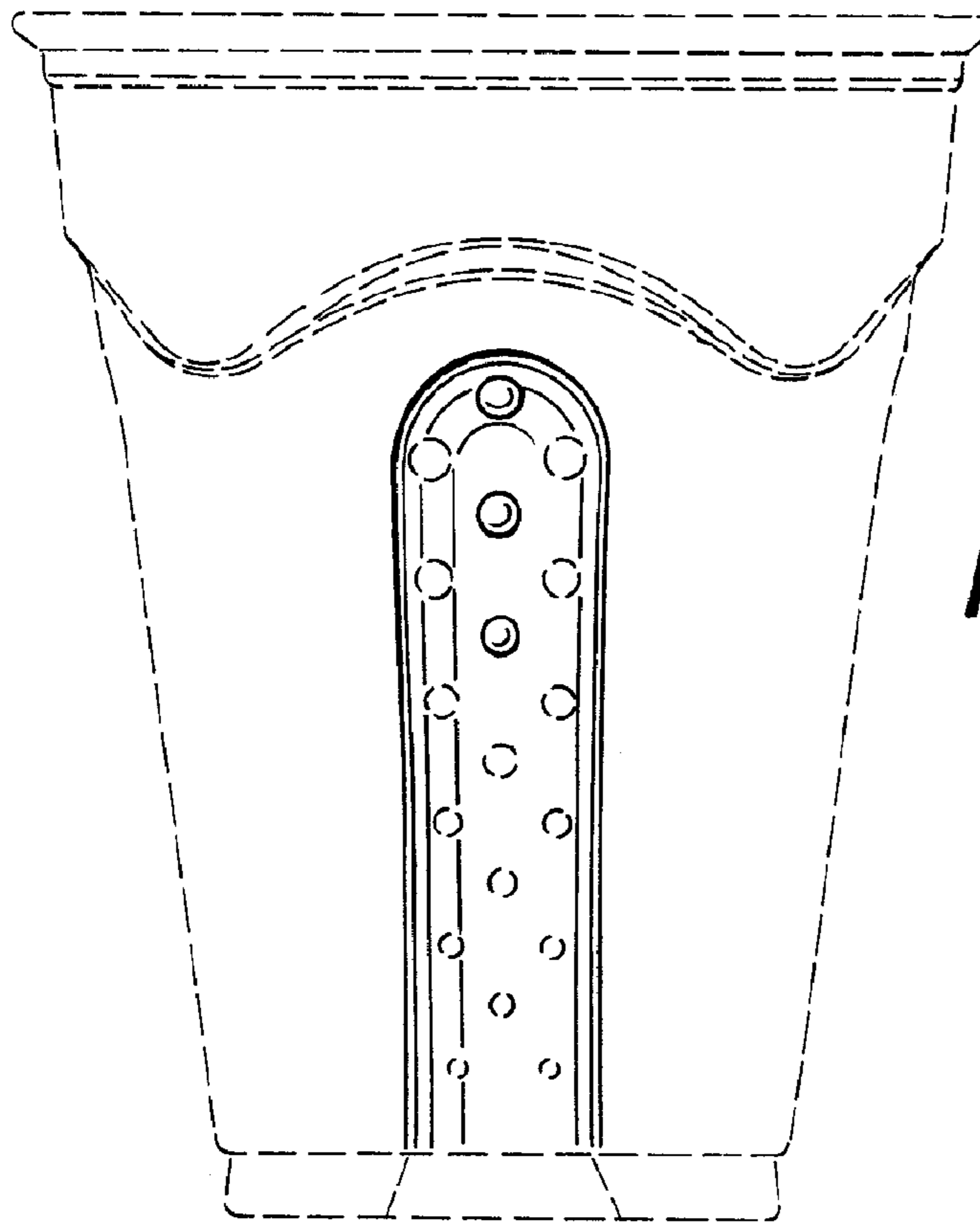
**FIG. 9**

**FIG. 10**



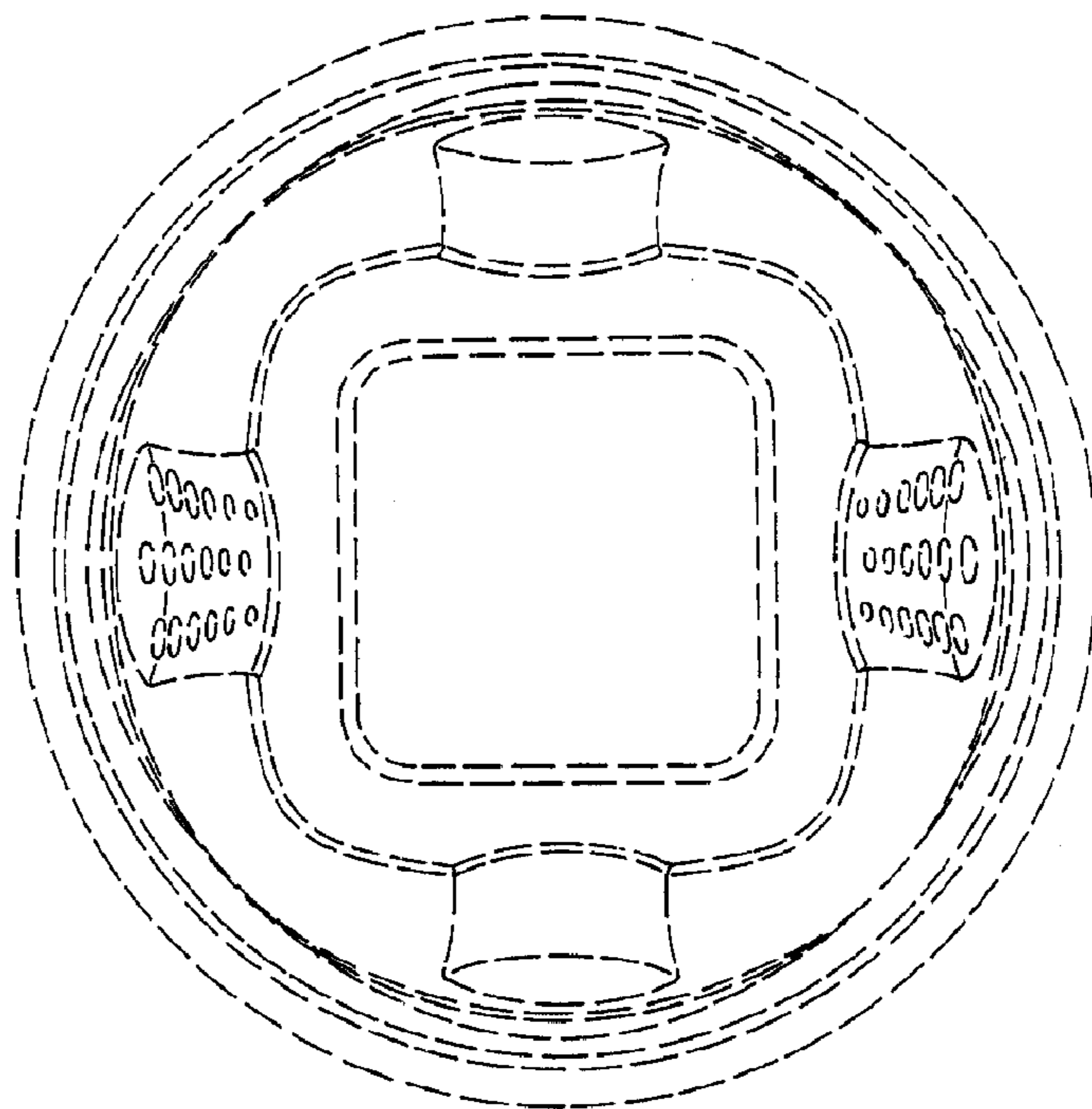
**FIG. 11**

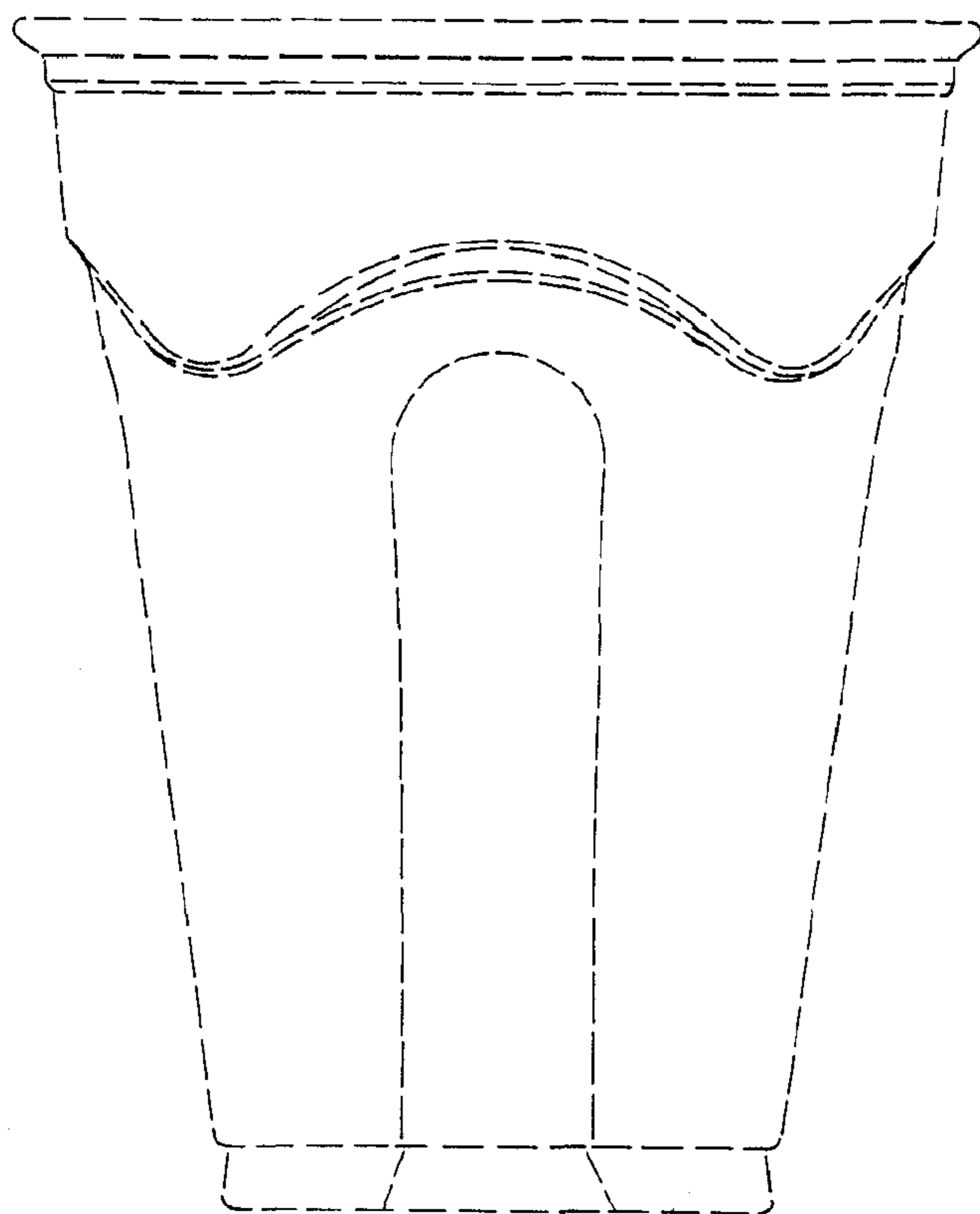




**FIG. 12**

**FIG. 13**





**FIG. 14**

**FIG. 15**

