



US00D627547S

(12) **United States Design Patent**  
**McClaskie**

(10) **Patent No.:** **US D627,547 S**

(45) **Date of Patent:** **\*\* Nov. 23, 2010**

(54) **SHOE**

(75) **Inventor:** **Thomas E. McClaskie**, Bethlehem, PA  
(US)

(73) **Assignee:** **Columbia Insurance Company**,  
Omaha, NE (US)

(\*\*) **Term:** **14 Years**

(21) **Appl. No.:** **29/360,280**

(22) **Filed:** **Apr. 22, 2010**

(51) **LOC (9) Cl.** ..... **02-04**

(52) **U.S. Cl.** ..... **D2/952; D2/951; D2/953**

(58) **Field of Classification Search** ..... D2/902,  
D2/906, 908, 916, 918, 925, 946, 947, 951-954,  
D2/956-962, 977; 36/3 B, 22 R, 24.5, 25 R,  
36/28, 32 R, 34 R, 59 C, 67 A, 103; D5/32,  
D5/37

See application file for complete search history.

(56) **References Cited**

**U.S. PATENT DOCUMENTS**

D84,816 S	8/1931	Freudenberg	
D144,330 S	4/1946	Walter	
D149,669 S	5/1948	Peister	
D168,540 S	1/1953	Friedman et al.	
D240,962 S	8/1976	Matsumoto	
D241,272 S *	8/1976	Matsumoto	D5/37
D265,690 S *	8/1982	Famolare, Jr.	D2/950
D495,856 S	9/2004	McClaskie	
D525,017 S	7/2006	Ochoa	
D585,634 S	2/2009	McClaskie	

D586,987 S *	2/2009	McClaskie	D2/952
D603,588 S *	11/2009	McClaskie	D2/950
D608,995 S *	2/2010	McClaskie	D5/16
D609,889 S *	2/2010	McClaskie	D2/952
D609,890 S *	2/2010	McClaskie	D2/952

\* cited by examiner

*Primary Examiner*—T. Chase Nelson

(74) *Attorney, Agent, or Firm*—St. Onge Steward Johnston & Reens LLC

(57) **CLAIM**

The ornamental design for a shoe, as shown and described.

**DESCRIPTION**

FIG. 1 is a bottom perspective view of a shoe in accordance with the new design;

FIG. 2 is a bottom view thereof;

FIG. 3 is a top view thereof;

FIG. 4 is a left side view thereof;

FIG. 5 is a right side view thereof;

FIG. 6 is a front view thereof; and,

FIG. 7 is a rear view thereof.

The shoe upper shown in broken lines in FIGS. 1-7 is for environmental purposes only and forms no part of the claimed design. The broken lines shown in each arch area of FIGS. 1 and 2 represent boundaries of the design with the lines themselves and the areas within them forming no part of the claimed design.

**1 Claim, 7 Drawing Sheets**

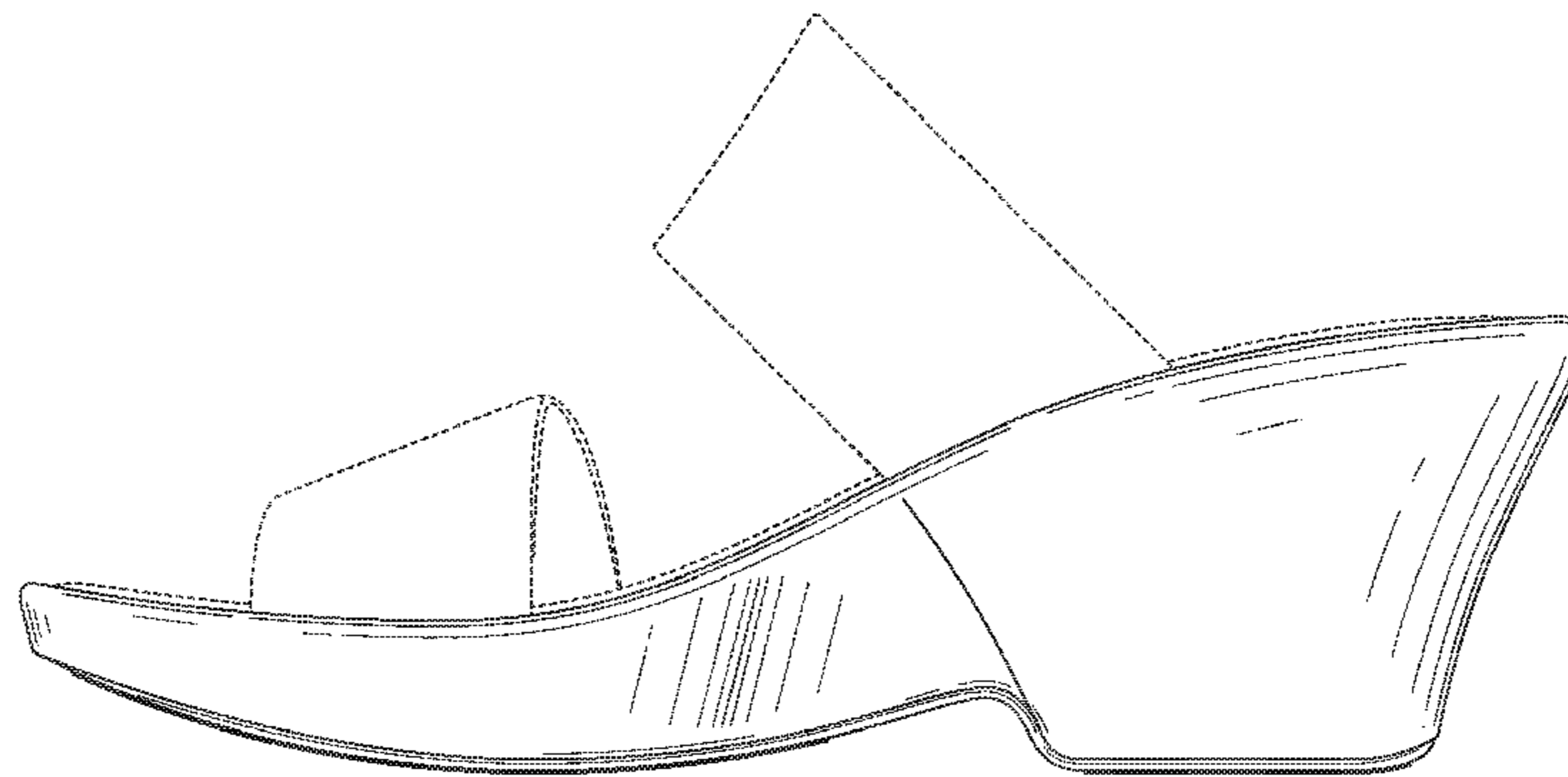
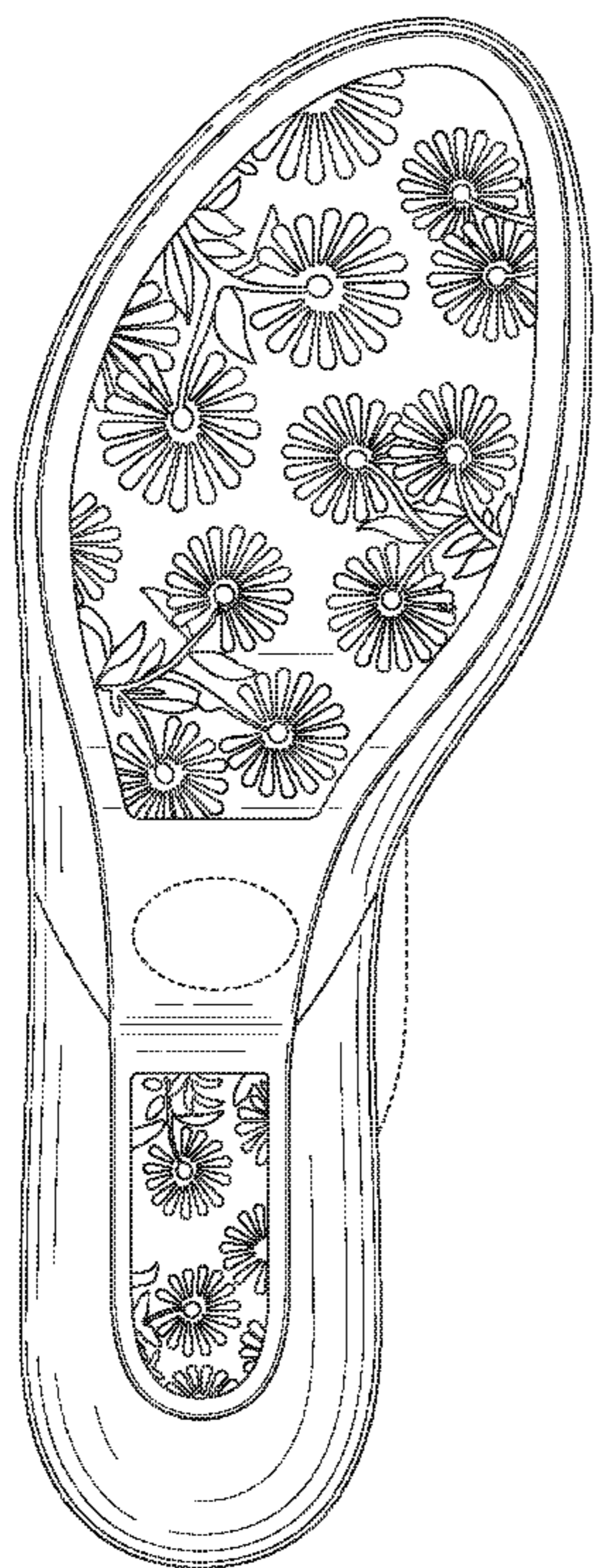

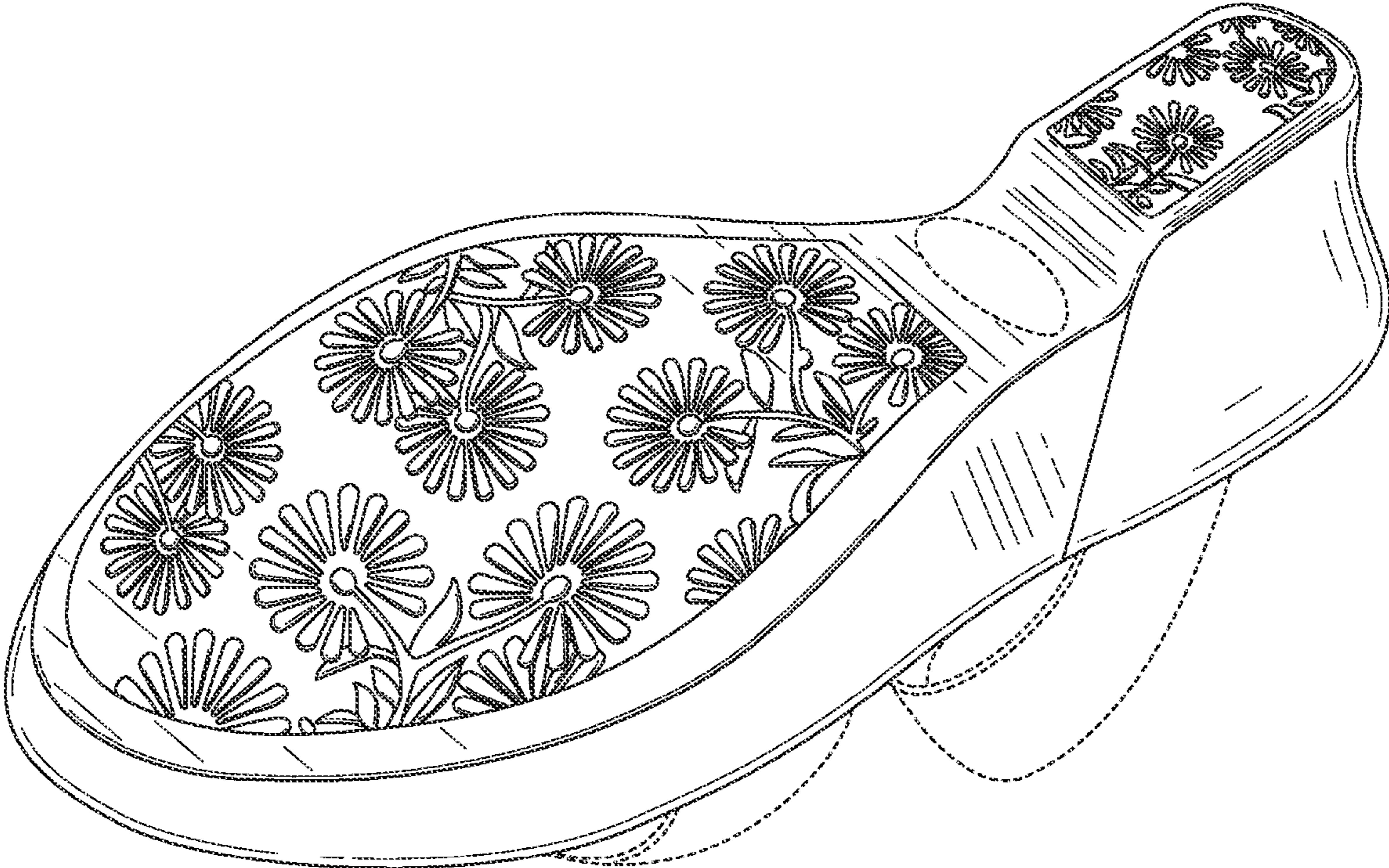

FIG. 1

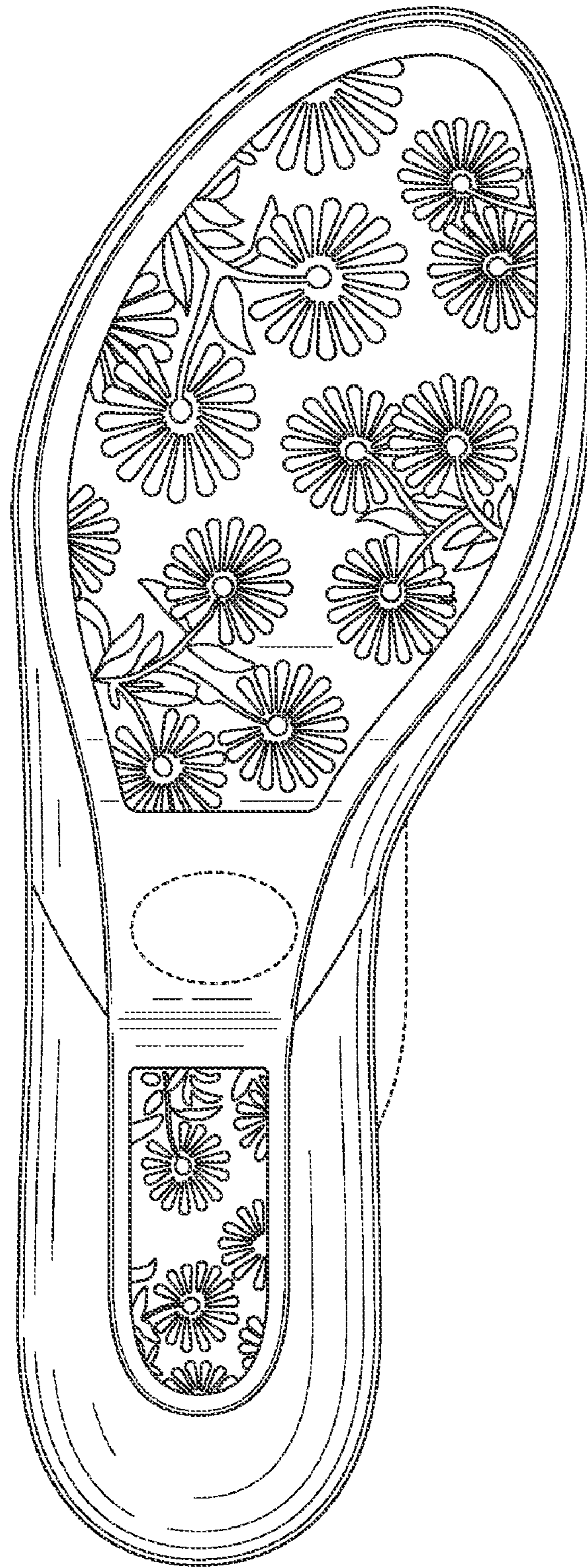

FIG. 2

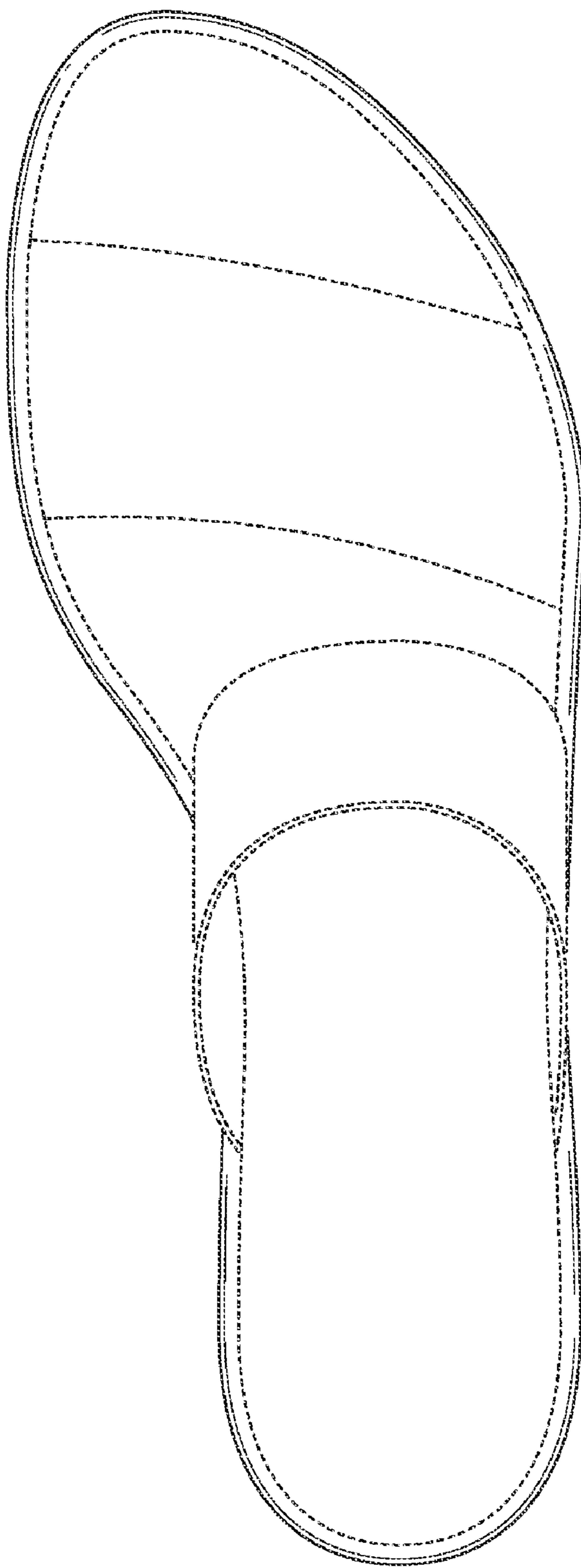

FIG. 3

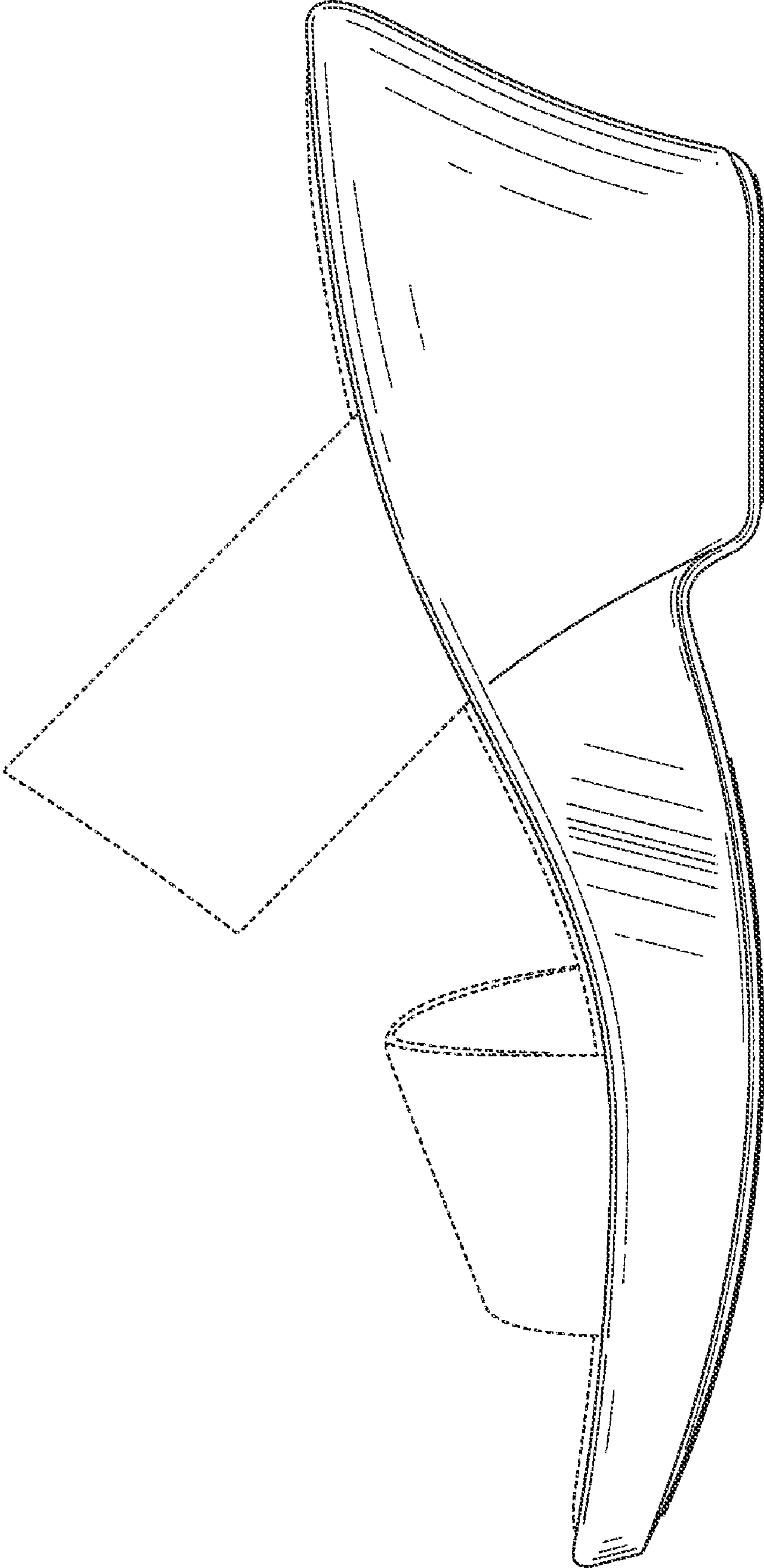

FIG. 4

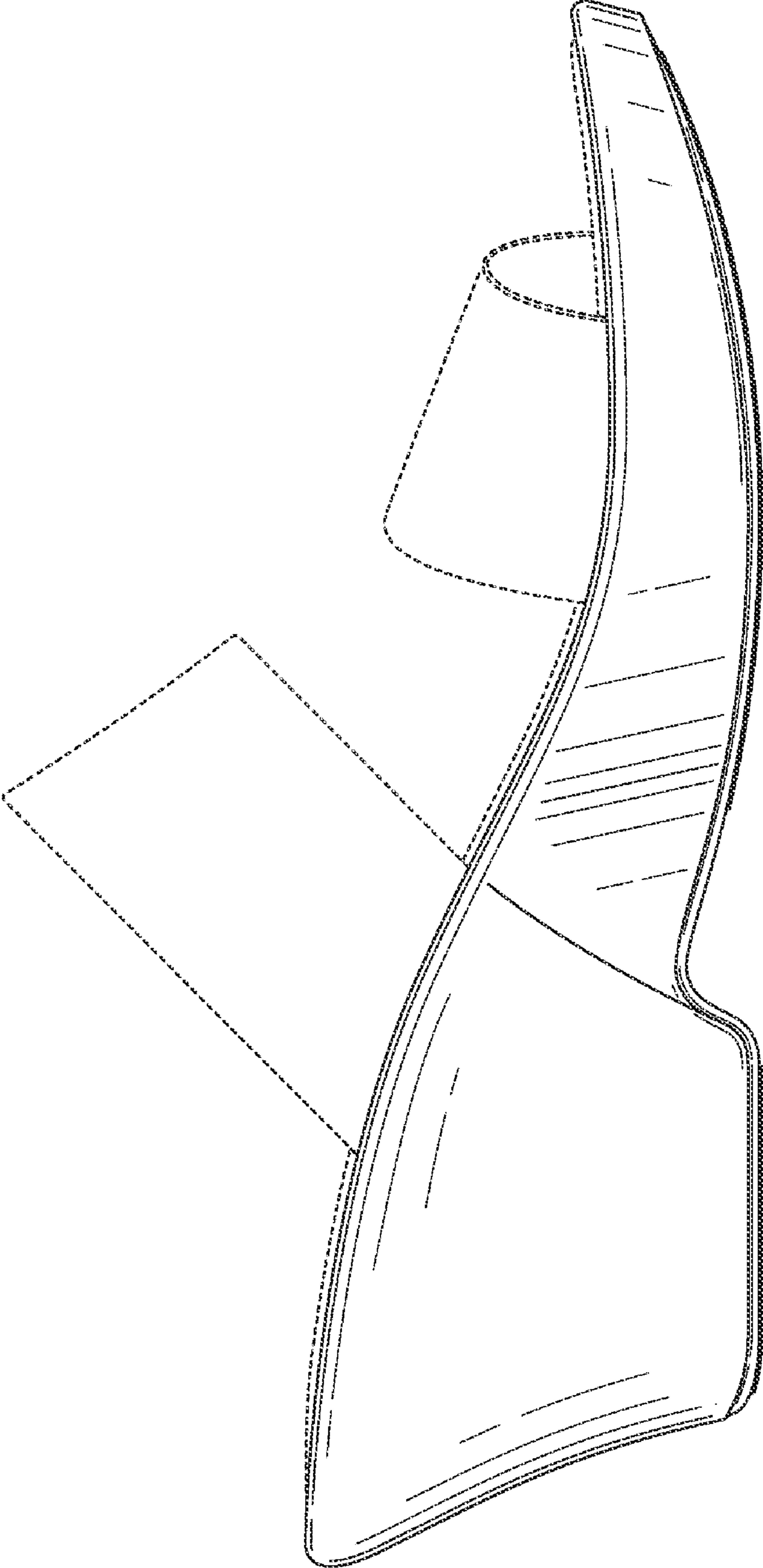

FIG. 5

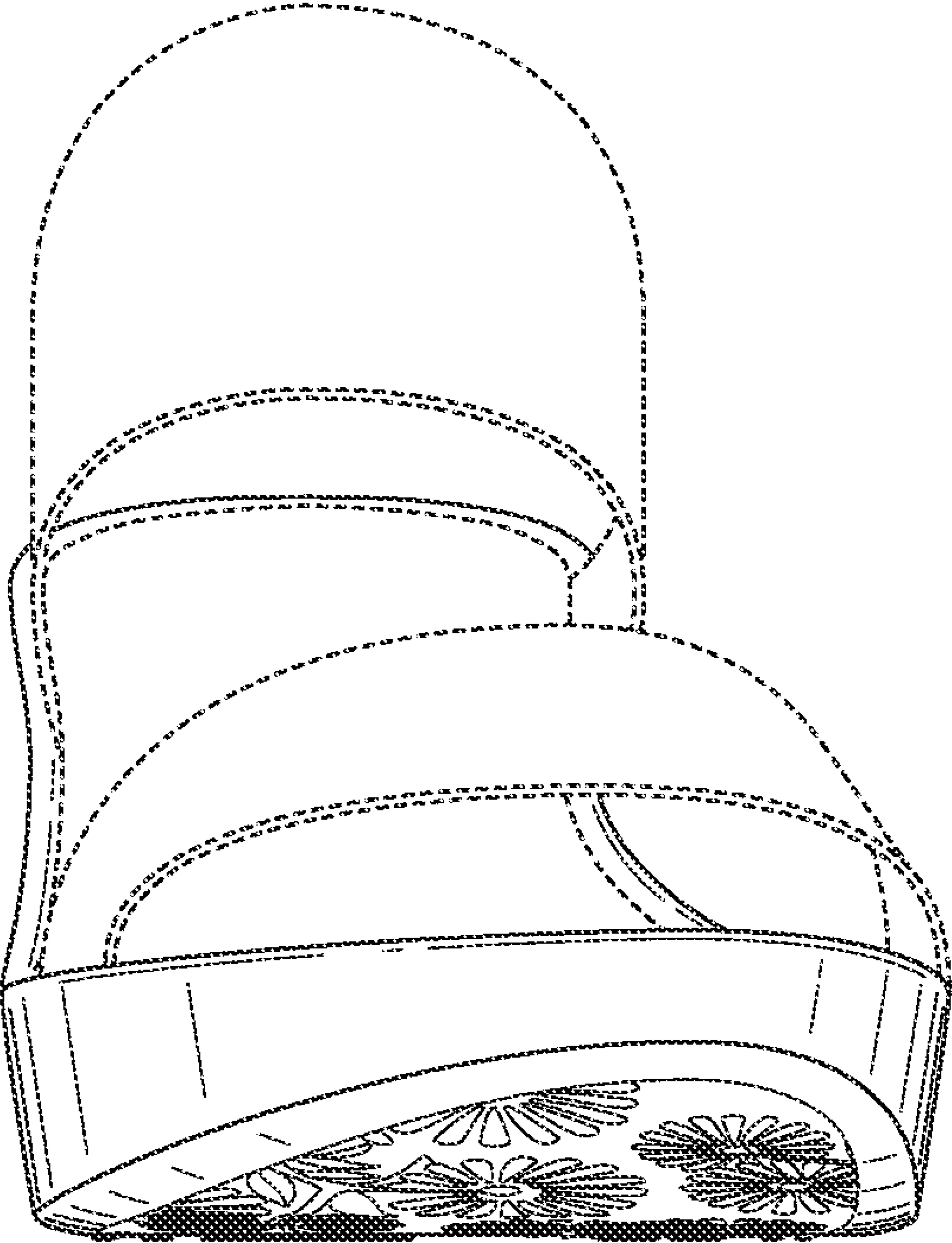

FIG. 6

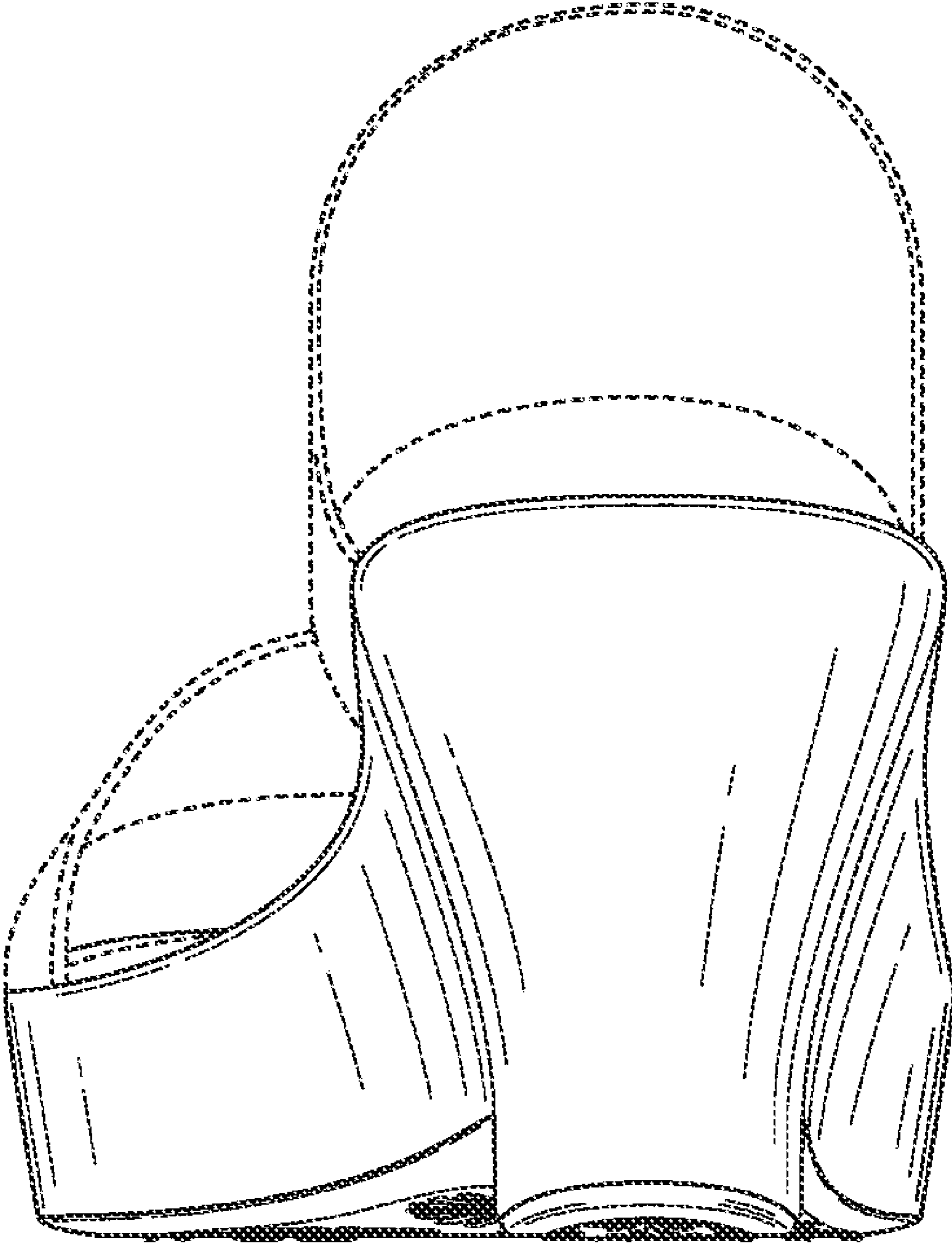

FIG. 7