



US00D627526S

(12) **United States Design Patent**
Hass

(10) **Patent No.:** **US D627,526 S**

(45) **Date of Patent:** **** Nov. 16, 2010**

(54) **PET TOY**

(75) Inventor: **Peter M. Hass**, Orinda, CA (US)

(73) Assignee: **Petsport USA, Inc.**, Pittsburg, CA (US)

(**) Term: **14 Years**

(21) Appl. No.: **29/344,661**

(22) Filed: **Oct. 1, 2009**

(51) **LOC (9) Cl.** **30-99**

(52) **U.S. Cl.** **D30/160; D21/601**

(58) **Field of Classification Search** D30/160;
D21/601, 622-623, 630; 119/702, 706-711
See application file for complete search history.

(56) **References Cited**

U.S. PATENT DOCUMENTS

D130,124 S *	10/1941	Hart	D21/400
D175,475 S *	8/1955	Oswald	D21/601
D228,077 S *	8/1973	MacKenzie	D21/623
D267,665 S *	1/1983	Robinson	D21/622
D332,290 S *	1/1993	Altiery	D21/601
D340,959 S *	11/1993	Warble	D21/622
D343,874 S *	2/1994	Messerli	D21/650
D356,354 S *	3/1995	Killion	D21/436
D423,152 S *	4/2000	Kelly	D30/160
D452,593 S *	12/2001	Kaplan	D30/160
D493,260 S *	7/2004	Oblack	D30/160
D523,190 S *	6/2006	Oblack	D30/160
D537,813 S *	3/2007	Hoehn et al.	D21/630
7,207,294 B2 *	4/2007	Stasio	119/707
D554,714 S *	11/2007	Chow	D21/601

7,722,428 B2 * 5/2010 Di Lullo 119/707

* cited by examiner

Primary Examiner—Cathy Anne MacCormac

(74) *Attorney, Agent, or Firm*—Holland & Knight LLP;
Richard E. Lyon, Jr.

(57) **CLAIM**

The ornamental design for a pet toy, as shown and described.

DESCRIPTION

FIG. 1 is a perspective view of a first embodiment of the pet toy of my design;

FIG. 2 is a front view thereof;

FIG. 3 is a top plan view thereof;

FIG. 4 is a right side view thereof;

FIG. 5 is a left side view thereof;

FIG. 6 is a rear view thereof;

FIG. 7 is a bottom view thereof;

FIG. 8 is a perspective view of a second embodiment of the pet toy of my design;

FIG. 9 is a front view of the second embodiment of the pet toy of my design;

FIG. 10 is a top plan view of the second embodiment of the pet toy of my design;

FIG. 11 is a right side view of the second embodiment of the pet toy of my design; and,

FIG. 12 is a left side view of the second embodiment of the pet toy of my design; the rear and bottom views of the second embodiment of the pet toy of my design are the same as those shown in FIGS. 6 and 7 respectively.

1 Claim, 7 Drawing Sheets

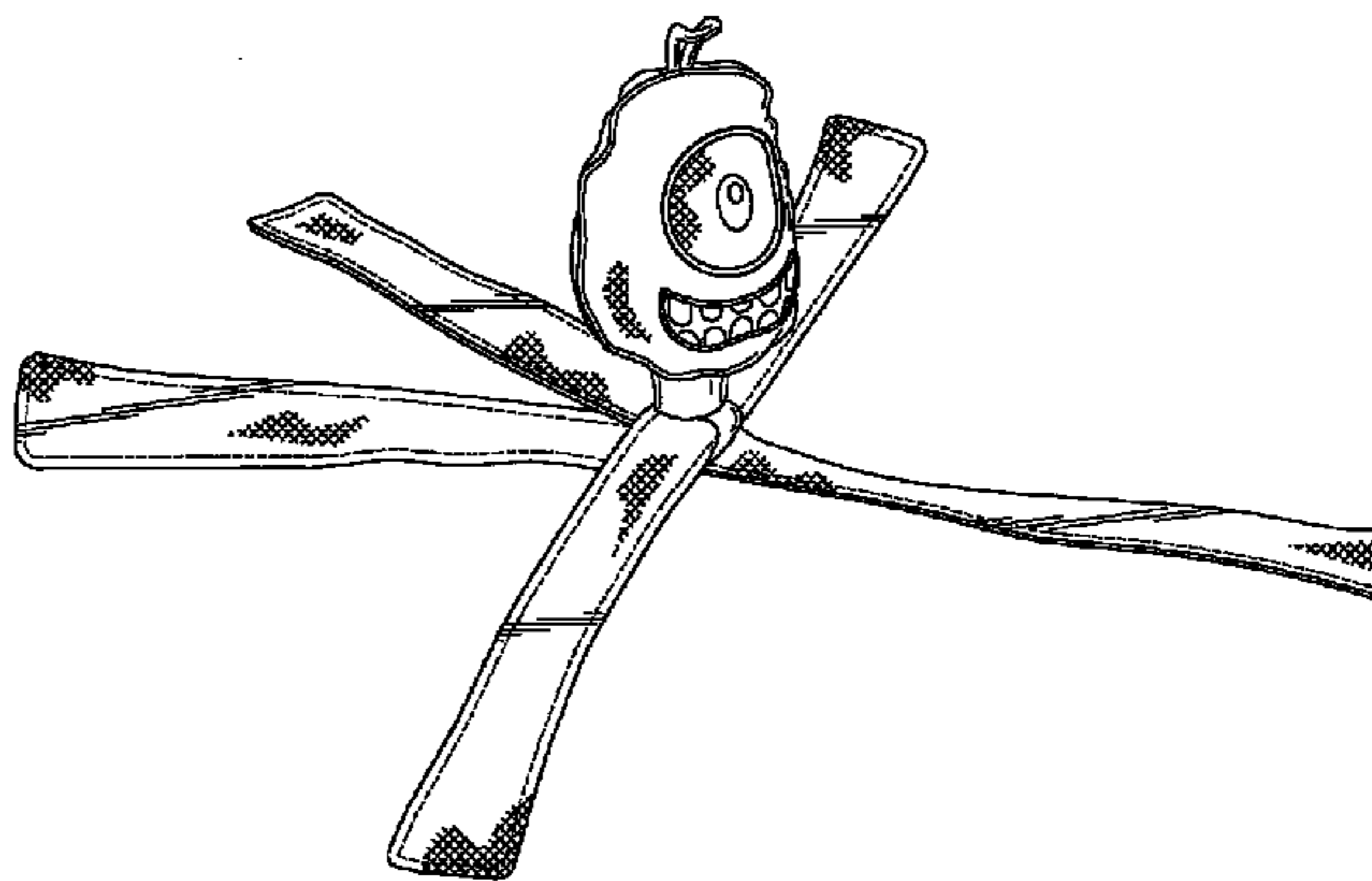
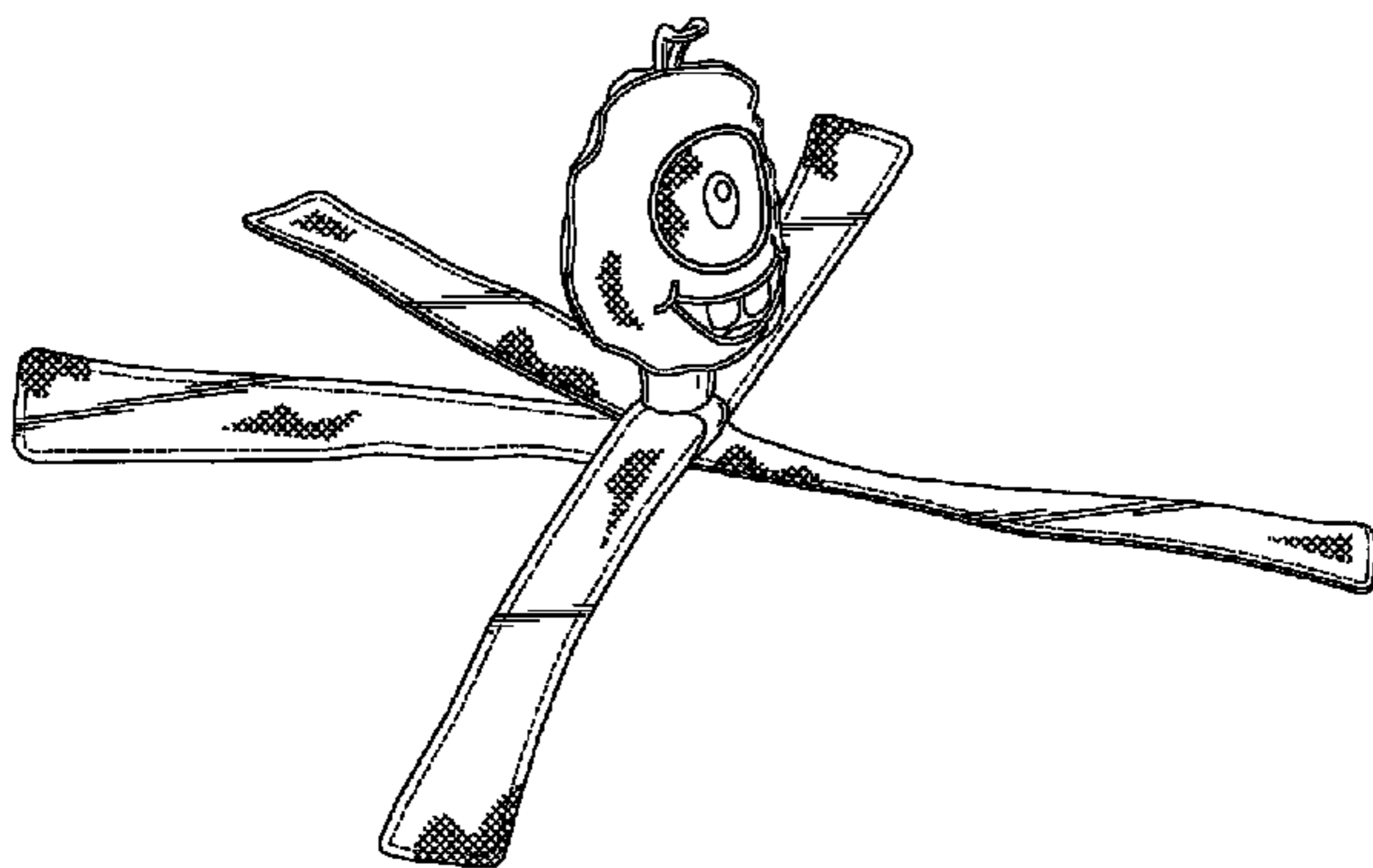

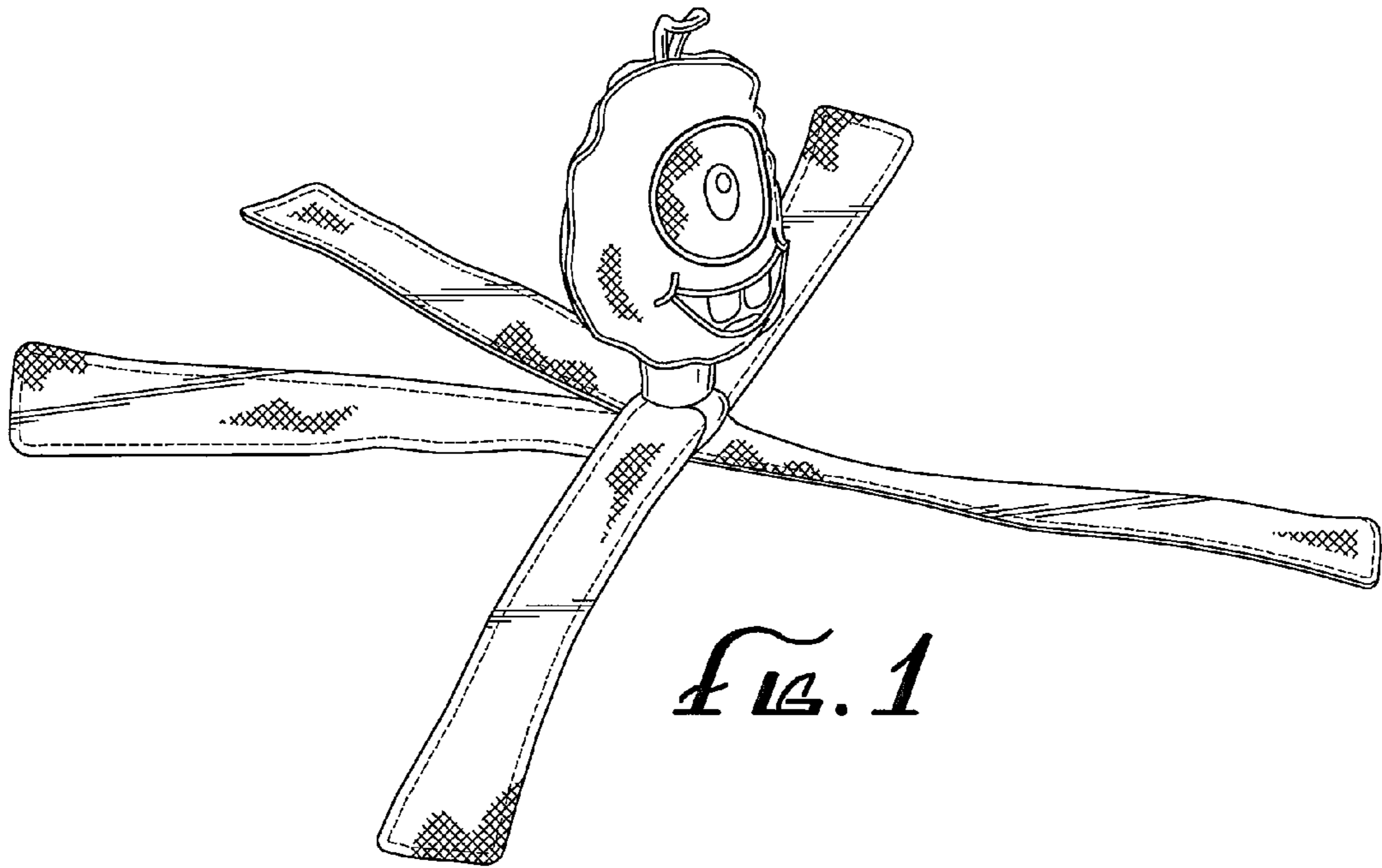

FIG. 1

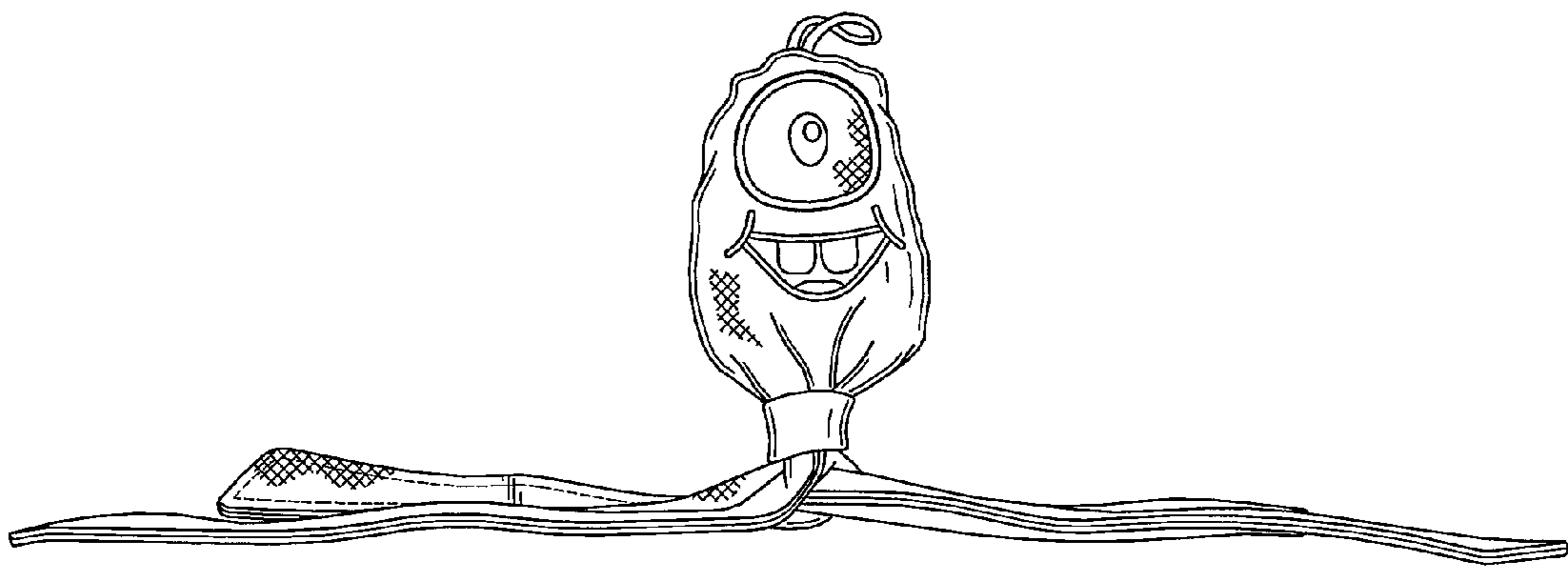
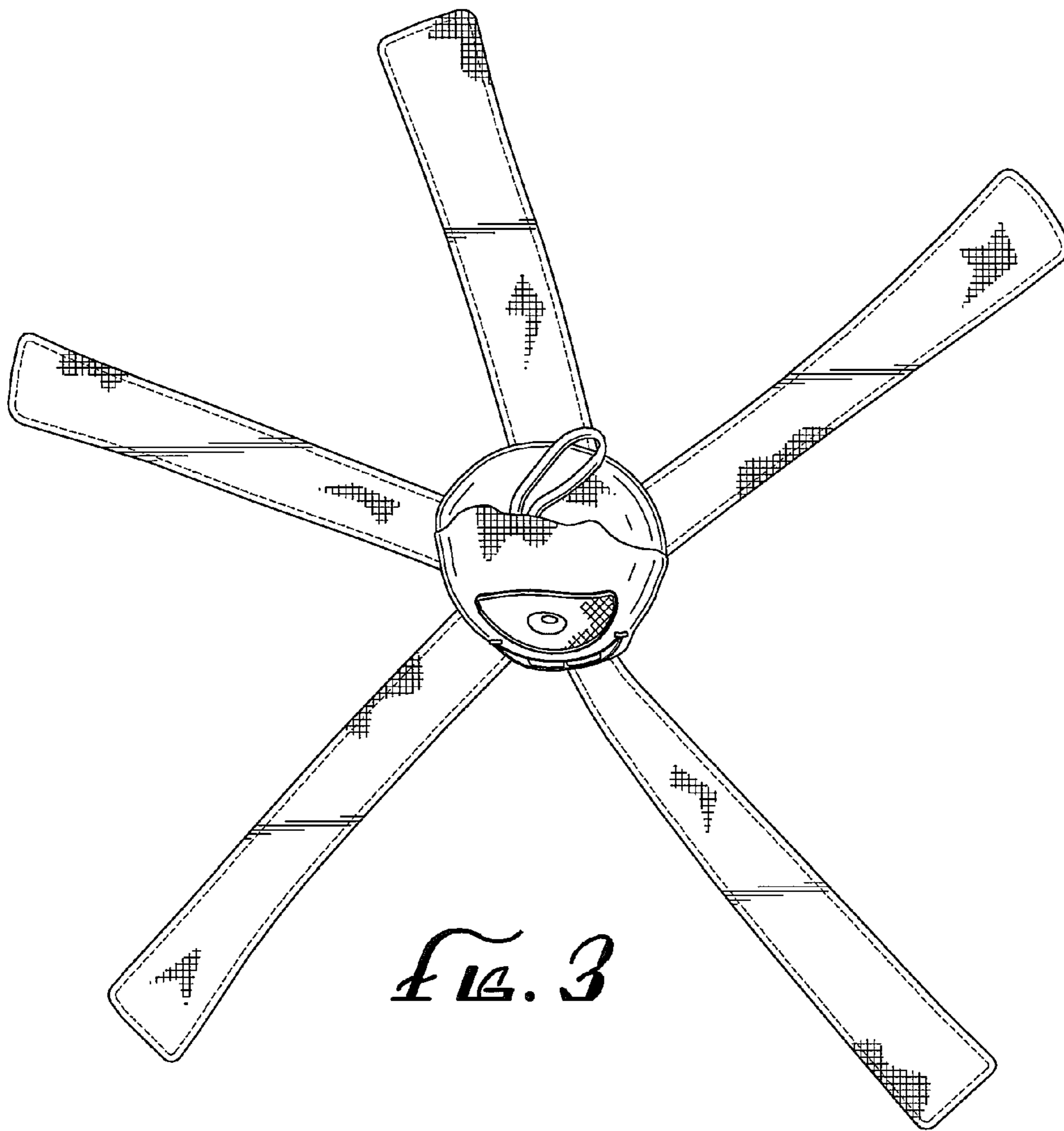

FIG. 2



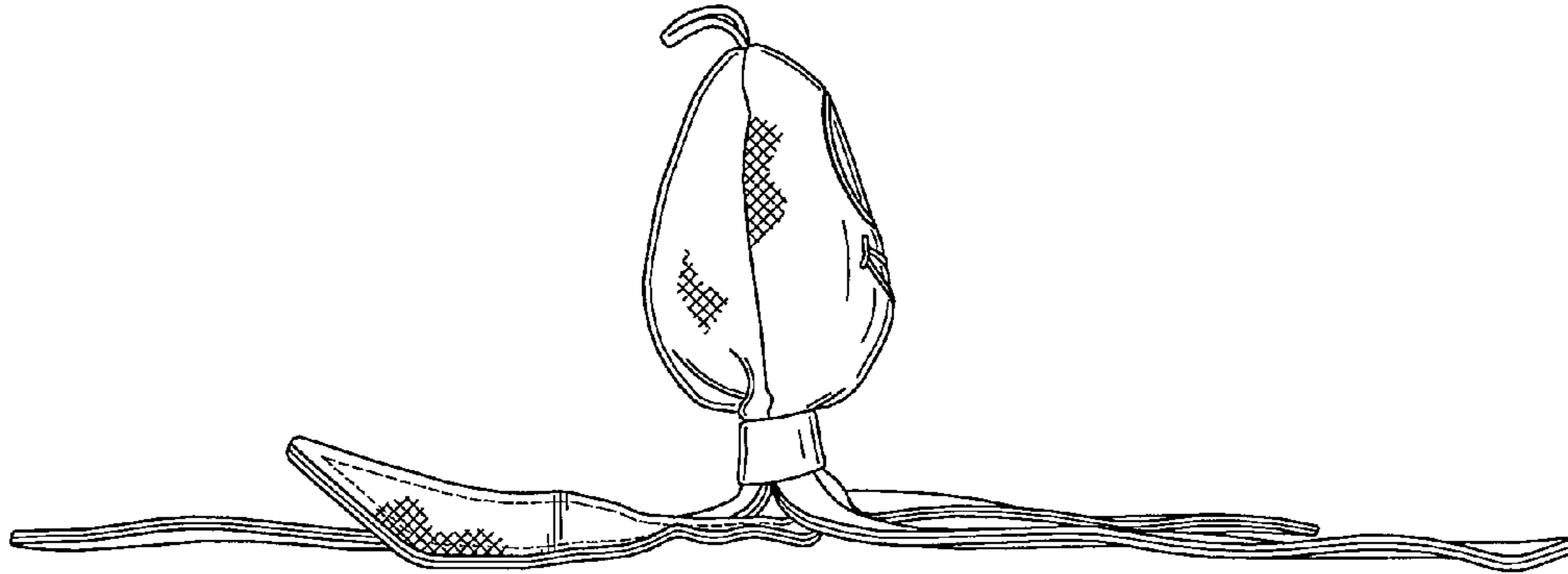

FIG. 4

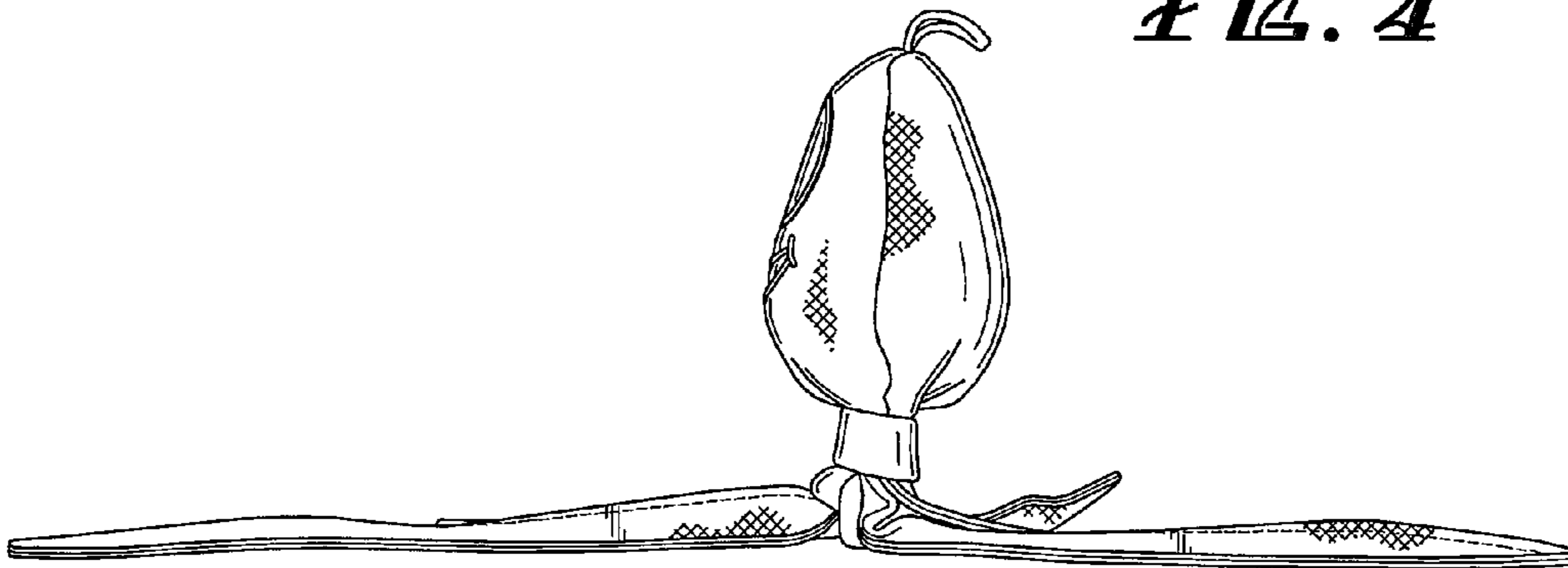

FIG. 5

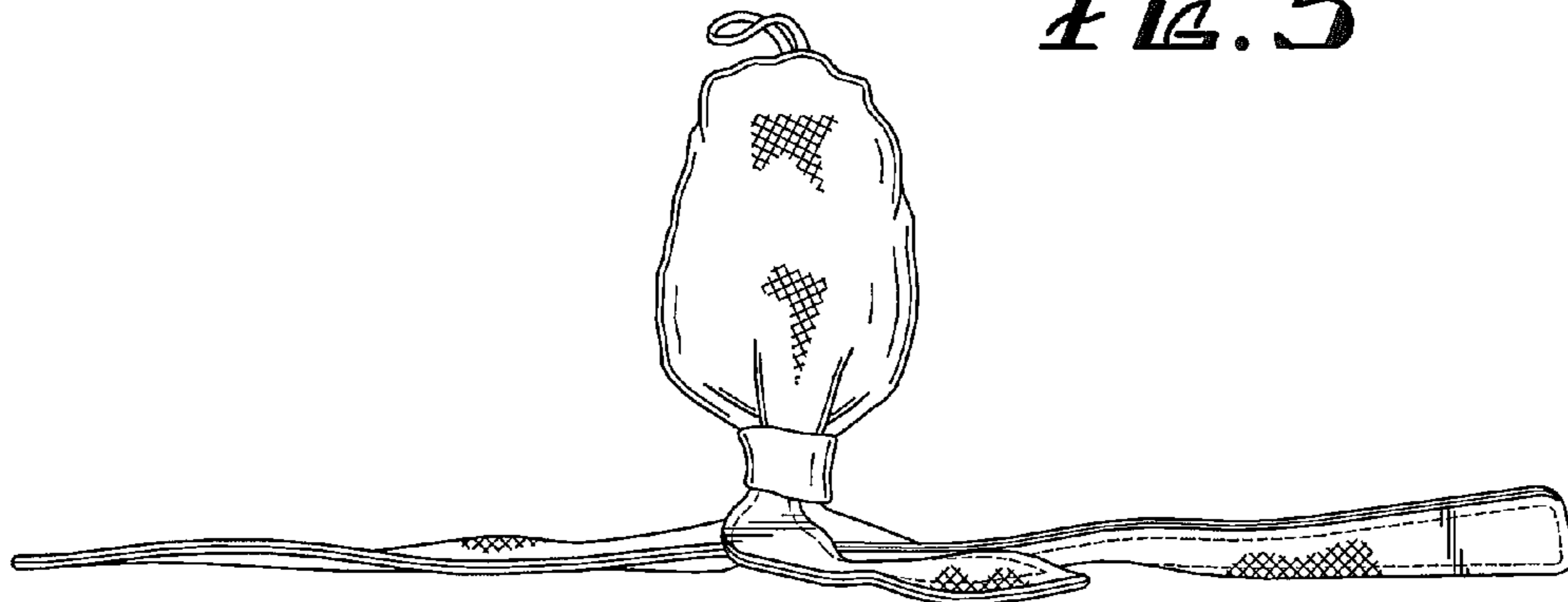
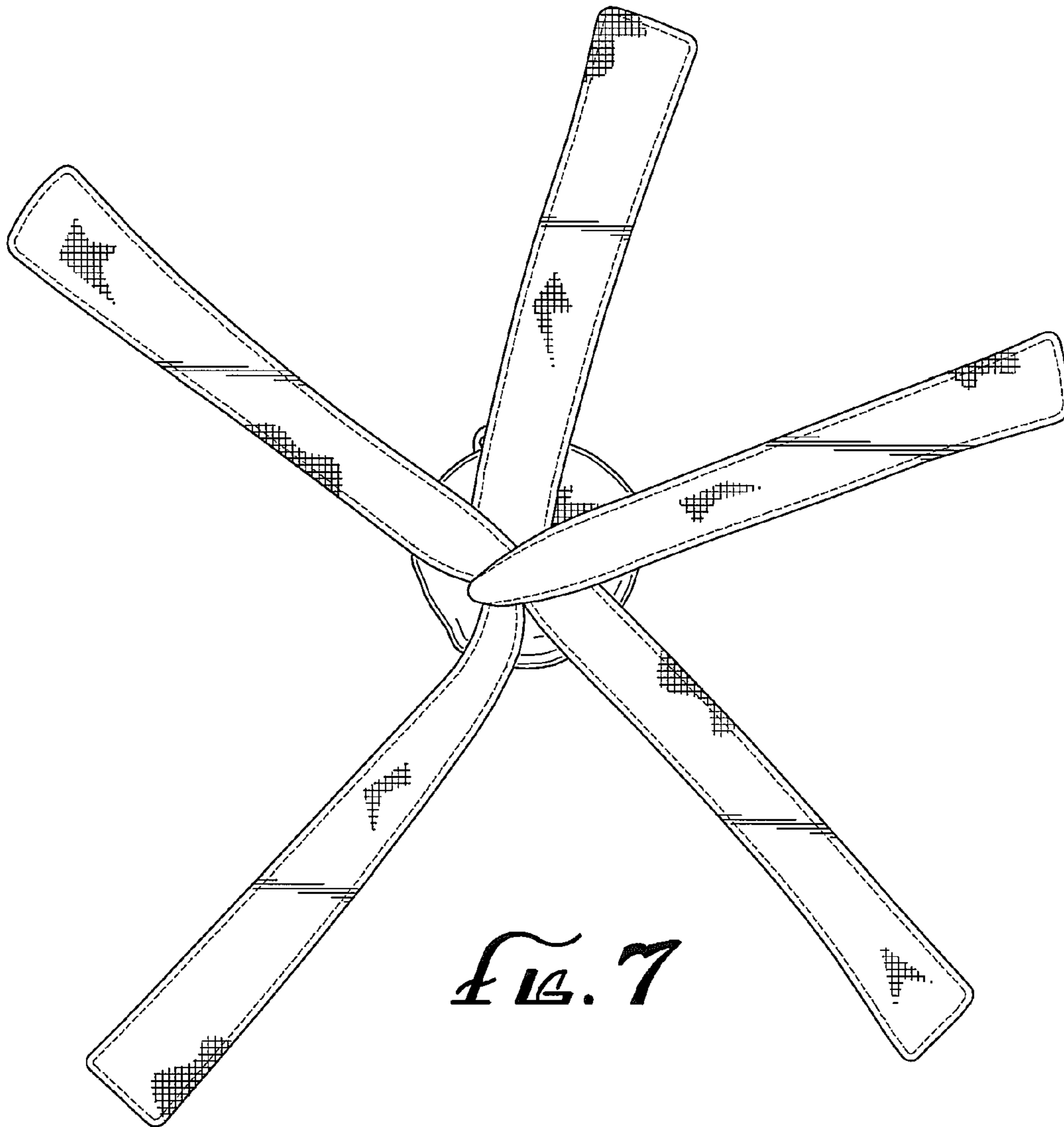

FIG. 6



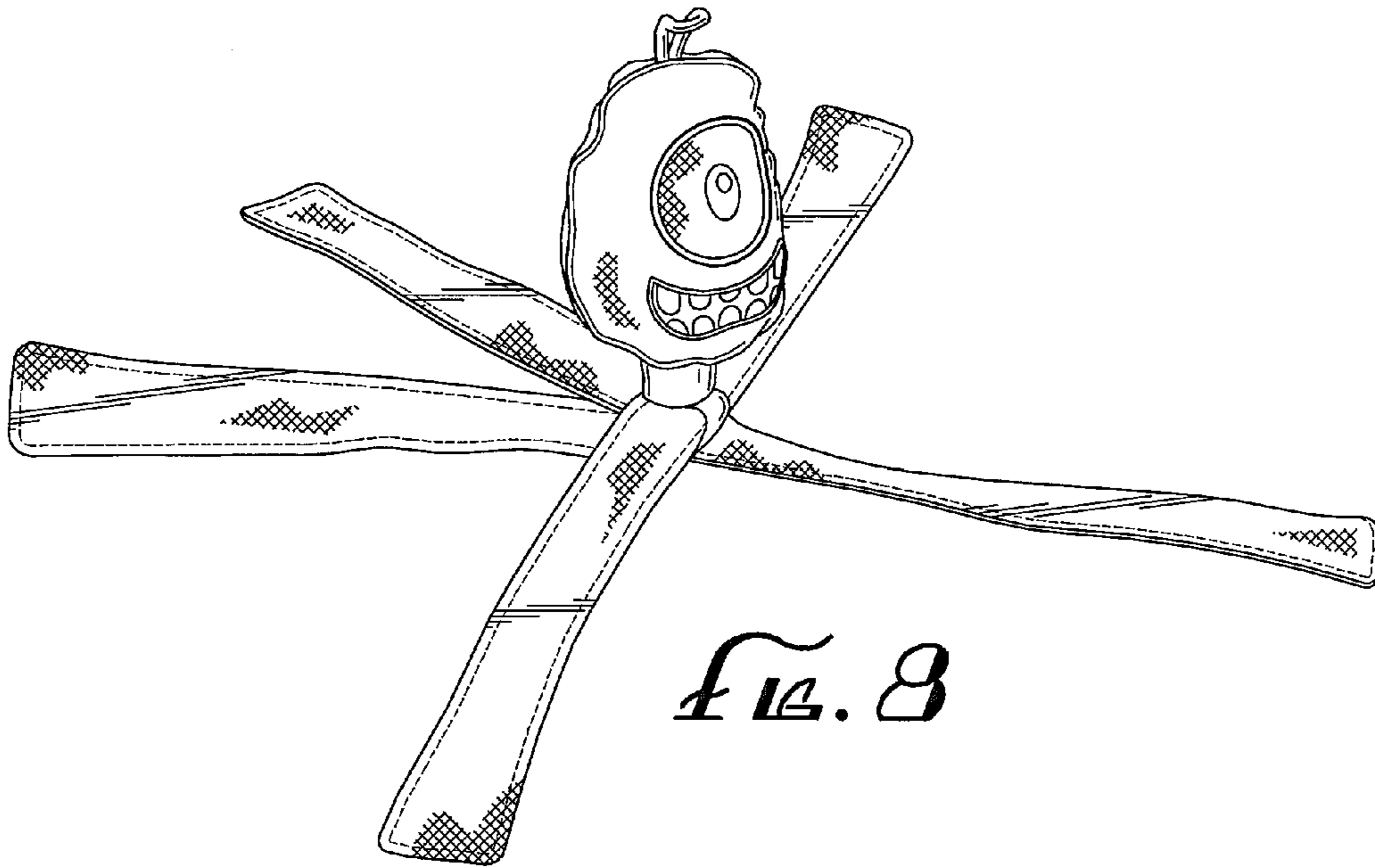

FIG. 8

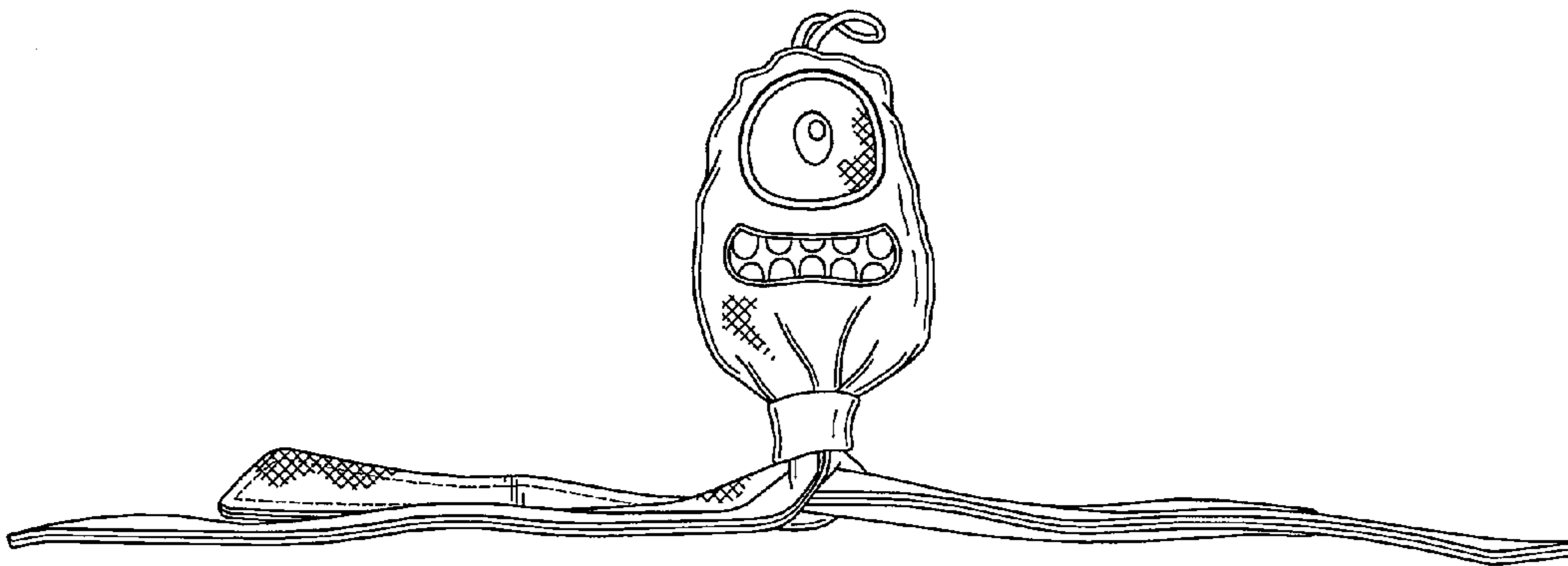
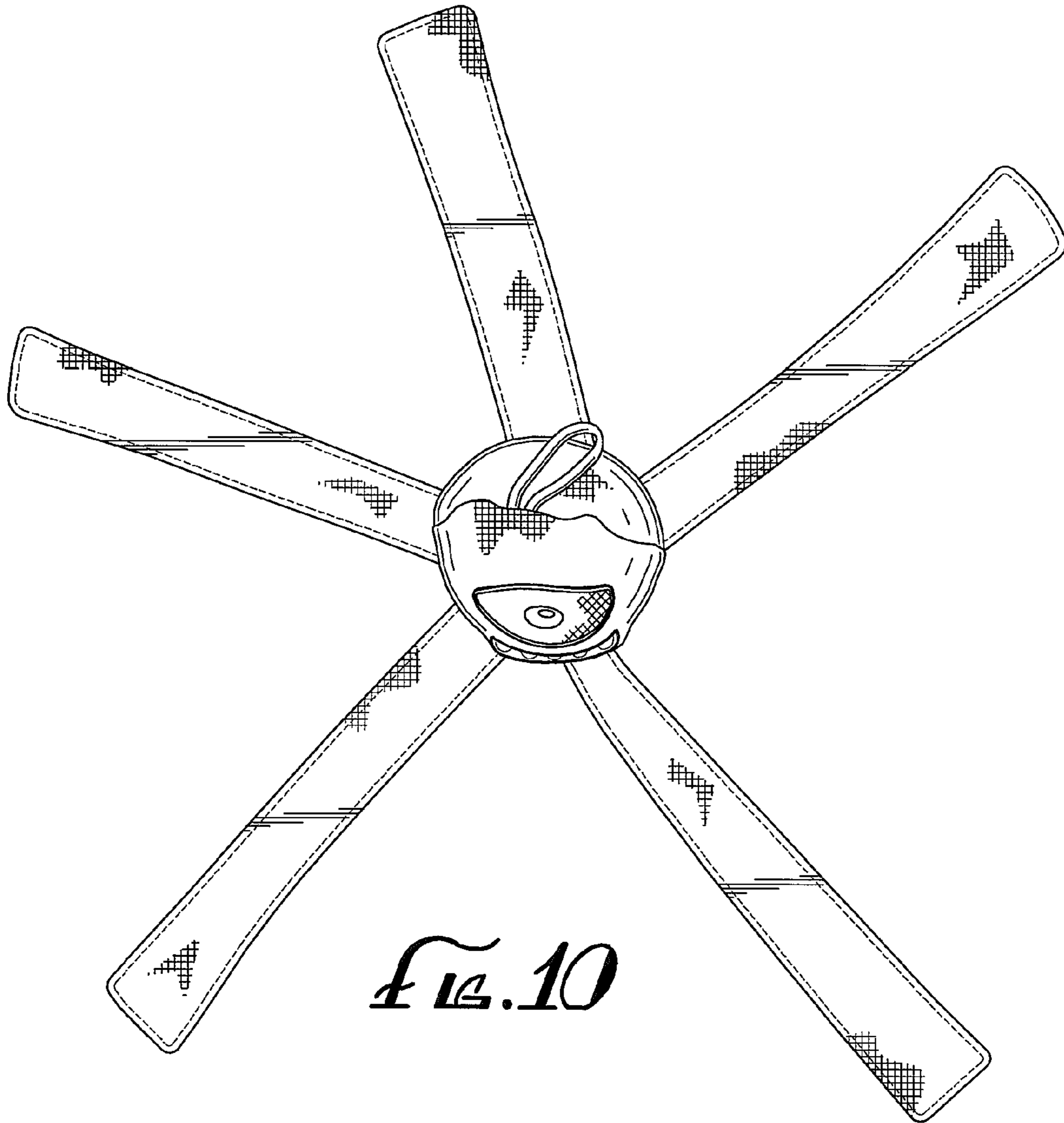

FIG. 9



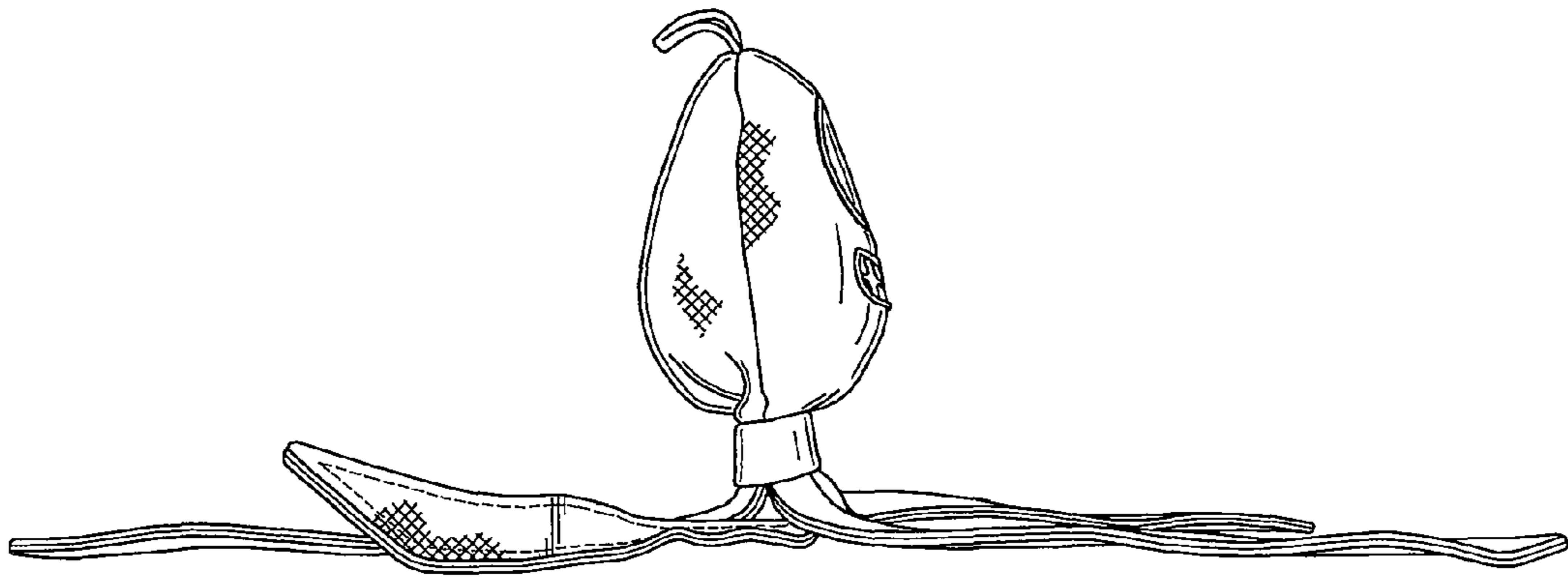

FIG. 11

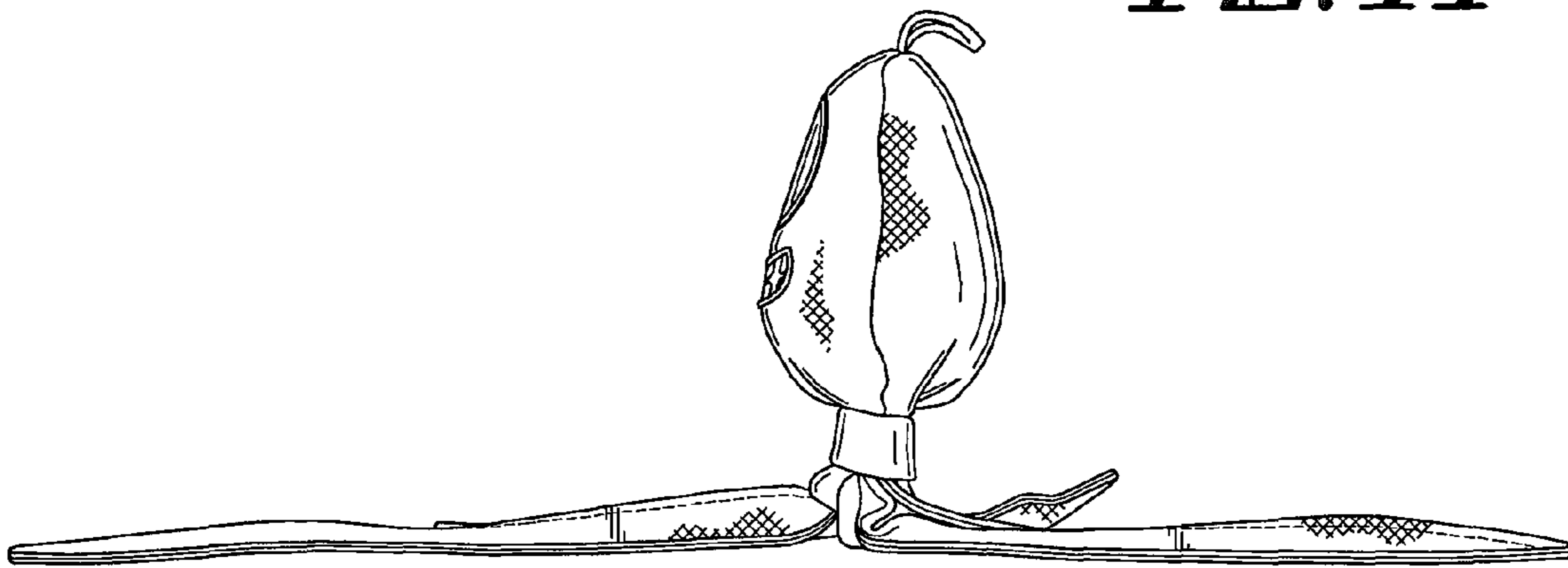

FIG. 12