

US00D627519S

(12) **United States Design Patent**
DeMarco

(10) **Patent No.:** **US D627,519 S**

(45) **Date of Patent:** **** Nov. 16, 2010**

(54) **COSMETIC CONTAINER**

(75) Inventor: **Jenny DeMarco**, Plano, TX (US)

(73) Assignee: **Mary Kay Inc.**, Dallas, TX (US)

(**) Term: **14 Years**

(21) Appl. No.: **29/338,764**

(22) Filed: **Jun. 18, 2009**

(51) **LOC (9) Cl.** **28-03**

(52) **U.S. Cl.** **D28/83**

(58) **Field of Classification Search** D28/76-84;
D9/500, 503-505, 414, 418, 420-423, 428;
206/581, 823; 132/286-318

See application file for complete search history.

(56) **References Cited**

U.S. PATENT DOCUMENTS

D301,124 S	5/1989	Bakic	D28/83
D301,642 S	6/1989	Bakic	D28/83
D302,602 S	8/1989	Bakic	D28/78
D302,604 S	8/1989	Bakic	D28/83
D302,745 S	8/1989	Bakic	D28/83
D302,872 S	8/1989	Bakic	D28/78
D303,163 S	8/1989	Bakic	D28/78
4,863,034 A	9/1989	Contreras, Sr.	206/581
D304,098 S	10/1989	Desgrippes	D28/78
D305,164 S	12/1989	Hall	D28/83
D305,281 S *	1/1990	Chen	D28/76
D305,947 S	2/1990	Chevassus	D28/78
4,917,131 A	4/1990	Contreras, Sr.	132/301
4,930,528 A	6/1990	Hatakeyama	132/301
D309,043 S	7/1990	Bakic	D28/78
D309,358 S	7/1990	Machelett et al.	D28/78
D309,511 S	7/1990	Bertlin et al.	D28/78
4,972,860 A	11/1990	Yuhara et al.	132/301
D313,288 S	12/1990	Bakic	D28/77
D314,066 S	1/1991	Bakic	D28/82
4,982,751 A	1/1991	Oishi et al.	132/299
4,989,622 A	2/1991	Kozuka et al.	132/301
5,022,529 A *	6/1991	Kang	206/581
D318,144 S	7/1991	Scarpa et al.	D28/78
D319,897 S *	9/1991	Bakic	D28/82

D322,692 S	12/1991	Trabattoni	D28/83
5,078,159 A	1/1992	Yuhara	132/295
D324,587 S	3/1992	Di Nuccio	D28/78
5,107,871 A	4/1992	Butcher et al.	132/304
5,135,012 A	8/1992	Kamen et al.	132/294
D338,086 S	8/1993	Roberts	D28/78
D338,279 S	8/1993	Davis	D28/83
D342,346 S	12/1993	Fiocco	D28/78
D343,925 S	2/1994	Garouste et al.	D28/78
5,320,116 A	6/1994	Ackermann	132/293
5,323,794 A	6/1994	Favre	132/294
D351,682 S	10/1994	McIlvain	D28/78
D355,730 S	2/1995	Chen	D28/78
D359,819 S	6/1995	McIlvain et al.	D28/78
5,431,176 A	7/1995	Favre	132/295
5,431,177 A	7/1995	Kecman	132/303
D364,709 S	11/1995	Gavin	D28/78
5,605,167 A	2/1997	Montoli	132/294

(Continued)

Primary Examiner—Jennifer Rivard

(74) *Attorney, Agent, or Firm*—Fulbright & Jaworski L.L.P.

(57)

CLAIM

The ornamental design for a cosmetic container, as shown and described.

DESCRIPTION

FIG. 1 is a top perspective view of my design in a closed position;

FIG. 2 is a front view thereof;

FIG. 3 is a back view thereof;

FIG. 4 is a top view thereof;

FIG. 5 is a left side view thereof;

FIG. 6 is a right side view thereof; and,

FIG. 7 is a bottom view thereof.

All other surface(s) or portion(s) of the embodiments of my design not shown in the figures or otherwise described in the specification form no part of the claimed design.

1 Claim, 3 Drawing Sheets

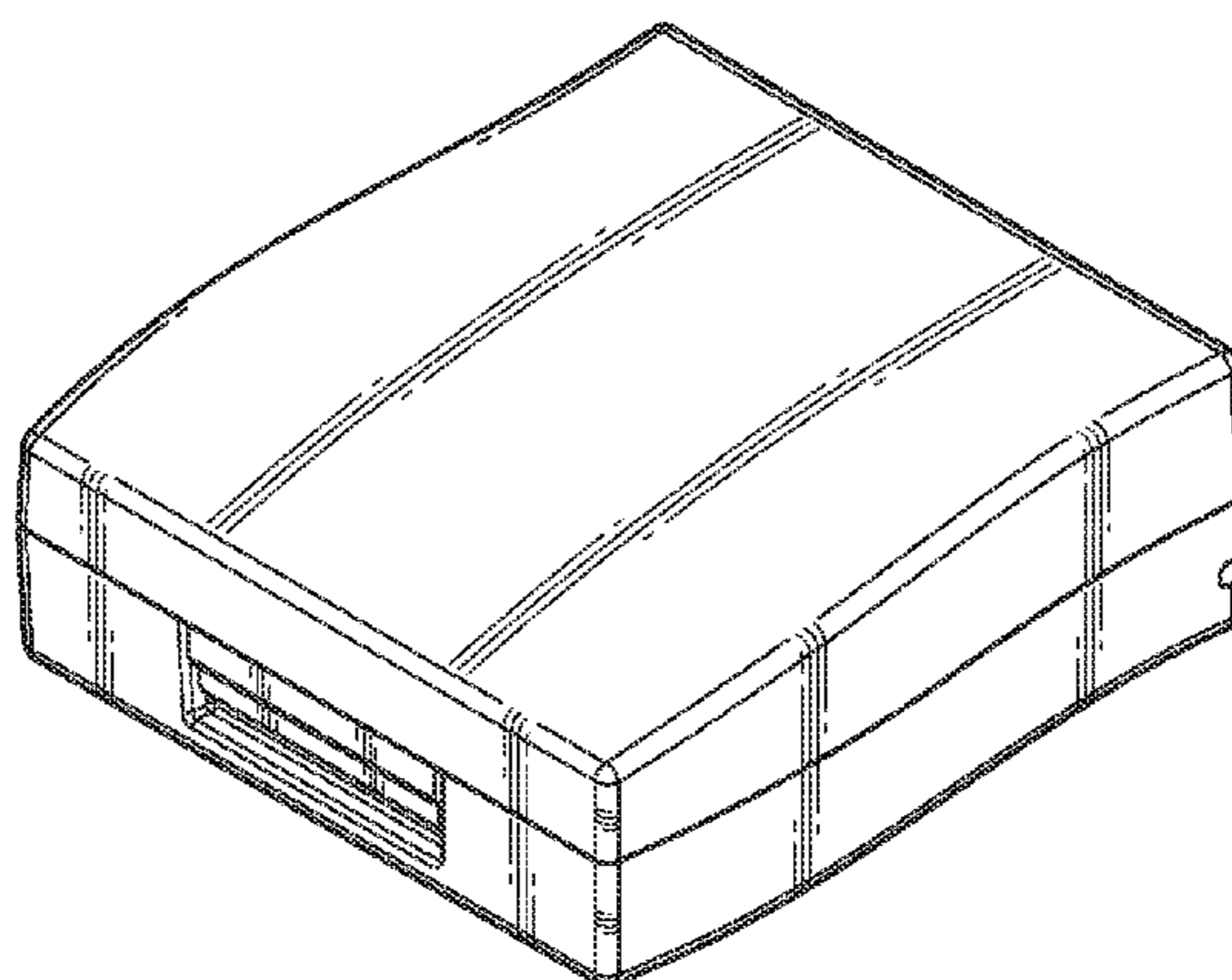

US D627,519 S

Page 2

U.S. PATENT DOCUMENTS

5,769,234 A	6/1998	Gueret	206/581	D518,603 S	4/2006	Dittmer et al.	D28/83
D404,532 S	1/1999	Castagna	D28/77	D523,177 S	6/2006	Ashiwa et al.	D28/82
D407,855 S	4/1999	Orsomando	D28/83	D530,861 S	10/2006	Kuo	D28/83
D412,602 S	8/1999	Bakic	D28/83	D542,475 S	5/2007	Martinez	D28/83
6,199,559 B1	3/2001	Nikolaus et al.	132/294	D554,292 S	10/2007	Thorpe	D28/82
6,223,754 B1	5/2001	Burdi et al.	132/300	7,275,642 B2	10/2007	Yuhara	206/581
6,283,129 B1	9/2001	Yuhara et al.	132/295	D561,944 S	2/2008	Ashiwa et al.	D28/83
D452,939 S	1/2002	Lai	D28/77	D564,133 S	3/2008	Boyé et al.	D28/83
D453,859 S	2/2002	Spearman	D28/77	7,464,820 B2	12/2008	Oh	206/581
D455,235 S	4/2002	Braaten et al.	D28/78	7,469,787 B2	12/2008	Yuhara	206/581
D457,687 S	5/2002	Millar	D28/83	D601,757 S *	10/2009	Sagel	D28/83
D462,809 S	9/2002	LaSpina et al.	D28/78	D611,657 S *	3/2010	Maddy et al.	D28/83
D463,884 S	10/2002	Fang	D28/82	2002/0162566 A1	11/2002	Jang	132/294
D465,035 S	10/2002	McFarland	D25/122	2002/0162567 A1	11/2002	Jang	132/294
6,536,447 B1	3/2003	Fioravanti et al.	132/299	2004/0003825 A1	1/2004	Kelly	132/301
D473,680 S	4/2003	Saunders et al.	D28/78	2004/0129599 A1	7/2004	Yi-Hung	206/581
D478,396 S	8/2003	Bakic	D28/78	2004/0200755 A1	10/2004	Gueret	206/581
D478,397 S	8/2003	Bakic	D28/83	2004/0244812 A1	12/2004	Seidler et al.	132/301
D478,689 S	8/2003	Thorpe	D28/83	2005/0023183 A1	2/2005	Banik et al.	220/837
D479,016 S	8/2003	Sgariboldi	D28/78	2005/0178694 A1	8/2005	Mecca et al.	220/835
6,712,076 B2	3/2004	Alexander et al.	132/293	2006/0015355 A1	1/2006	Wolkoff et al.	705/14
6,769,438 B2	8/2004	Fraillon	132/304	2006/0226164 A1	10/2006	Graham	206/69
D496,133 S	9/2004	Dittmer et al.	D28/83	2007/0017848 A1	1/2007	Sasaki	206/581
D496,759 S	9/2004	Rodriguez	D28/82	2007/0080094 A1	4/2007	Moon	220/817
D503,245 S	3/2005	Vanoncini	D28/78	2007/0108093 A1	5/2007	Park et al.	200/288
D503,616 S *	4/2005	Ghini et al.	D9/430	2007/0121315 A1	5/2007	Lan	362/135
D503,831 S	4/2005	Ames	D28/78	2008/0000493 A1	1/2008	Anderson et al.	132/295
D504,743 S	5/2005	Kostow	D28/78	2008/0023023 A1	1/2008	Boye et al.	132/294
6,901,937 B2	6/2005	Sebban	132/301	2008/0099038 A1	5/2008	Washington	132/300
D513,978 S *	1/2006	Isono et al.	D9/424	2008/0289645 A1	11/2008	Guillot	132/200
D517,244 S	3/2006	Ditrichstein et al.	D28/78	2009/0071867 A1	3/2009	Au	312/283
D517,245 S	3/2006	Ditrichstein et al.	D28/83	2009/0078279 A1	3/2009	Boye et al.	132/294

* cited by examiner

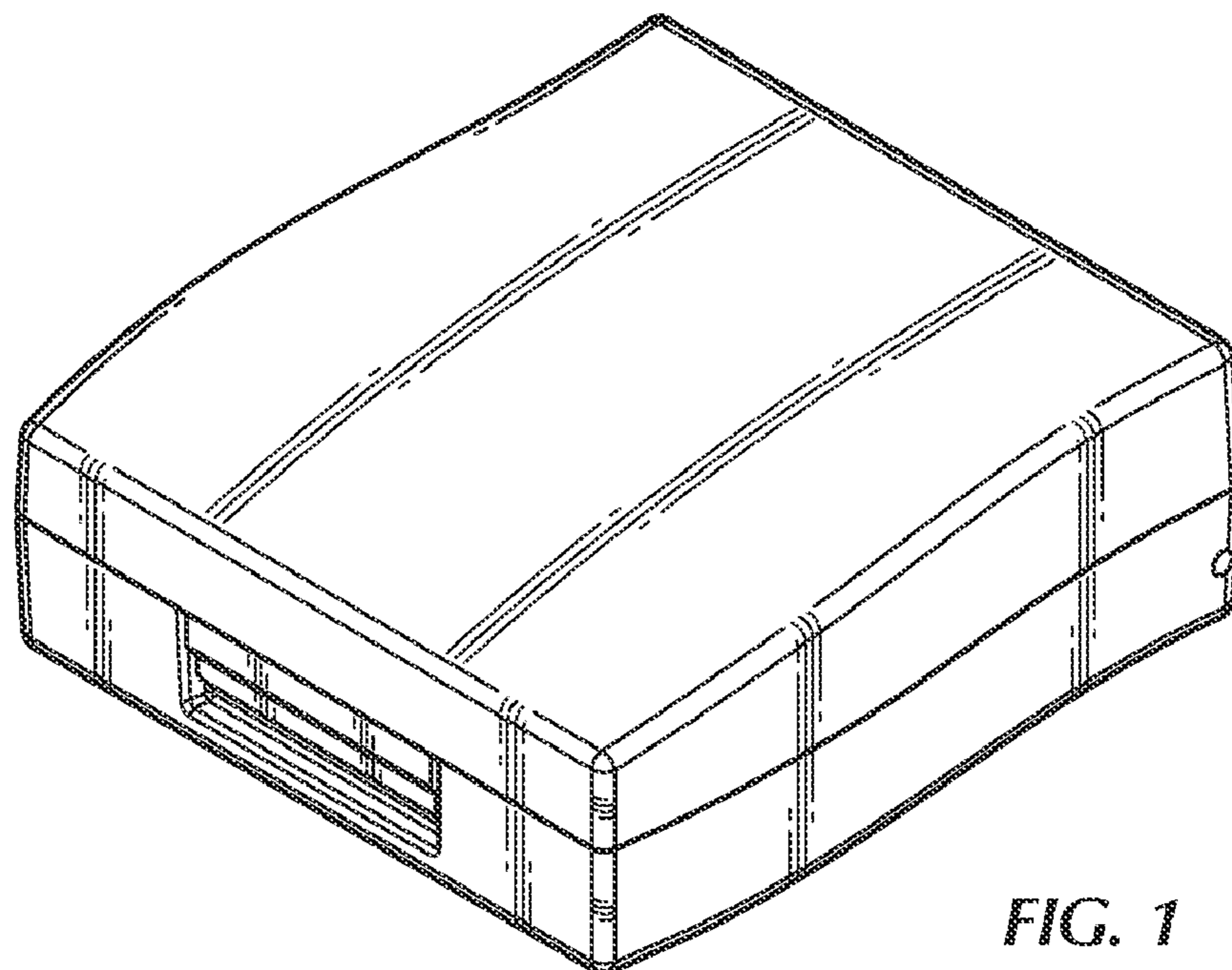

FIG. 1

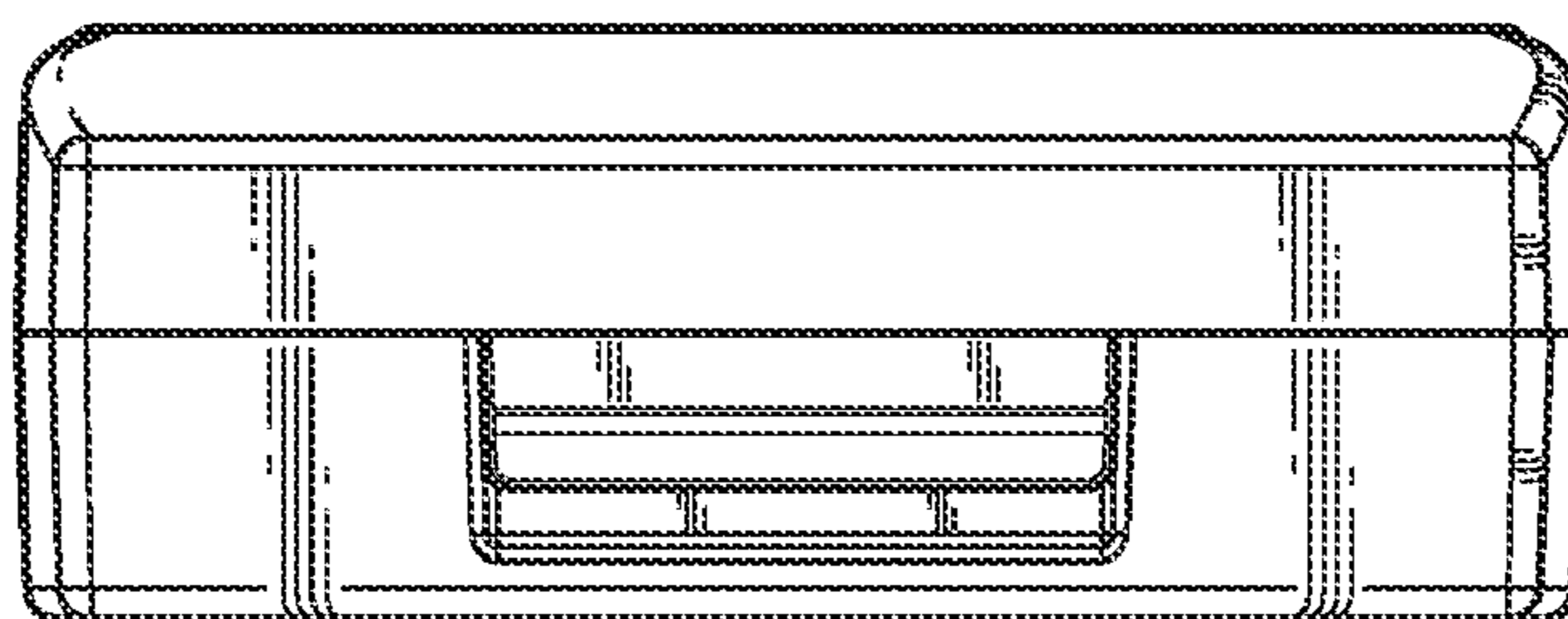

FIG. 2

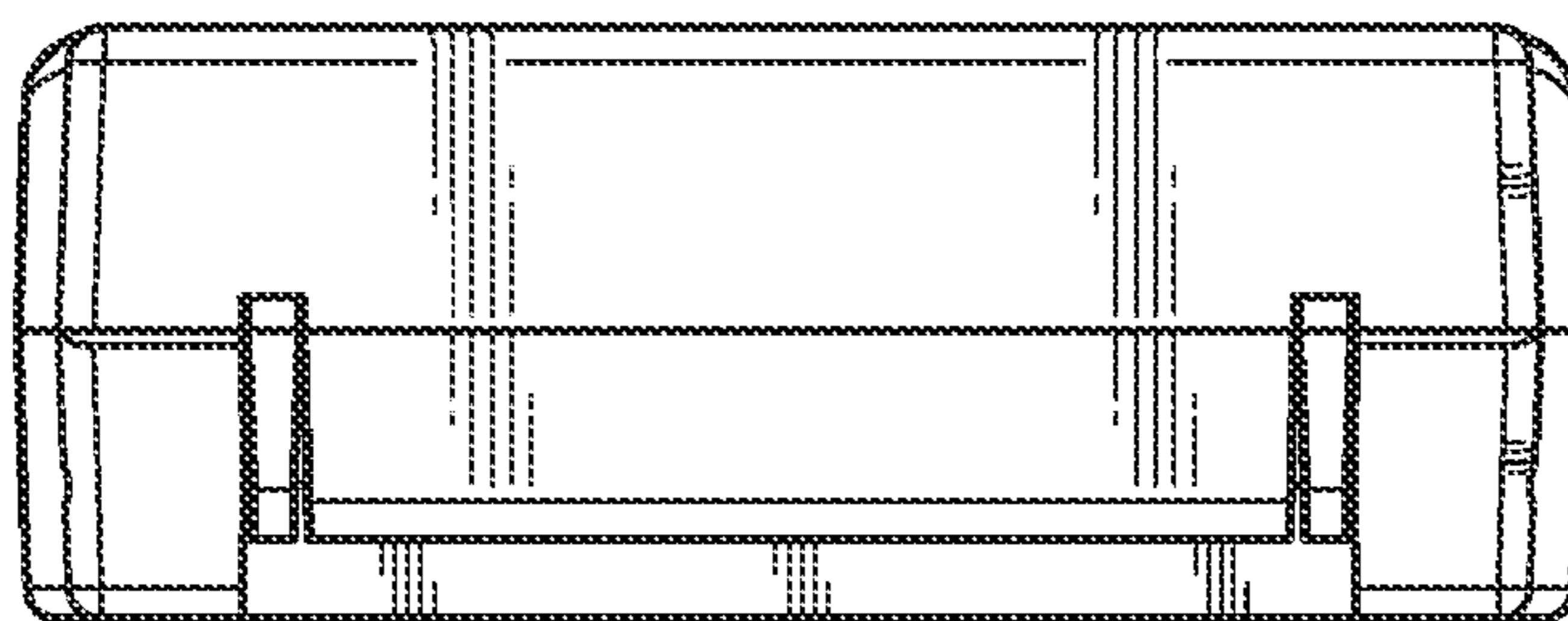

FIG. 3

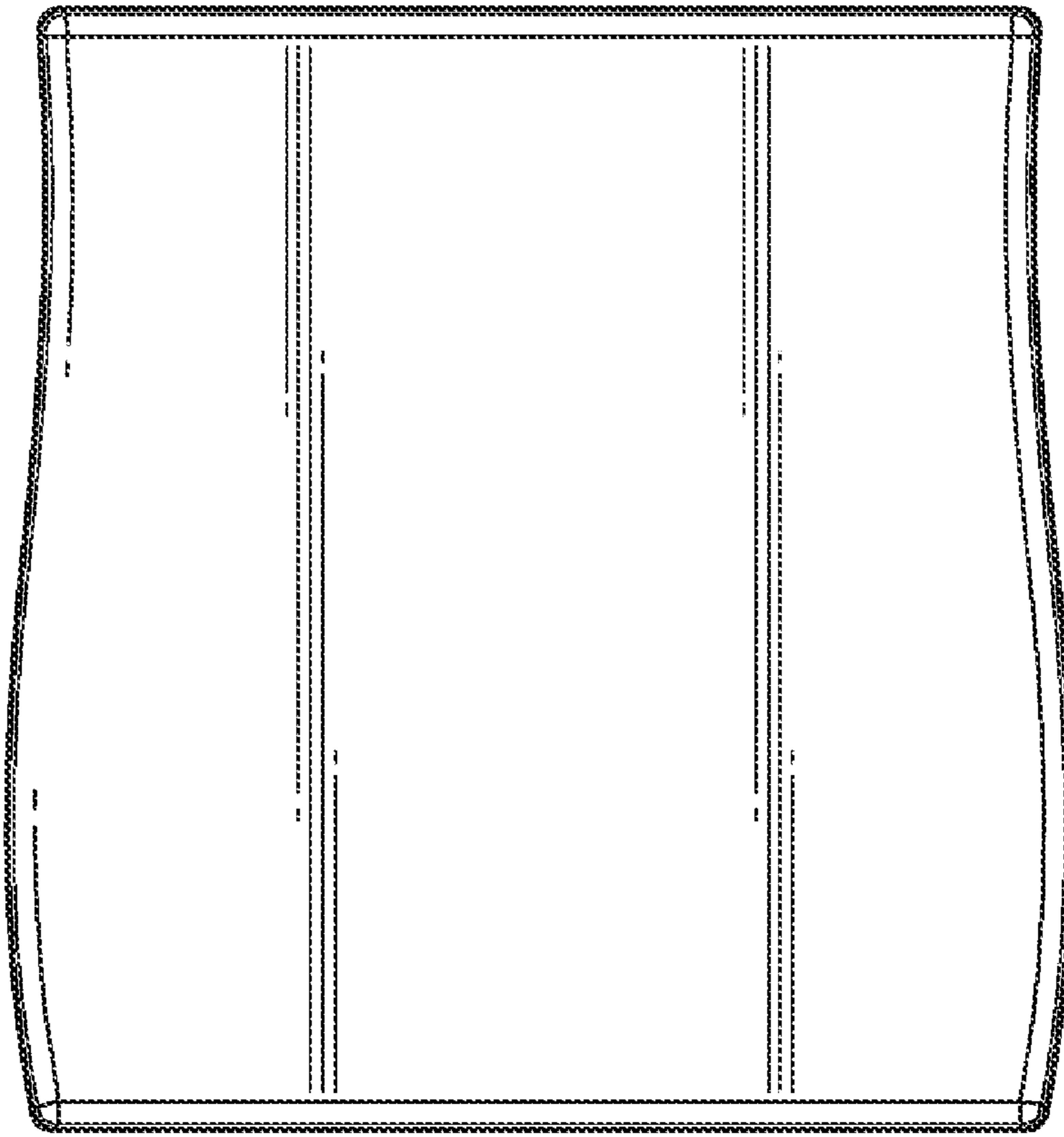

FIG. 4

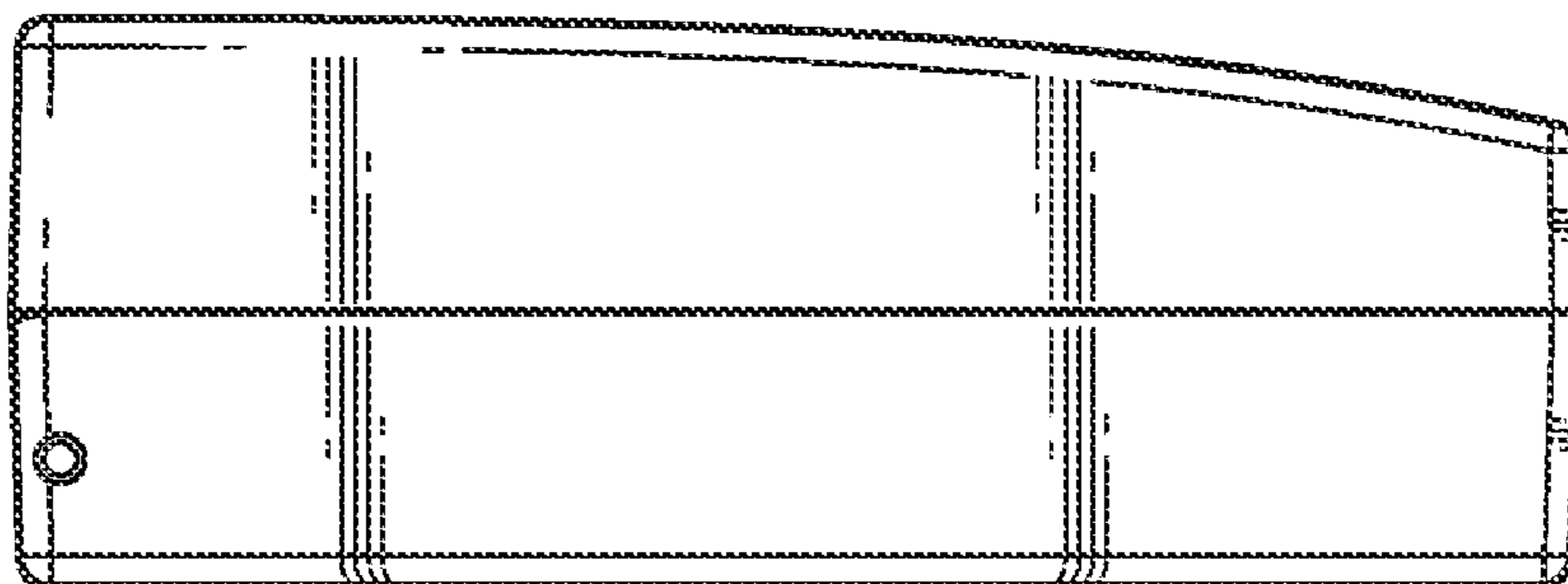

FIG. 5



FIG. 6

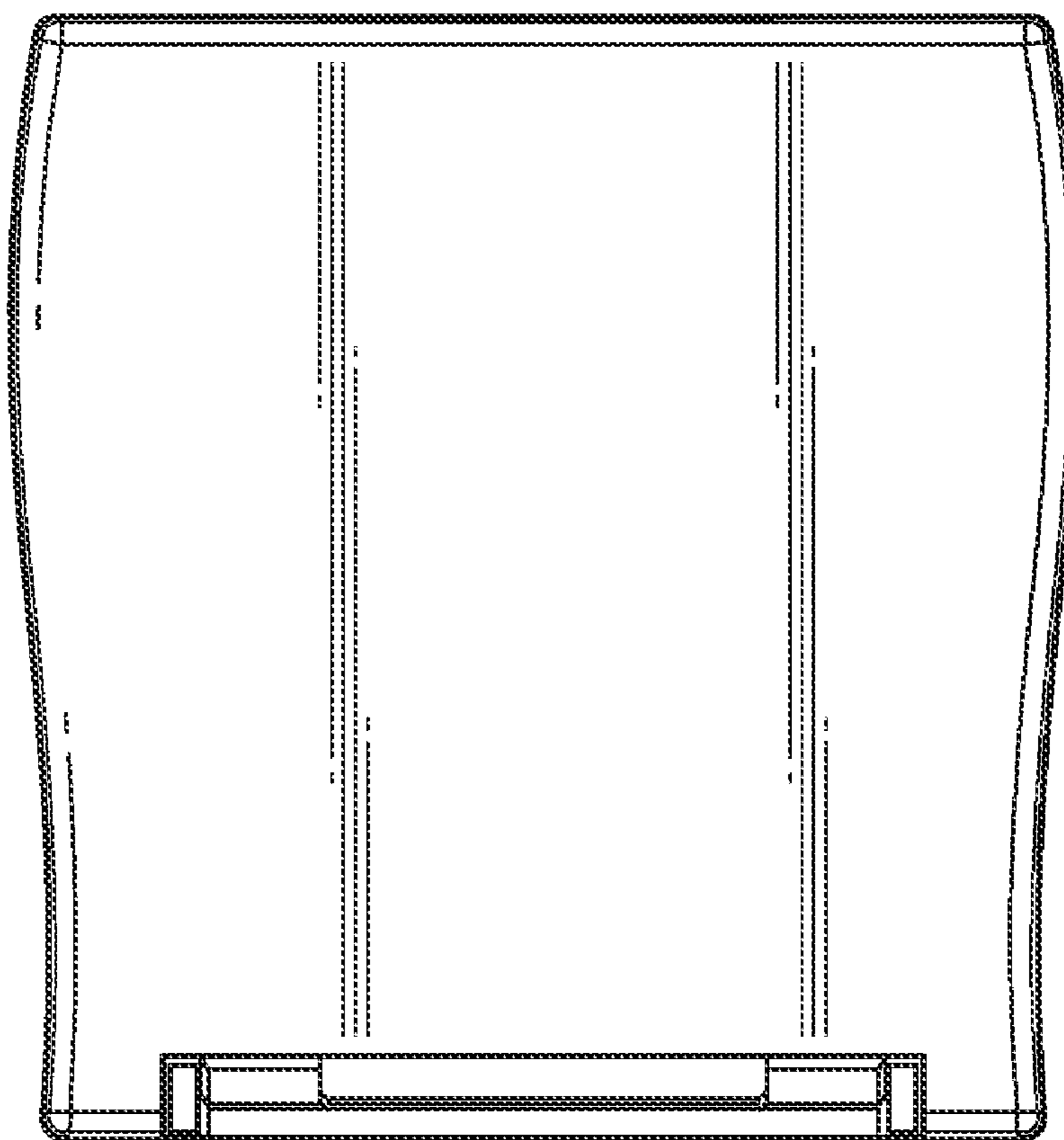

FIG. 7