



US00D627518S

(12) **United States Design Patent**
Kinard et al.

(10) **Patent No.:** **US D627,518 S**
(45) **Date of Patent:** **** Nov. 16, 2010**

(54) **RAZOR CARTRIDGE LUBRICATION RING**

(75) Inventors: **Jennifer Ruth Kinard**, Cambridge, MA (US); **Andrew Anthony Szczepanowski**, North Attleboro, MA (US); **Robert Harold Johnson**, Melrose, MA (US)

(73) Assignee: **The Gillette Company**, Boston, MA (US)

(**) Term: **14 Years**

(21) Appl. No.: **29/365,764**

(22) Filed: **Jul. 14, 2010**

Related U.S. Application Data

(62) Division of application No. 29/351,222, filed on Dec. 2, 2009, now Pat. No. Des. 622,904.

(51) **LOC (9) Cl.** **28-03**

(52) **U.S. Cl.** **D28/47**

(58) **Field of Classification Search** D28/44-48;
30/32, 34.05, 34.1-34.2, 41, 44-46, 47-51,
30/57-58, 77-84, 526-539

See application file for complete search history.

(56) **References Cited**

U.S. PATENT DOCUMENTS

D547,494 S * 7/2007 Watson et al. D28/47
D550,400 S * 9/2007 Orloff et al. D28/47
D556,378 S * 11/2007 Watson et al. D28/47

D563,043 S * 2/2008 Ramm D28/47
D563,044 S * 2/2008 Ramm D28/47
D609,404 S * 2/2010 Peyser et al. D28/47
2007/0107231 A1 * 5/2007 Brown et al. 30/50
2007/0180700 A9 * 8/2007 Sandor et al. 30/41
2008/0209734 A1 * 9/2008 Nicoll 30/41
2008/0250646 A1 * 10/2008 Nakasuka 30/41

* cited by examiner

Primary Examiner—Jennifer Rivard

(74) *Attorney, Agent, or Firm*—Joanne N. Pappas; Kevin C. Johnson; Steven W. Miller

(57) **CLAIM**

The ornamental design for a razor cartridge lubrication ring, as shown and described.

DESCRIPTION

FIG. 1 is perspective view of a razor cartridge lubrication ring of the present design;

FIG. 2 is a front view thereof;

FIG. 3 is a back view thereof;

FIG. 4 is a right view thereof;

FIG. 5 is a left view thereof;

FIG. 6 is a top view thereof; and,

FIG. 7 is a bottom view thereof.

The dashed broken lines are directed to the environment and are for illustrative purposes only and form no part of the claimed design.

1 Claim, 5 Drawing Sheets

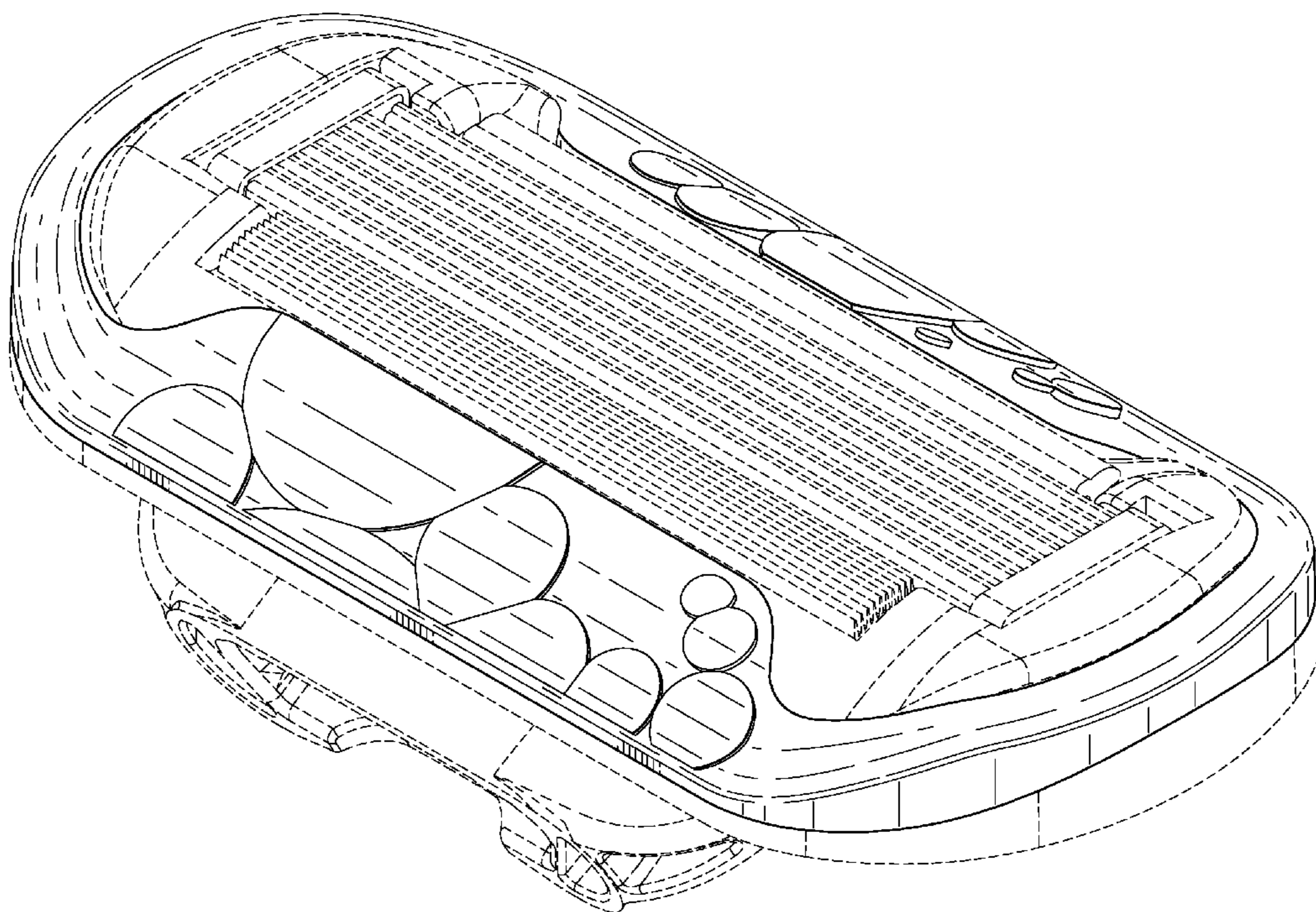

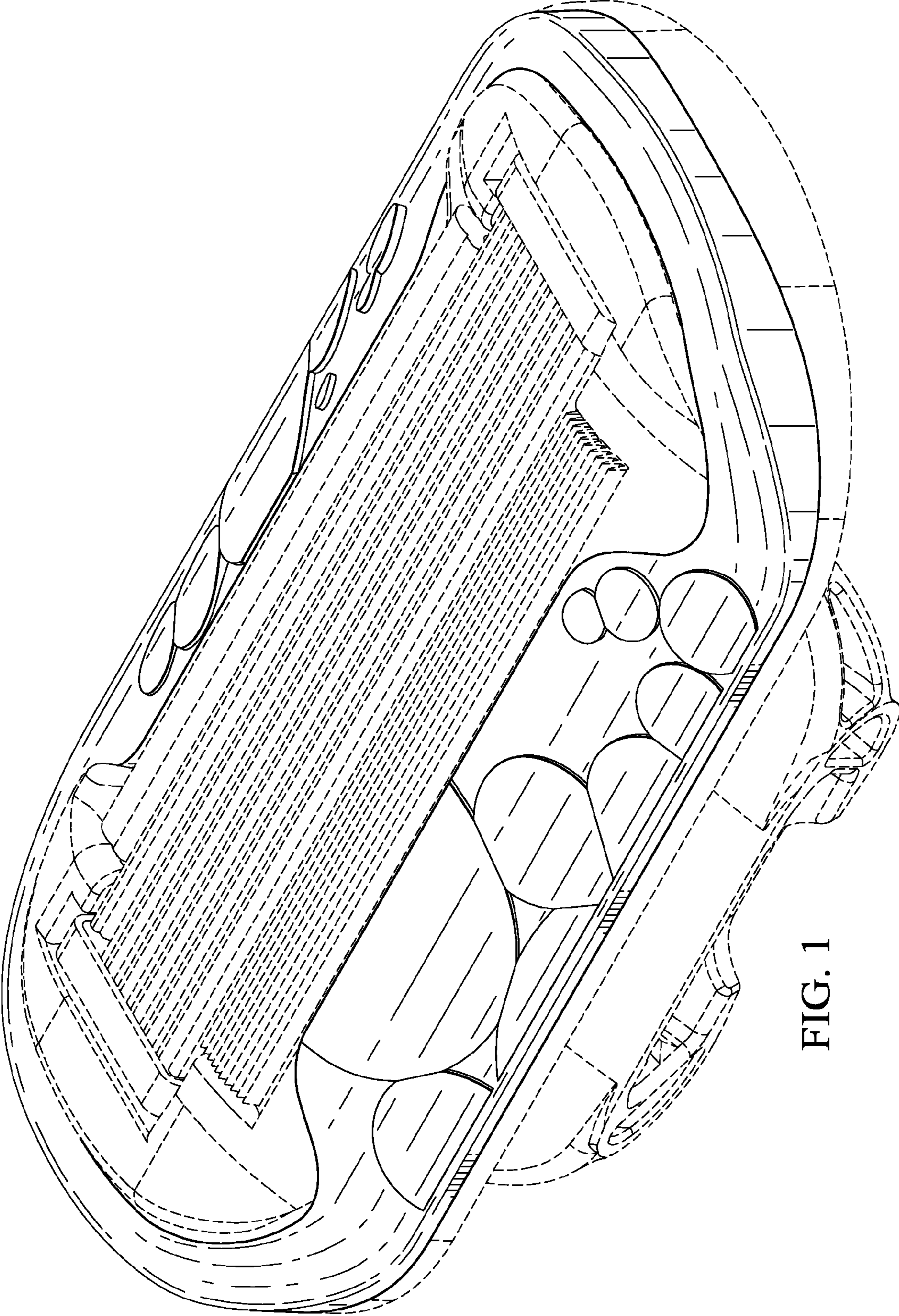

FIG. 1

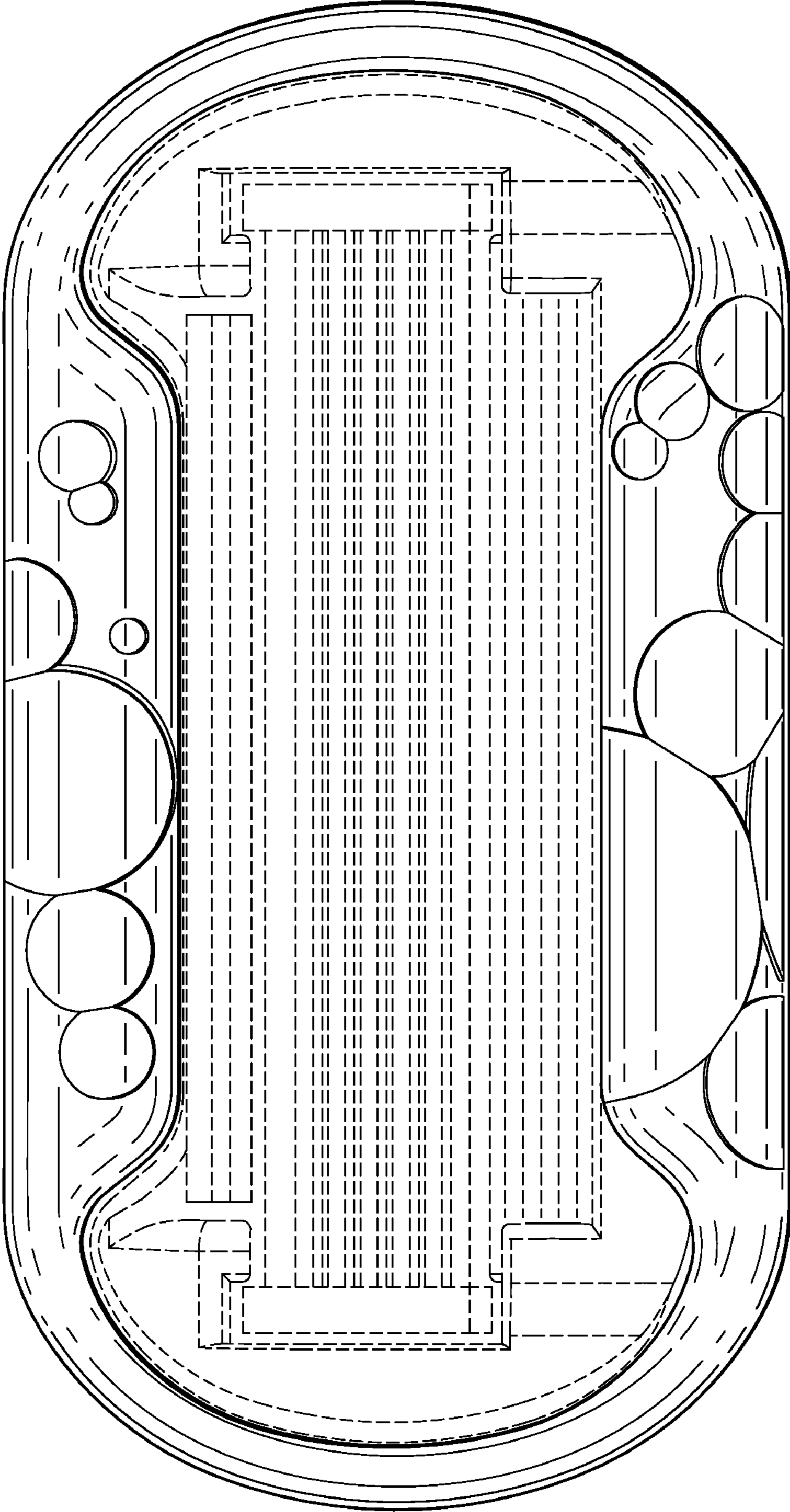

FIG. 2

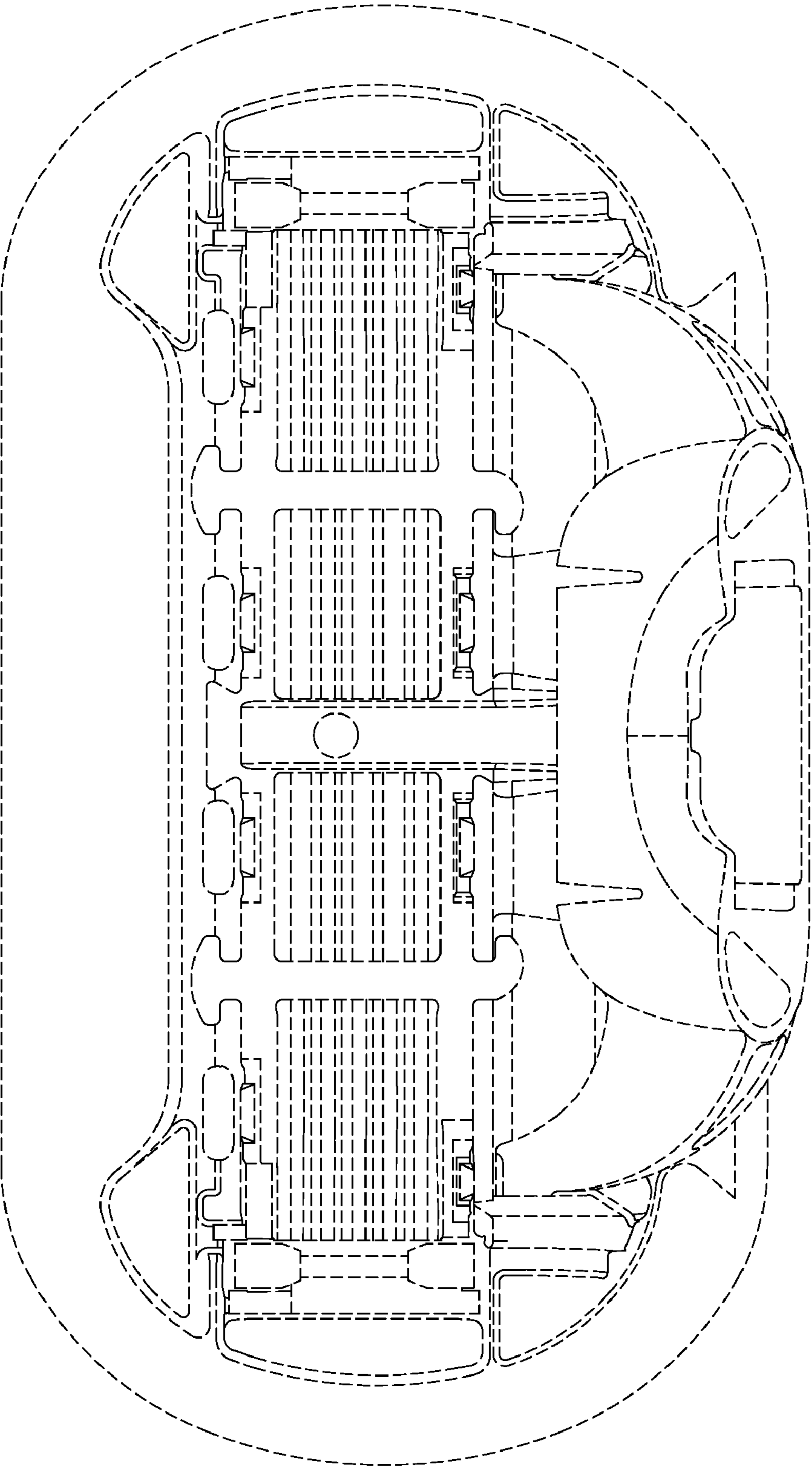

FIG. 3

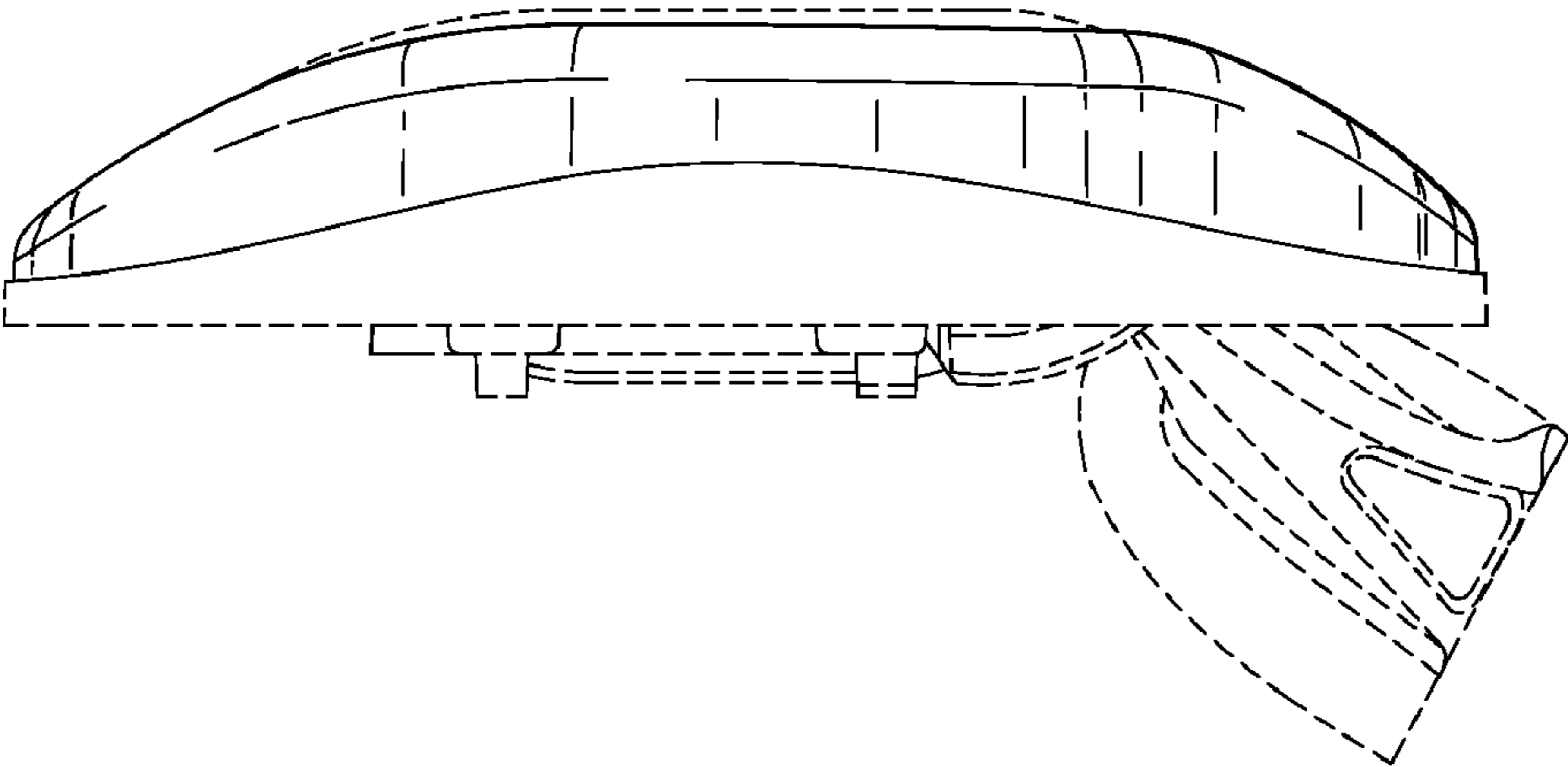

FIG. 5

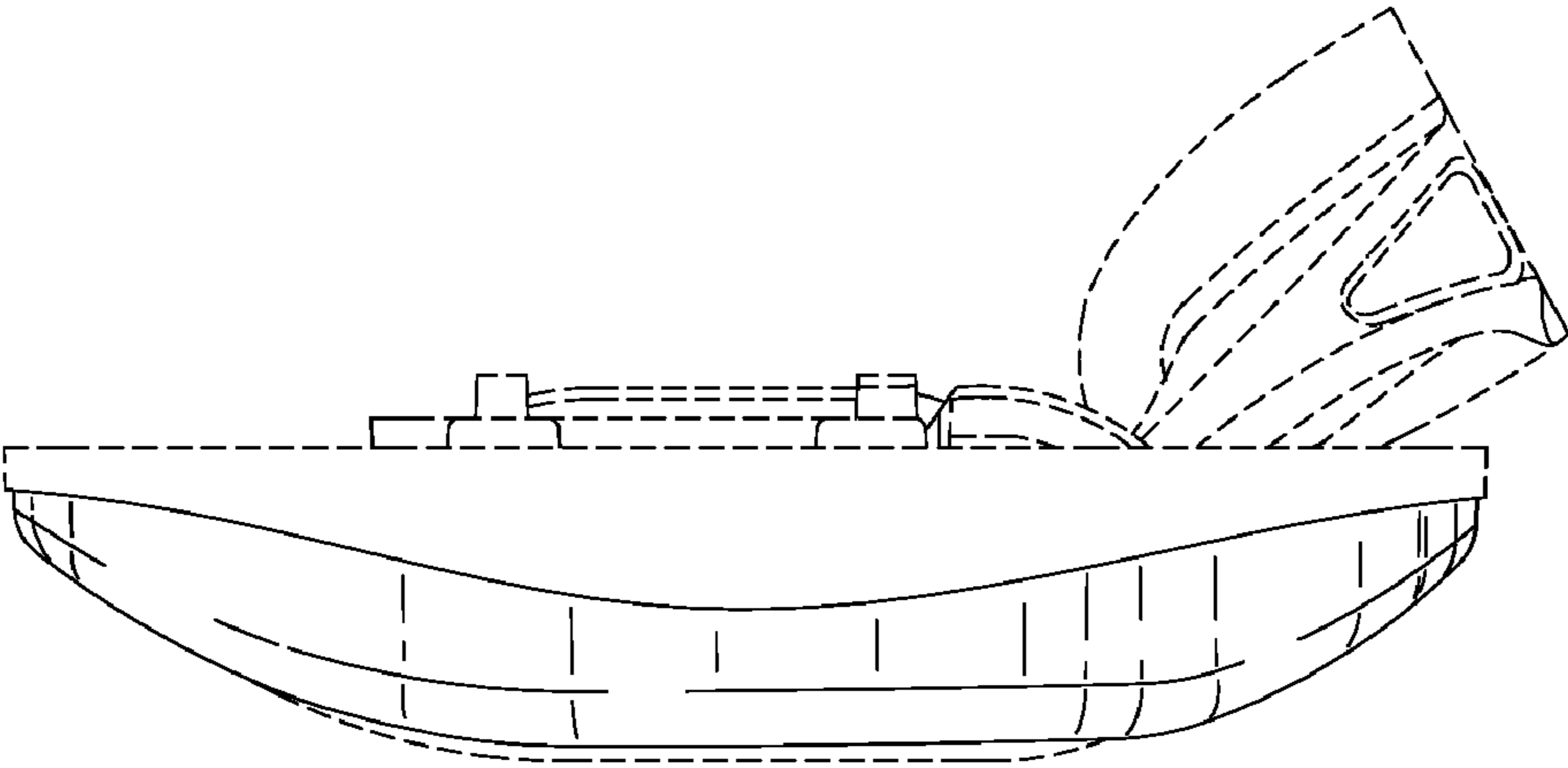

FIG. 4

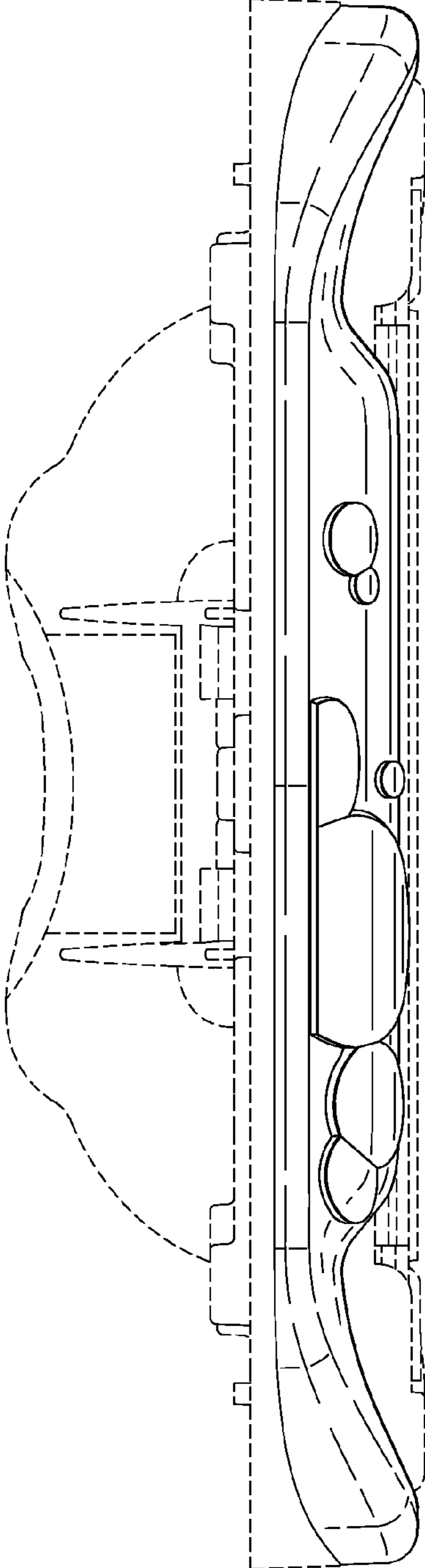

FIG. 6

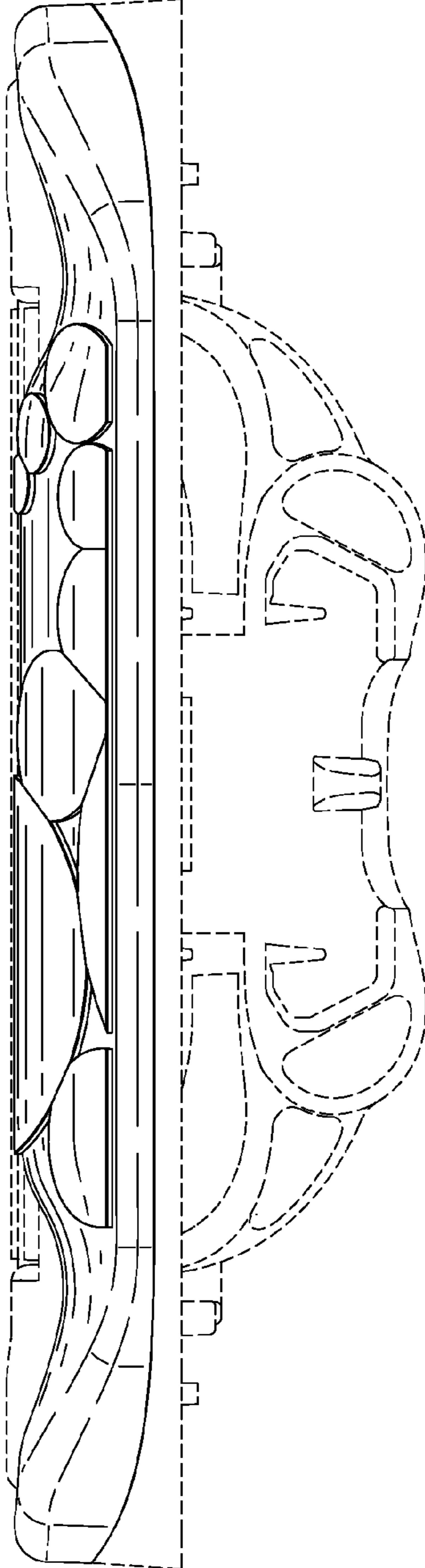

FIG. 7