



US00D627452S

(12) **United States Design Patent**
Chiu

(10) **Patent No.:** **US D627,452 S**
(45) **Date of Patent:** **** Nov. 16, 2010**

(54) **FAN HEATER**

D604,817 S * 11/2009 Lee D23/332

(75) Inventor: **Ming-Tsung Chiu**, Chung-Ho (TW)

* cited by examiner

(73) Assignee: **New Widetech Industries Co., Ltd.**,
Taipei Hsien (TW)

Primary Examiner—T. Chase Nelson
Assistant Examiner—Eric L Goodman
(74) *Attorney, Agent, or Firm*—William E. Pelton, Esq.;
Cooper & Dunham LLP

(**) Term: **14 Years**

(21) Appl. No.: **29/349,501**

(57) **CLAIM**

(22) Filed: **Apr. 9, 2010**

The ornamental design for a fan heater, as shown and described.

(51) **LOC (9) Cl.** **23-01**

(52) **U.S. Cl.** **D23/342**

(58) **Field of Classification Search** D23/317,
D23/332–342, 351, 355, 370, 378, 381, 364;
416/244 R, 247 R, 53.1, 53.2, 53.3; 392/365–369,
392/373–376

DESCRIPTION

See application file for complete search history.

FIG. 1 is a perspective view of a fan heater showing my new design;

FIG. 2 is a front view thereof;

FIG. 3 is a rear view thereof;

FIG. 4 is a left view thereof;

FIG. 5 is a right view thereof;

FIG. 6 is a top view thereof;

FIG. 7 is a bottom view thereof; and,

FIG. 8 is a rear perspective view thereof.

The broken lines are shown for illustrative purposes only and form no part of the claimed design.

(56) **References Cited**

U.S. PATENT DOCUMENTS

D158,149 S *	4/1950	Sundberg	D23/351
D497,985 S *	11/2004	Christianson	D23/364
D505,997 S *	6/2005	Maegawa	D23/332
D506,001 S *	6/2005	Christianson	D23/364
D506,249 S *	6/2005	Christianson	D23/364
D506,538 S *	6/2005	Christianson	D23/364
D514,678 S *	2/2006	Julos et al.	D23/364
D581,502 S *	11/2008	Gao	D23/332

1 Claim, 8 Drawing Sheets

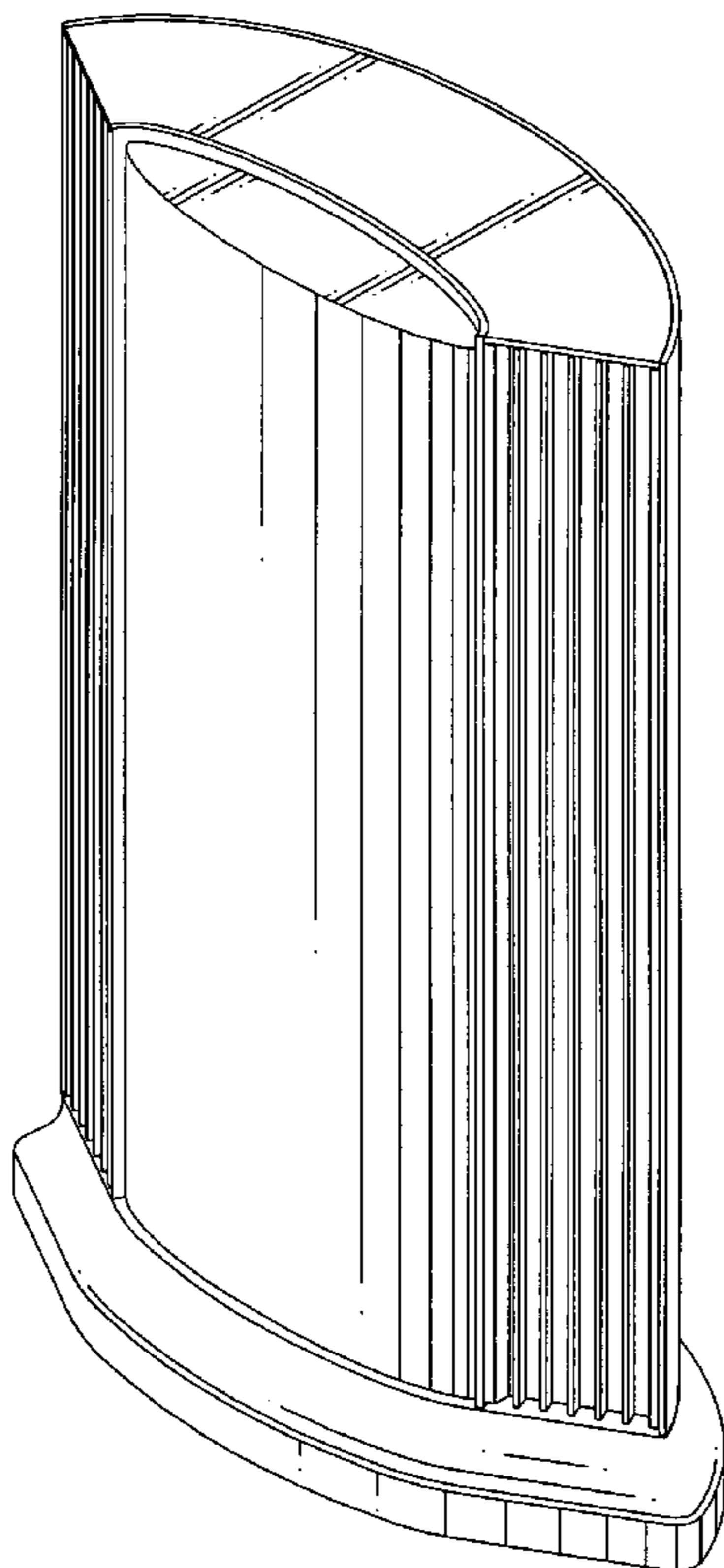

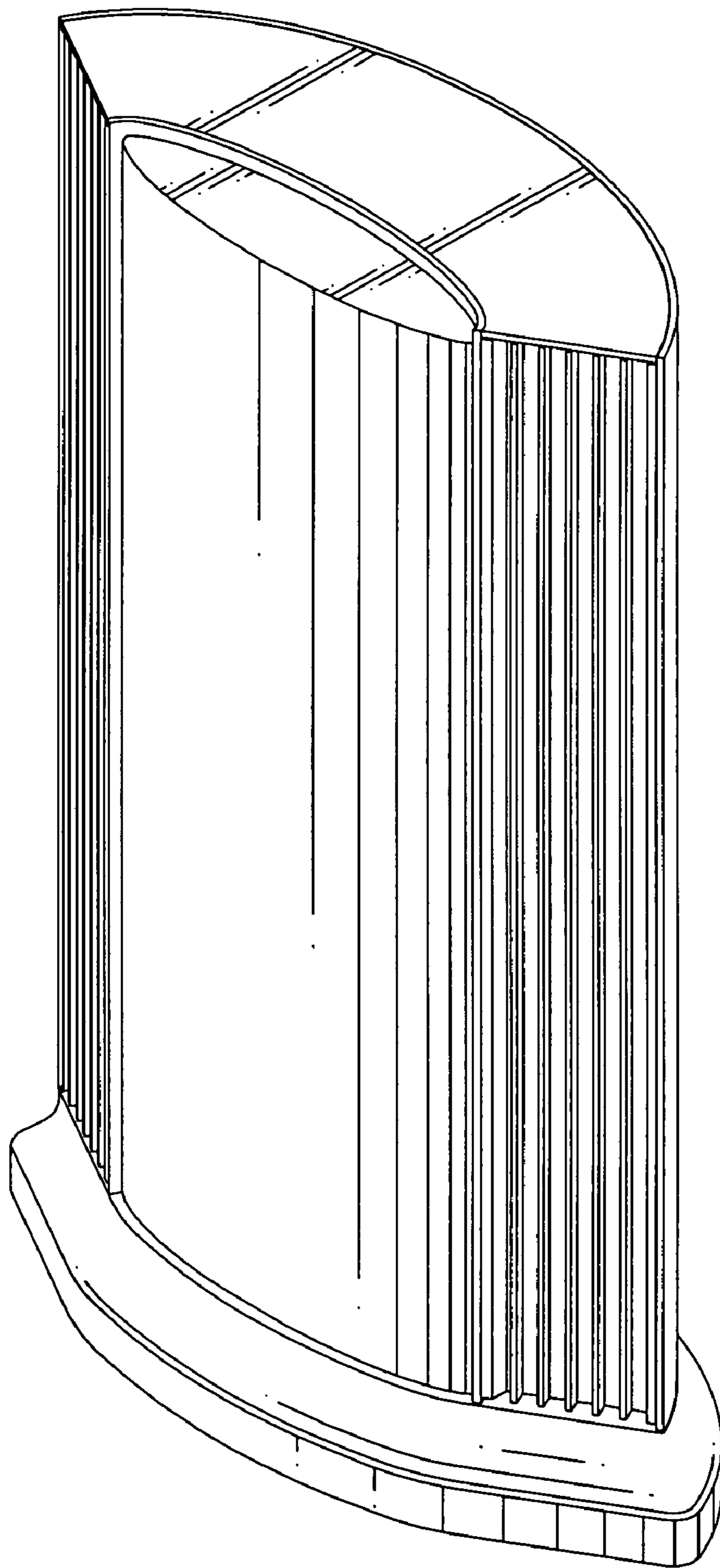

FIG.1

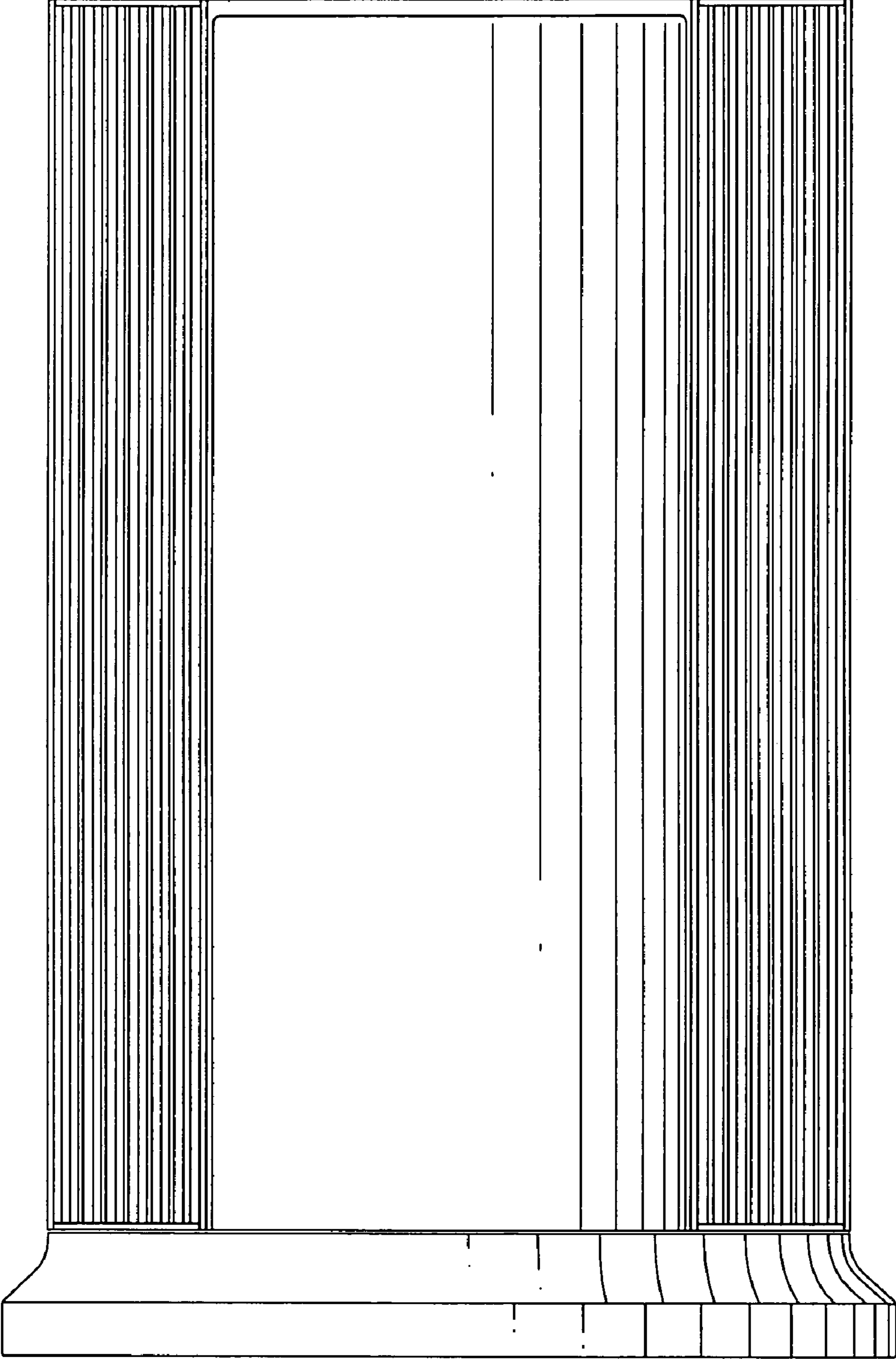

FIG.2

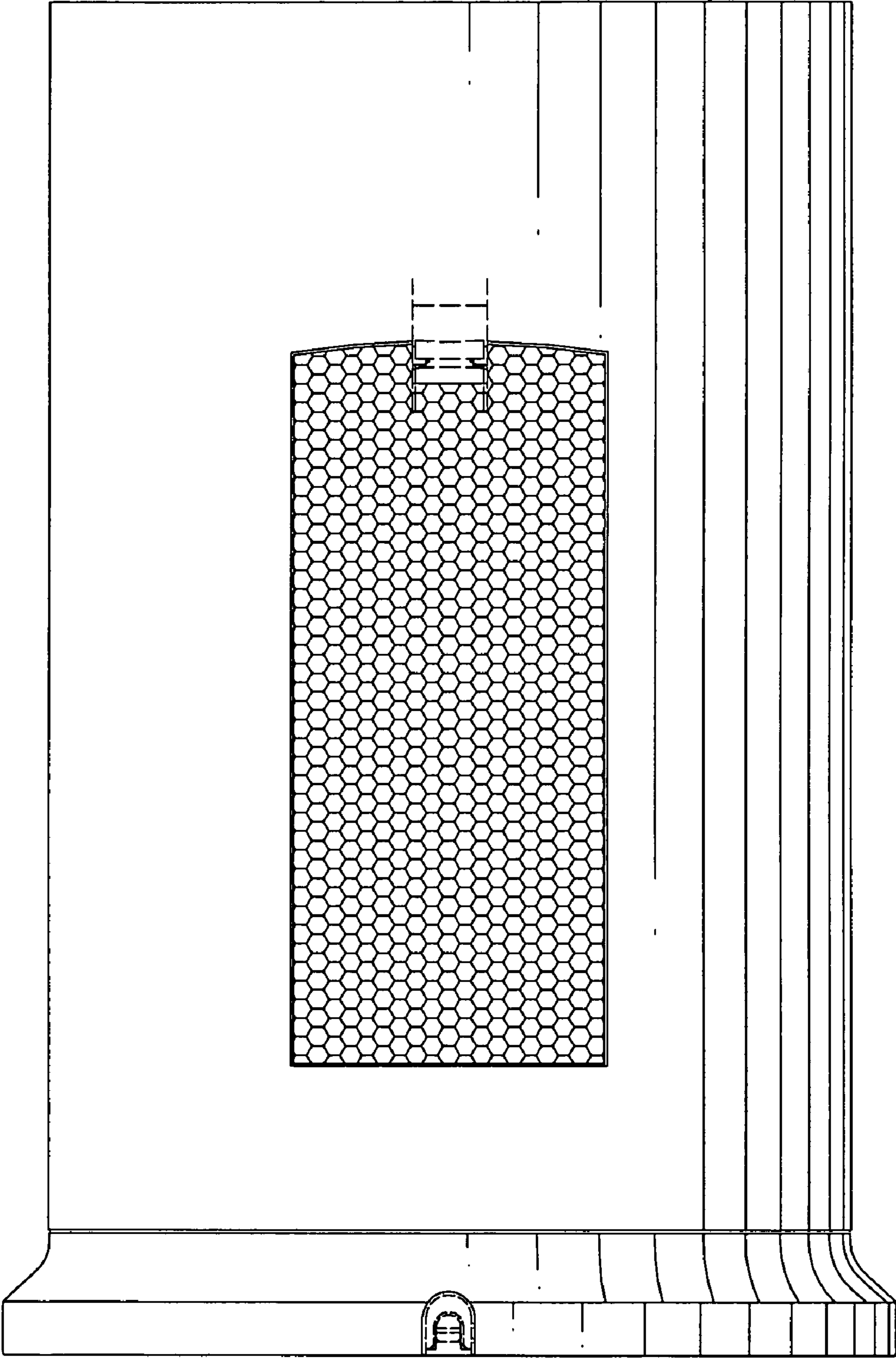

FIG.3

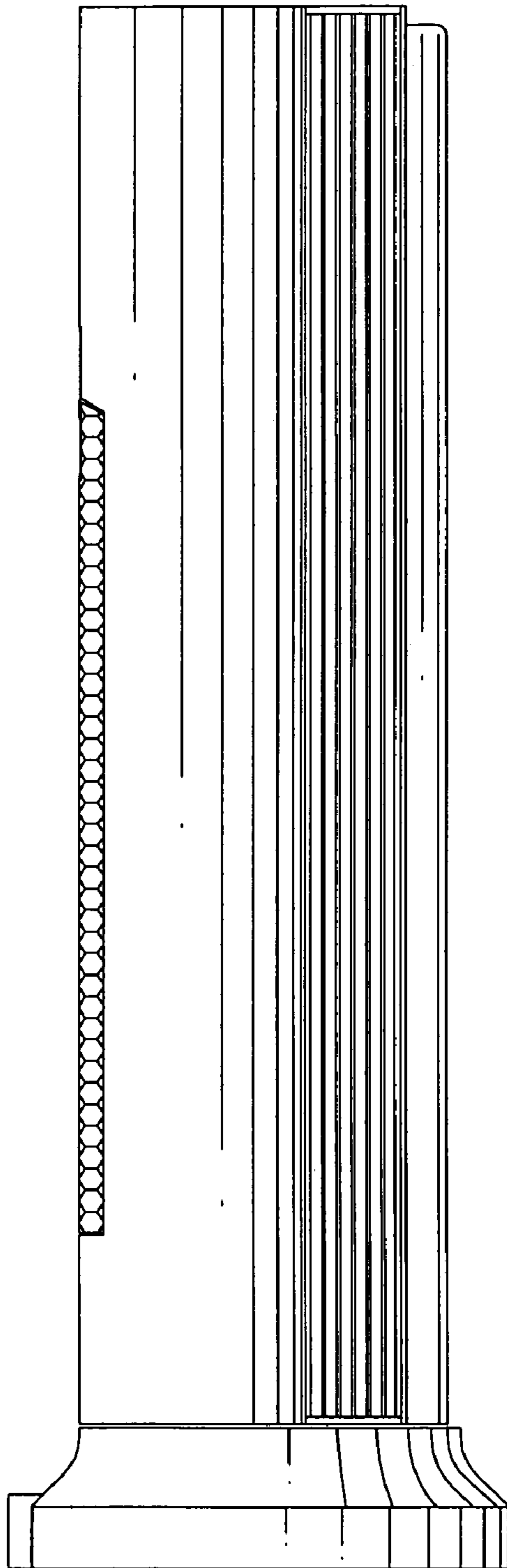

FIG.4

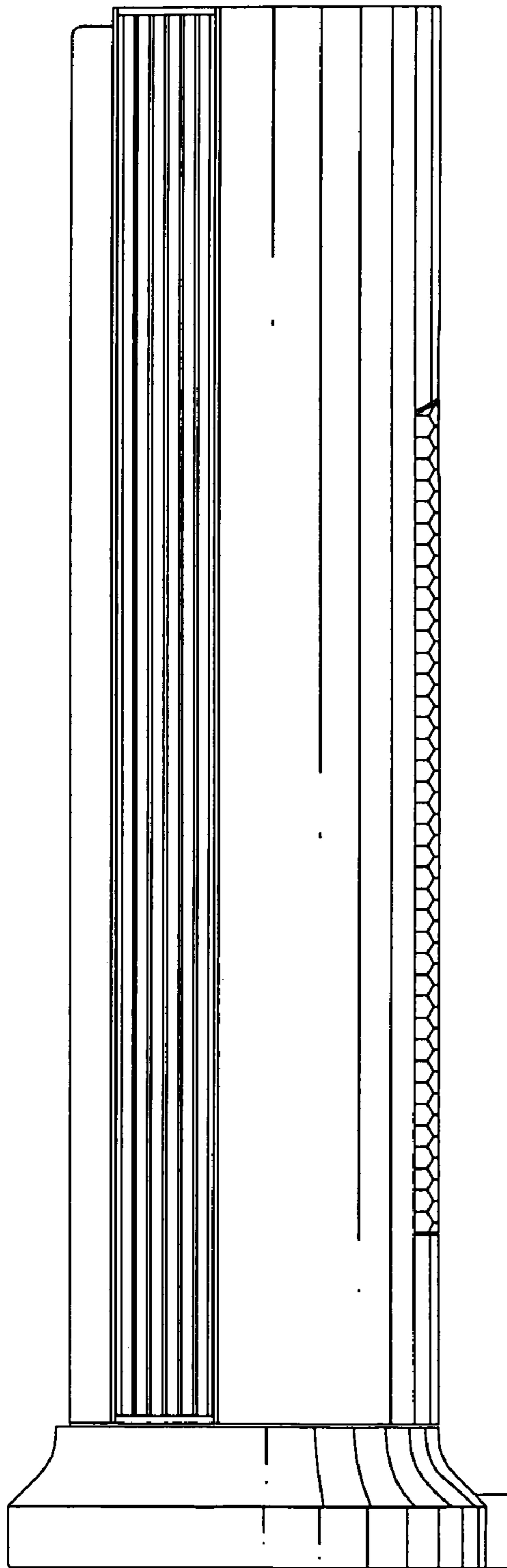

FIG.5

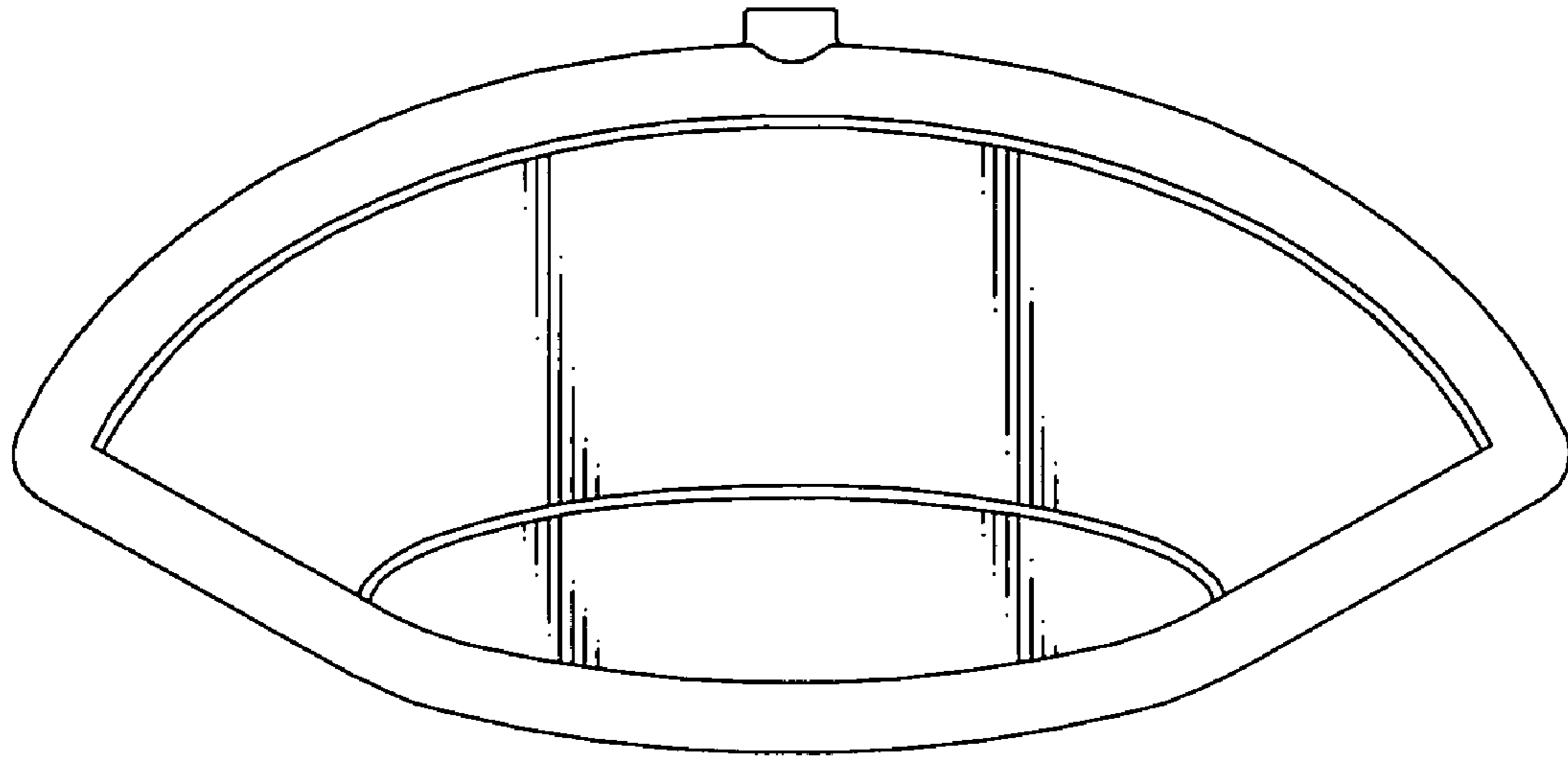

FIG.6

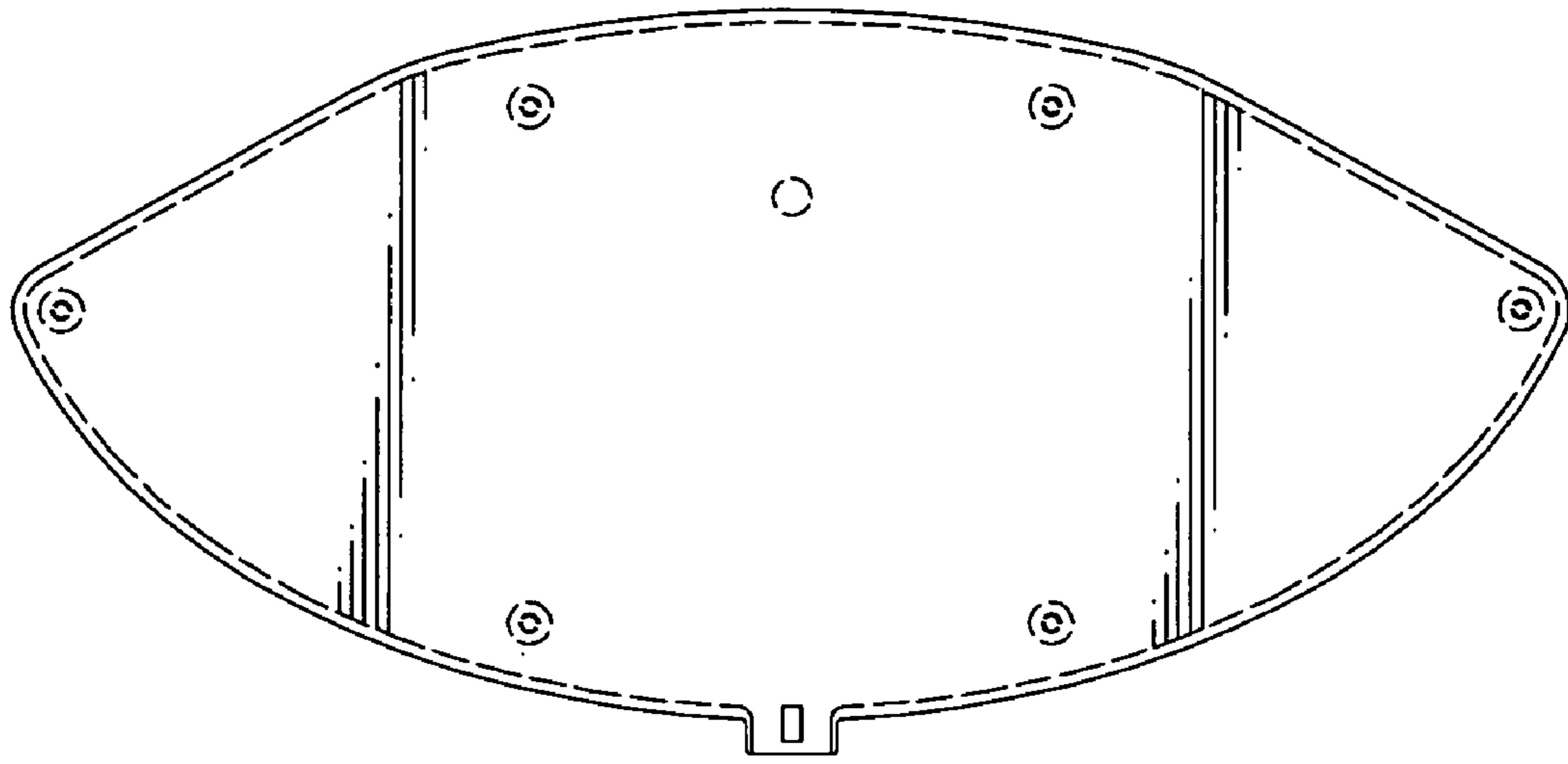

FIG.7

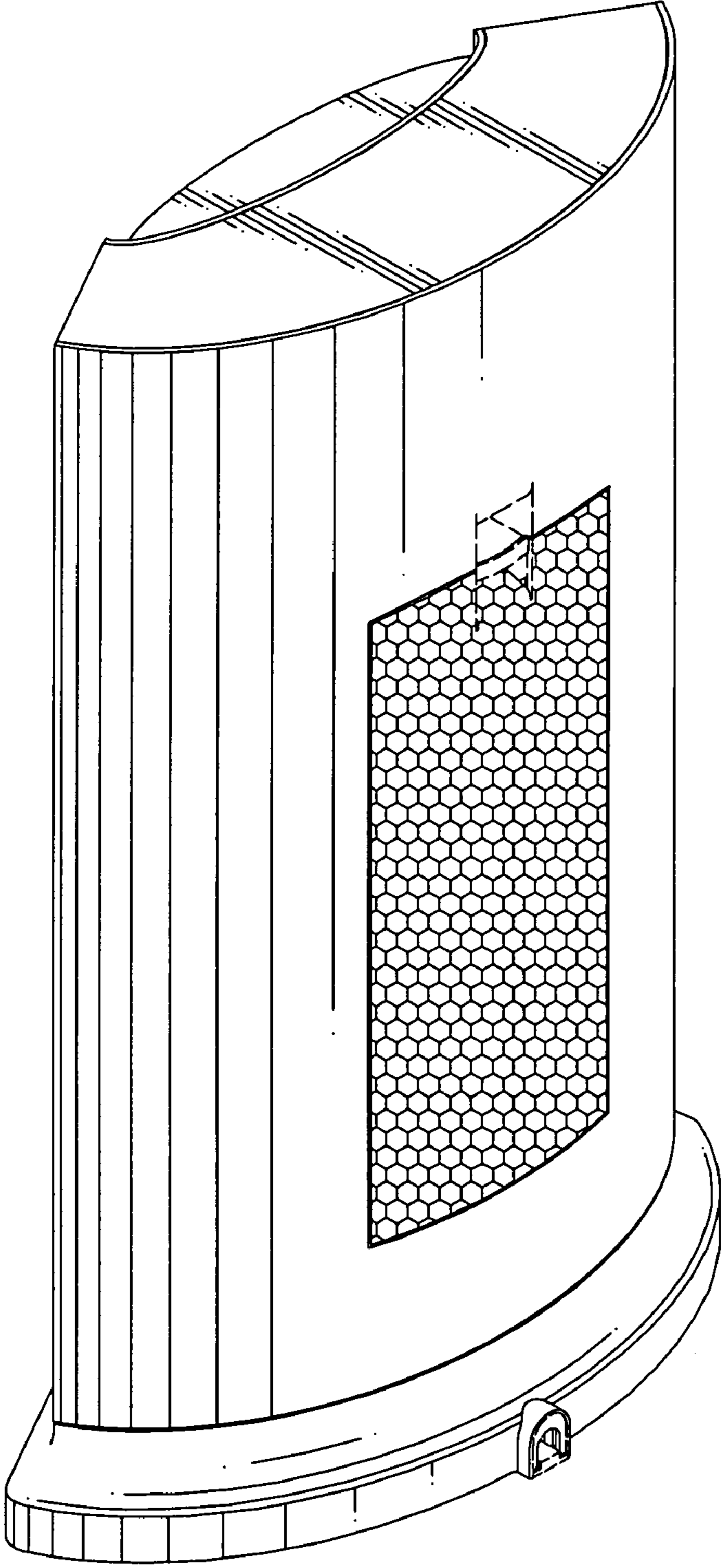

FIG.8