



US00D627428S

(12) **United States Design Patent**
Hamilton

(10) **Patent No.:** **US D627,428 S**

(45) **Date of Patent:** **** Nov. 16, 2010**

(54) **WATER COLLECTOR TANK**

(57) **CLAIM**

(76) **Inventor:** **Steve Hamilton**, P.O. Box 66284, St. Petersburg, FL (US) 33706

I claim the ornamental design for a water collector tank, as shown and described.

(**) **Term:** **14 Years**

DESCRIPTION

(21) **Appl. No.:** **29/354,571**

(22) **Filed:** **Jan. 26, 2010**

(51) **LOC (9) Cl.** **23-01**

(52) **U.S. Cl.** **D23/202**

(58) **Field of Classification Search** D23/202-205;
220/586-587, 565, 567.1, 581, 23.89

See application file for complete search history.

(56) **References Cited**

U.S. PATENT DOCUMENTS

D239,506 S *	4/1976	Myers	D23/202
5,450,978 A *	9/1995	Crisp et al.	220/565
D603,932 S *	11/2009	Natrass et al.	D23/202
D613,925 S *	4/2010	Chenkin	D34/39

* cited by examiner

Primary Examiner—Robin V Webster

(74) *Attorney, Agent, or Firm*—Larson & Larson, P.A.; Frank Liebenow

FIG. 1 is a front elevation view of the water collector tank showing my novel design;

FIG. 2 is a rear elevation view thereof;

FIG. 3 is a left side view thereof;

FIG. 4 is a right side view thereof;

FIG. 5 is a top plan view thereof;

FIG. 6 is a bottom plan view thereof;

FIG. 7 is a perspective view thereof, with the lid to the inner compartment open;

FIG. 8 is a perspective view thereof; and,

FIG. 9 is a left view thereof, including an unclaimed illustration of a typical environment of surrounding soil in which the water collector tank may be partially buried.

All of the broken line showing is included for the purpose of illustrating and forms no part of the claimed design.

1 Claim, 6 Drawing Sheets

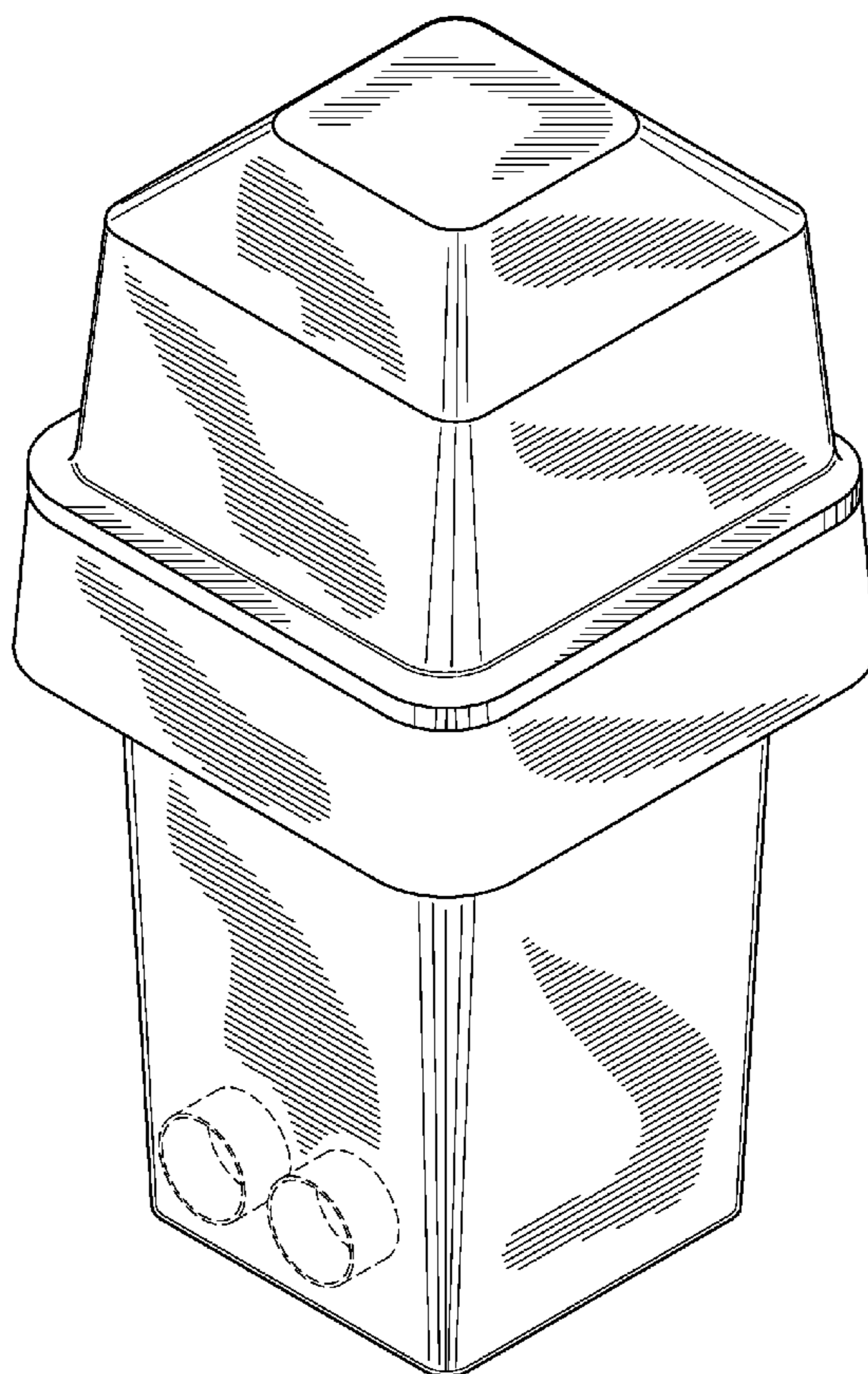

FIG. 1

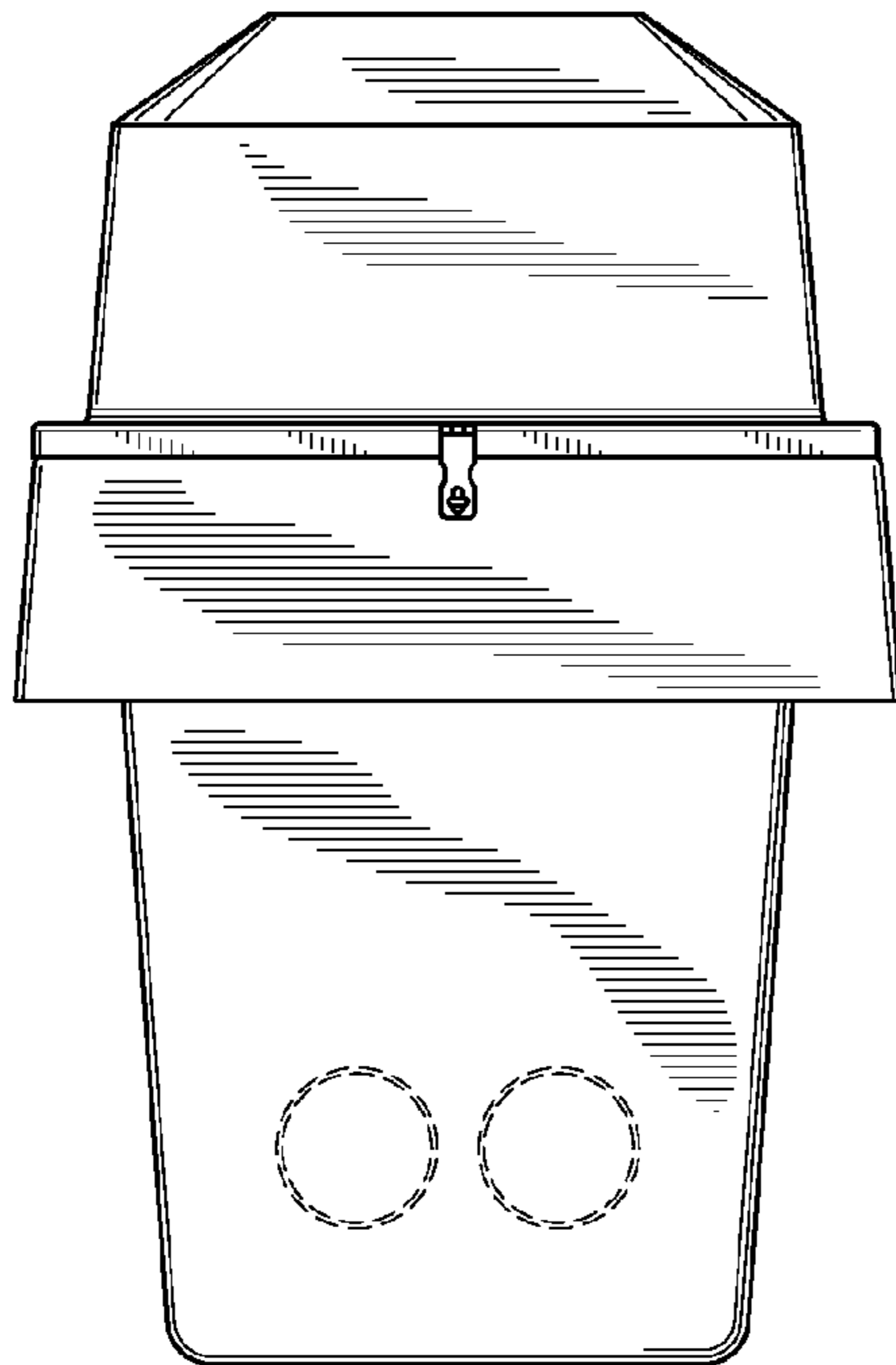

FIG. 2

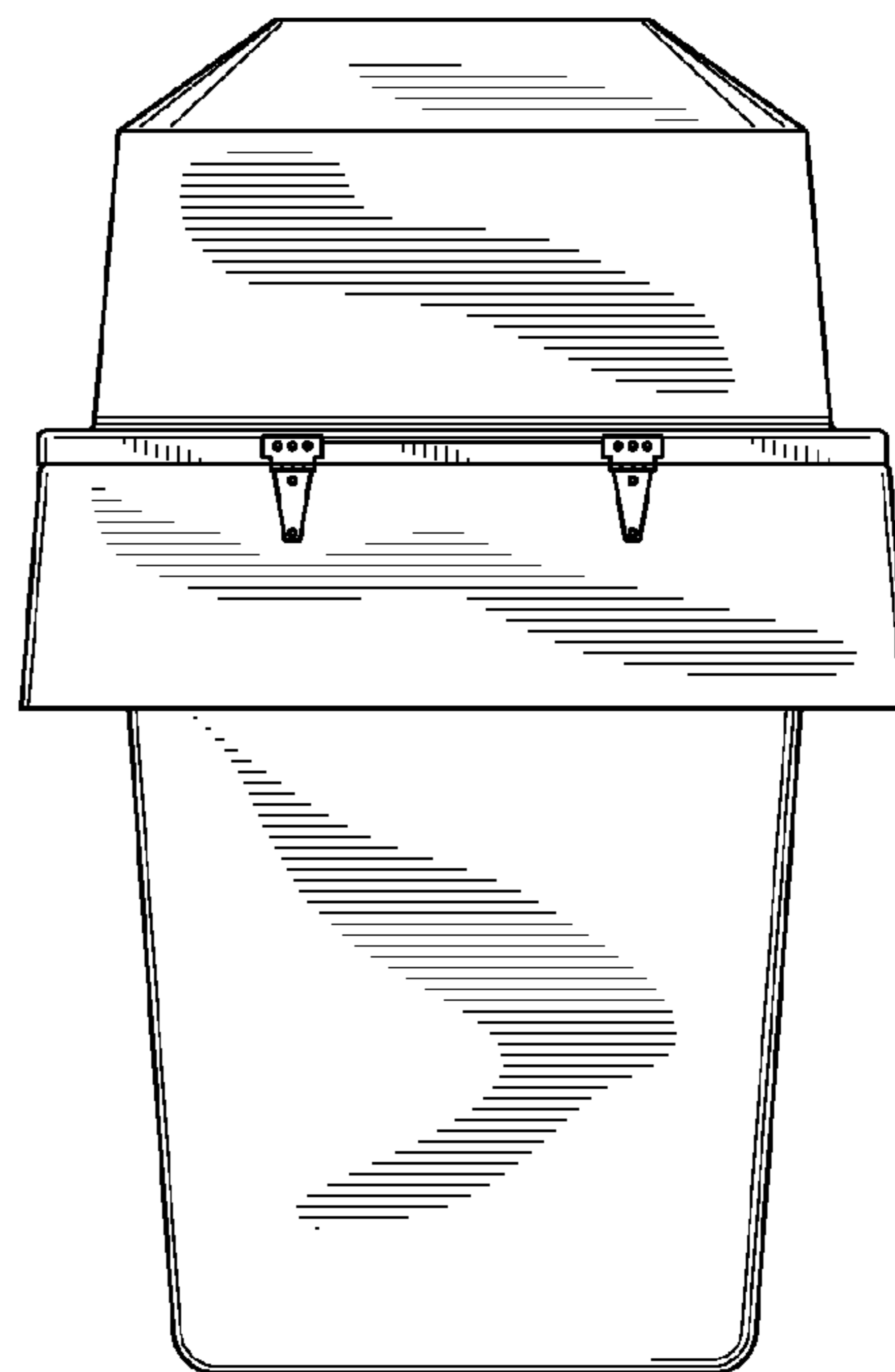

FIG. 3

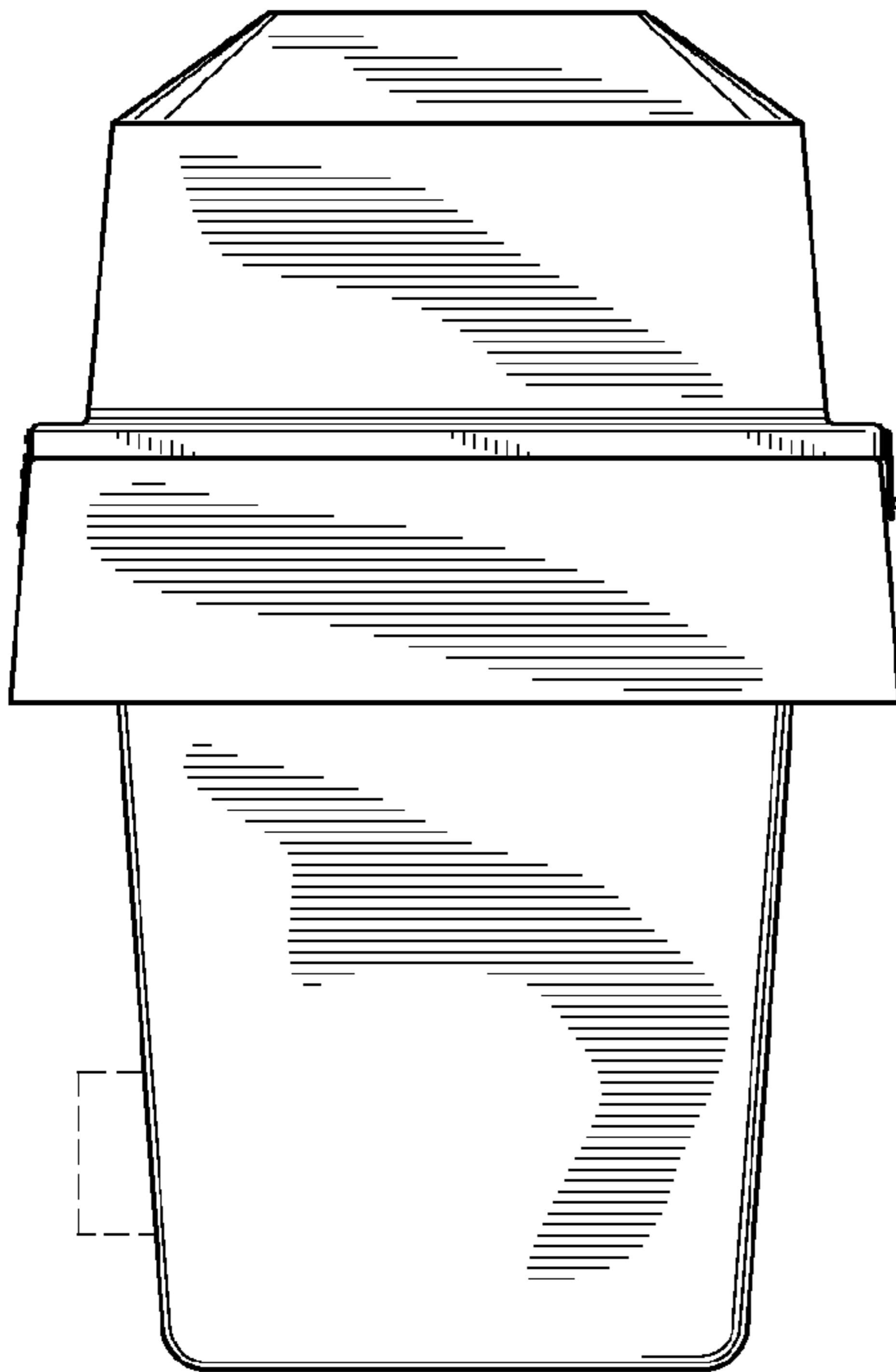

FIG. 4

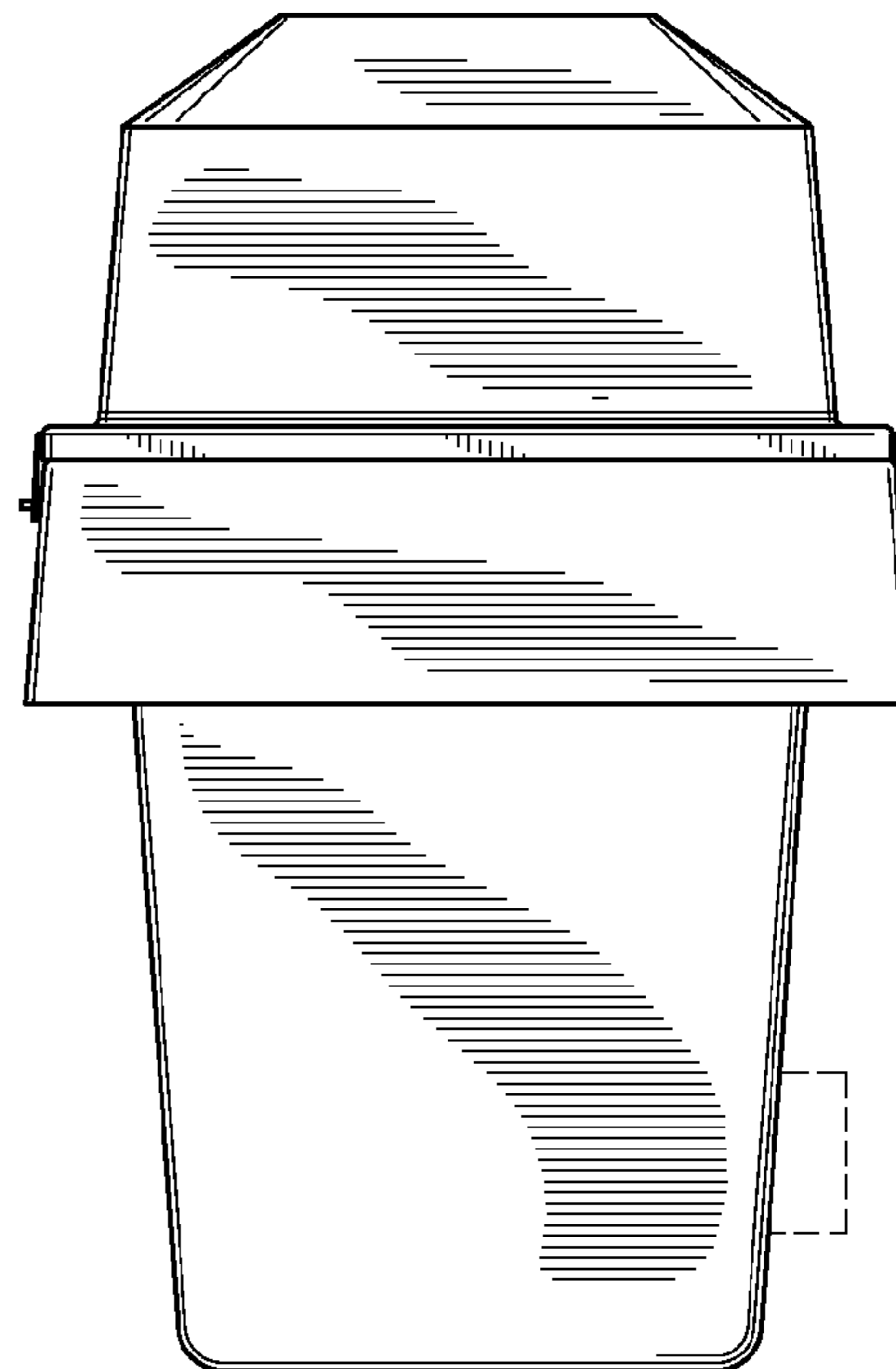

FIG. 5

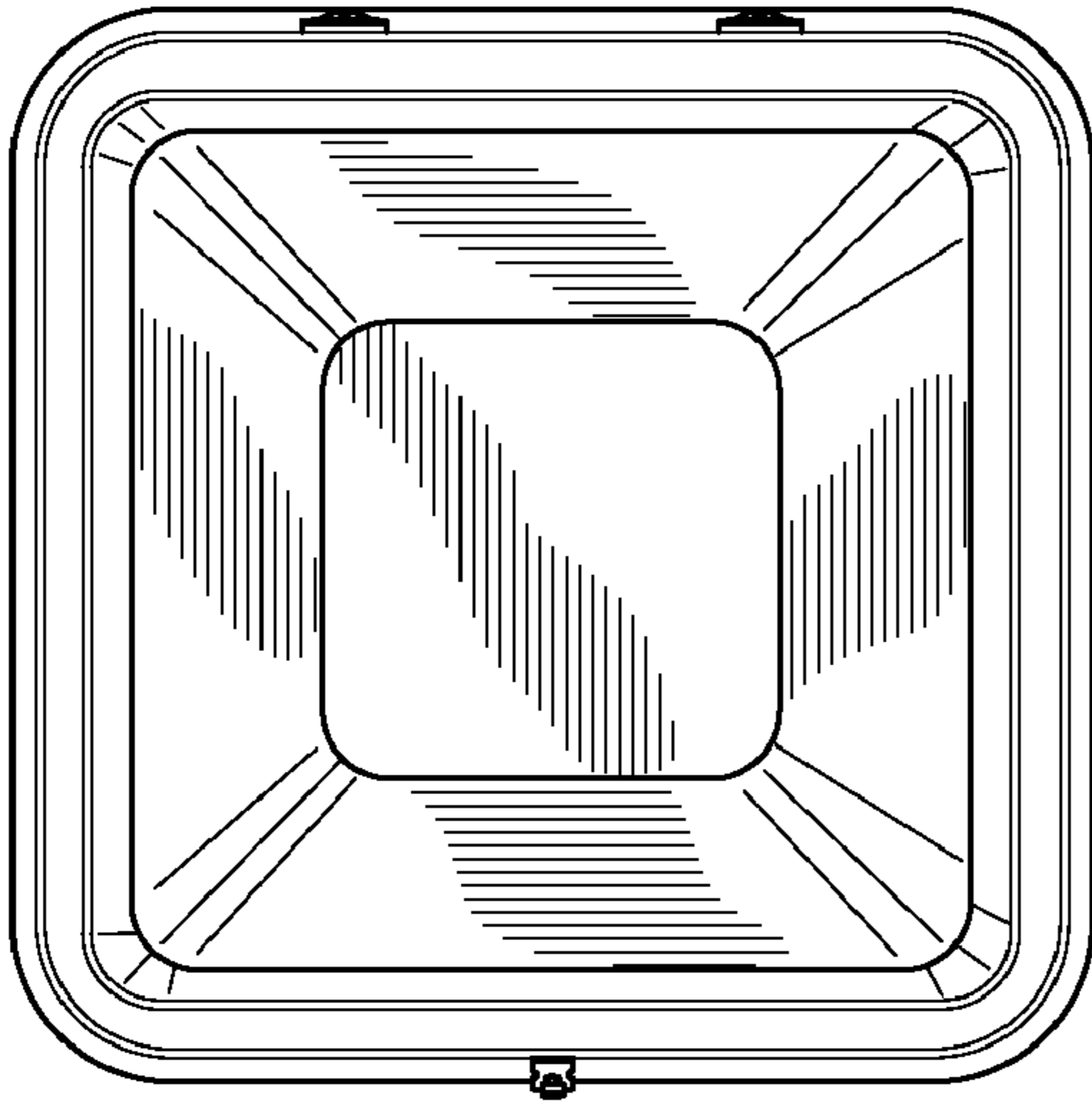

FIG. 6

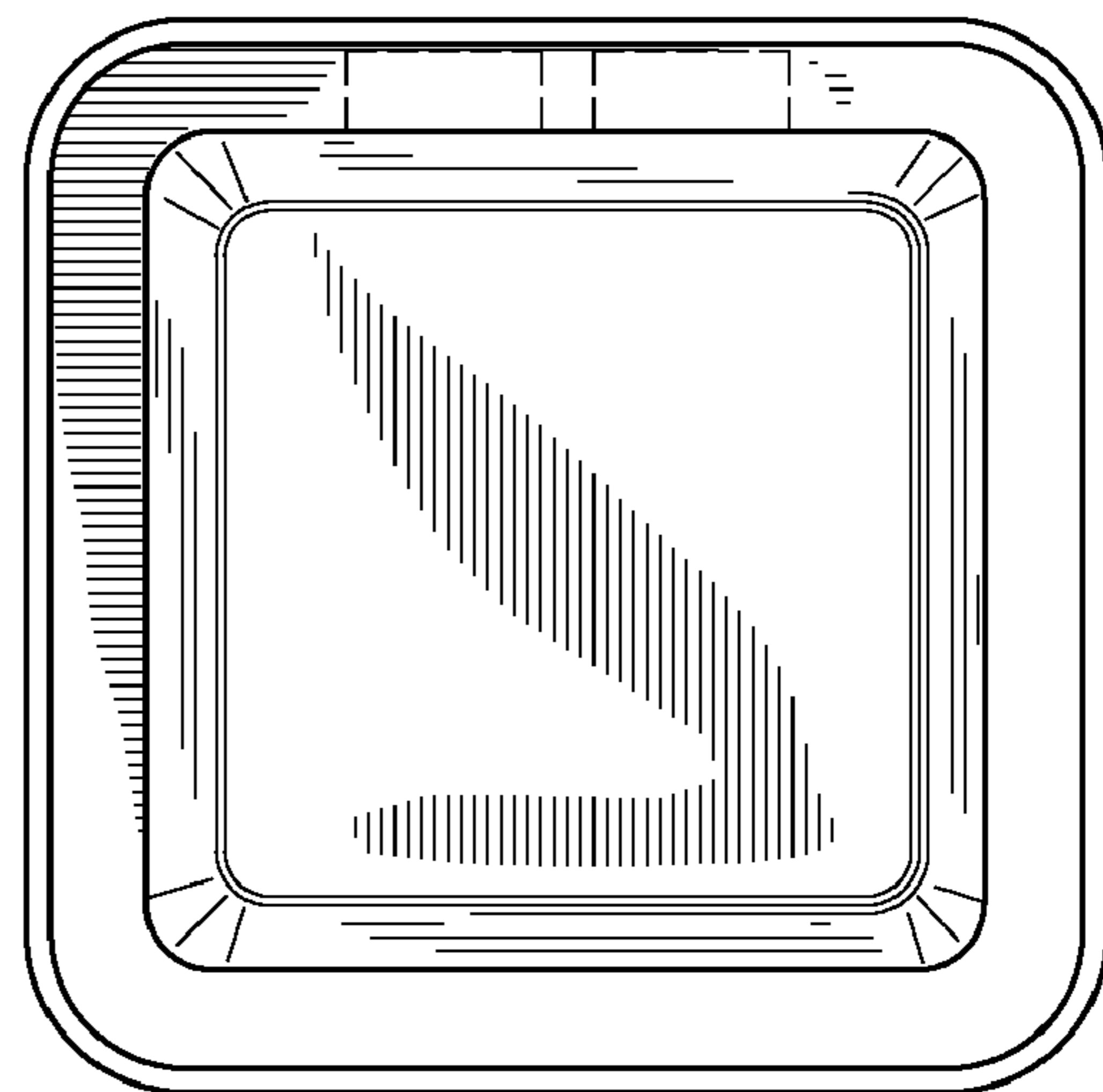

FIG. 7

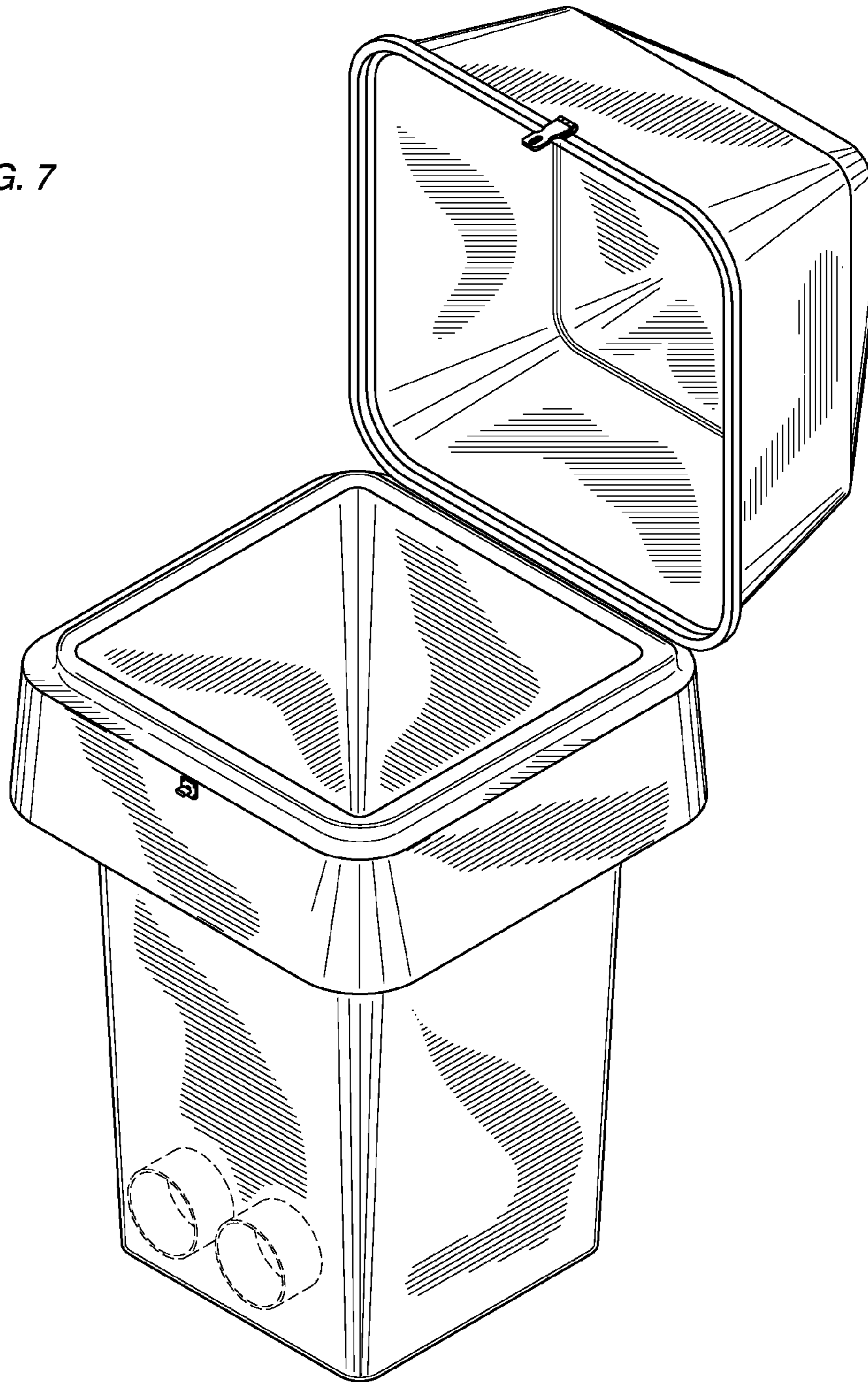

FIG. 8

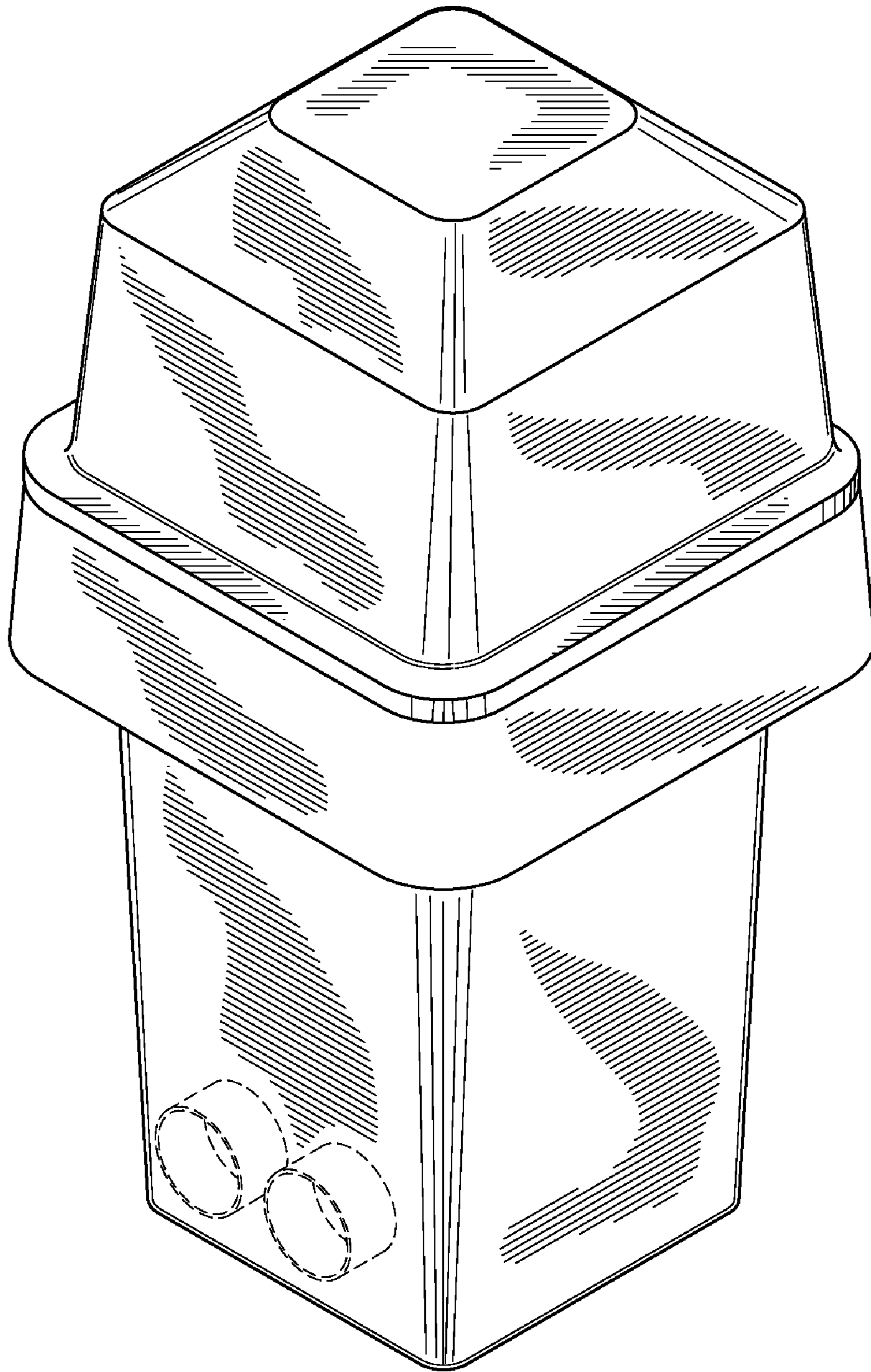

FIG. 9

