



US00D627374S

(12) **United States Design Patent**
Yang

(10) **Patent No.:** **US D627,374 S**

(45) **Date of Patent:** **** Nov. 16, 2010**

(54) **REFRIGERATOR FOR WINES**

(75) Inventor: **Yun Ho Yang**, Seoul (KR)

(73) Assignee: **Samsung Electronics Co., Ltd.**, Suwon (KR)

(**) Term: **14 Years**

(21) Appl. No.: **29/340,388**

(22) Filed: **Jul. 17, 2009**

(51) **LOC (9) Cl.** **15-07**

(52) **U.S. Cl.** **D15/81**

(58) **Field of Classification Search** D15/79,
D15/81, 85, 86, 88; D6/329, 396, 437, 470-474;
62/246-255, 337, 440-449; 312/114, 116,
312/236, 352, 400-408

See application file for complete search history.

(56) **References Cited**

U.S. PATENT DOCUMENTS

- 5,848,534 A * 12/1998 Stauffer 312/404
- D467,596 S * 12/2002 Kim et al. D15/81
- D478,601 S * 8/2003 Becke D15/81

- D493,181 S * 7/2004 Kehoe D15/81
- D512,081 S * 11/2005 Chang D15/81
- D571,157 S * 6/2008 Chan et al. D15/81
- D604,340 S * 11/2009 Kim et al. D15/81

* cited by examiner

Primary Examiner—Shanda C Hill

(74) *Attorney, Agent, or Firm*—Ladas & Parry LLP

(57) **CLAIM**

The ornamental design for a refrigerator for wines, as shown and described.

DESCRIPTION

FIG. 1 is a front, right, top perspective view of a refrigerator for wines showing my new design;

FIG. 2 is a front elevational view thereof;

FIG. 3 is a rear elevational view thereof;

FIG. 4 is a left side elevational view thereof;

FIG. 5 is right side elevational view thereof;

FIG. 6 is a top plan view thereof; and,

FIG. 7 is a bottom plan view thereof.

1 Claim, 6 Drawing Sheets

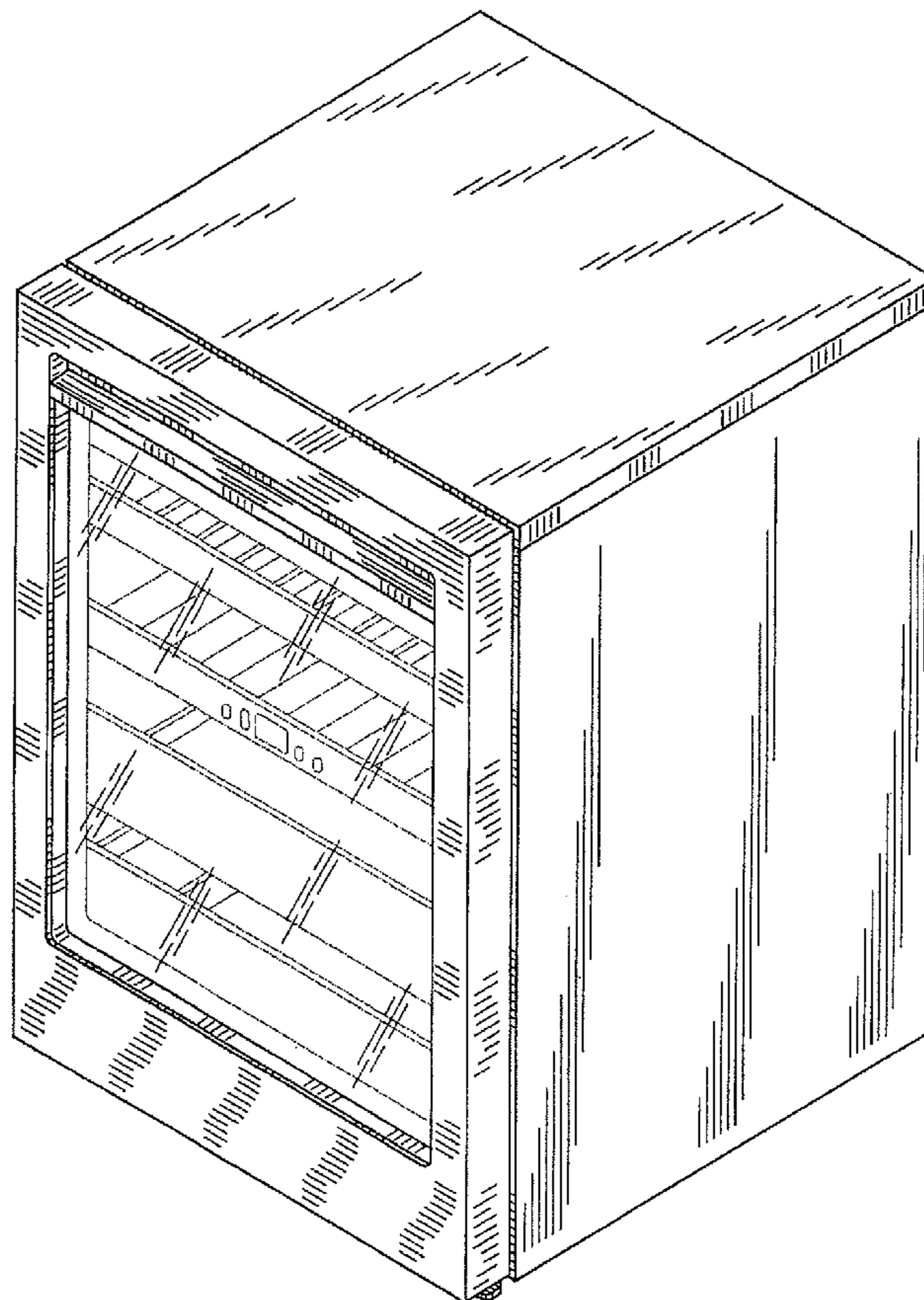

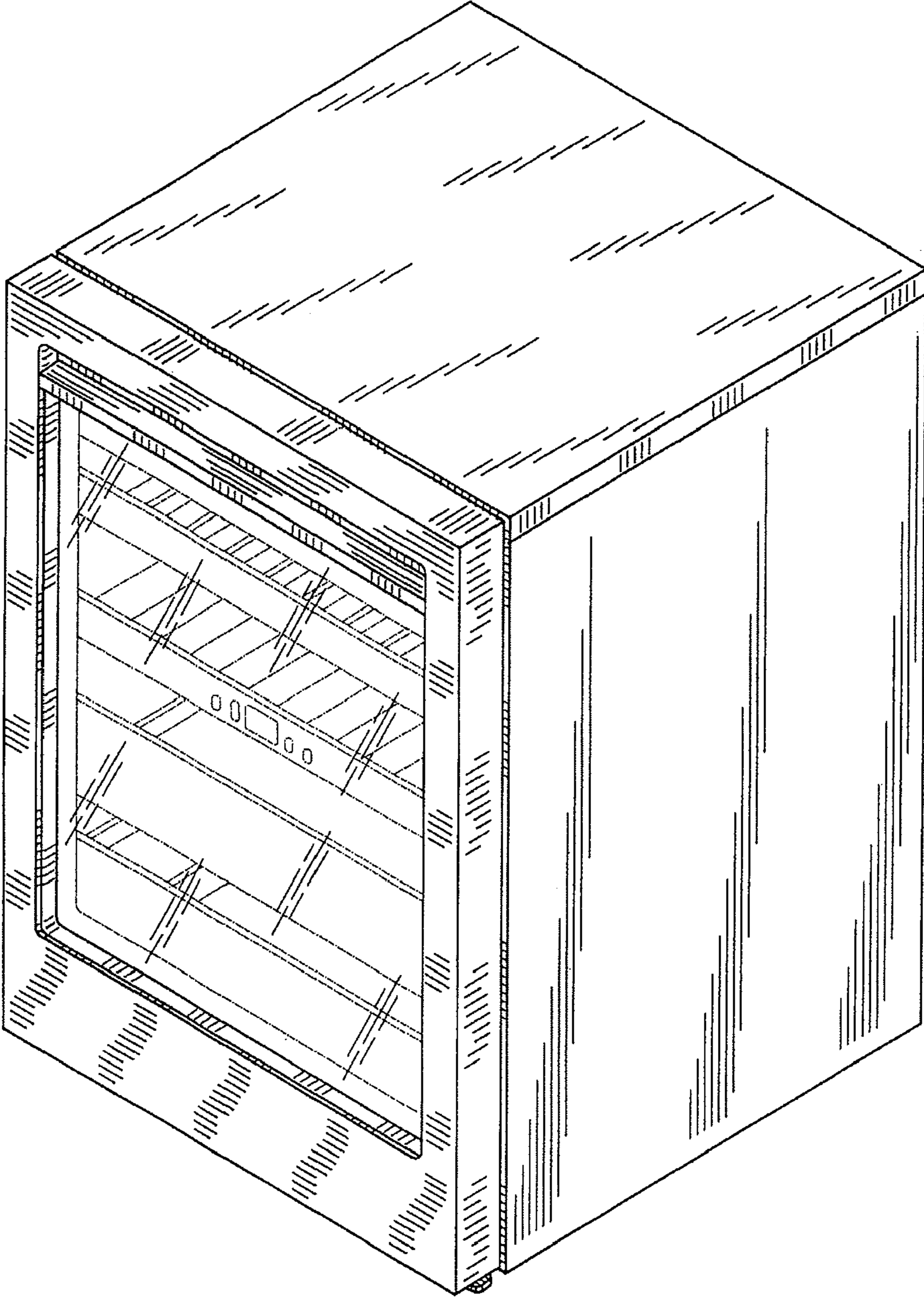

FIG. 1

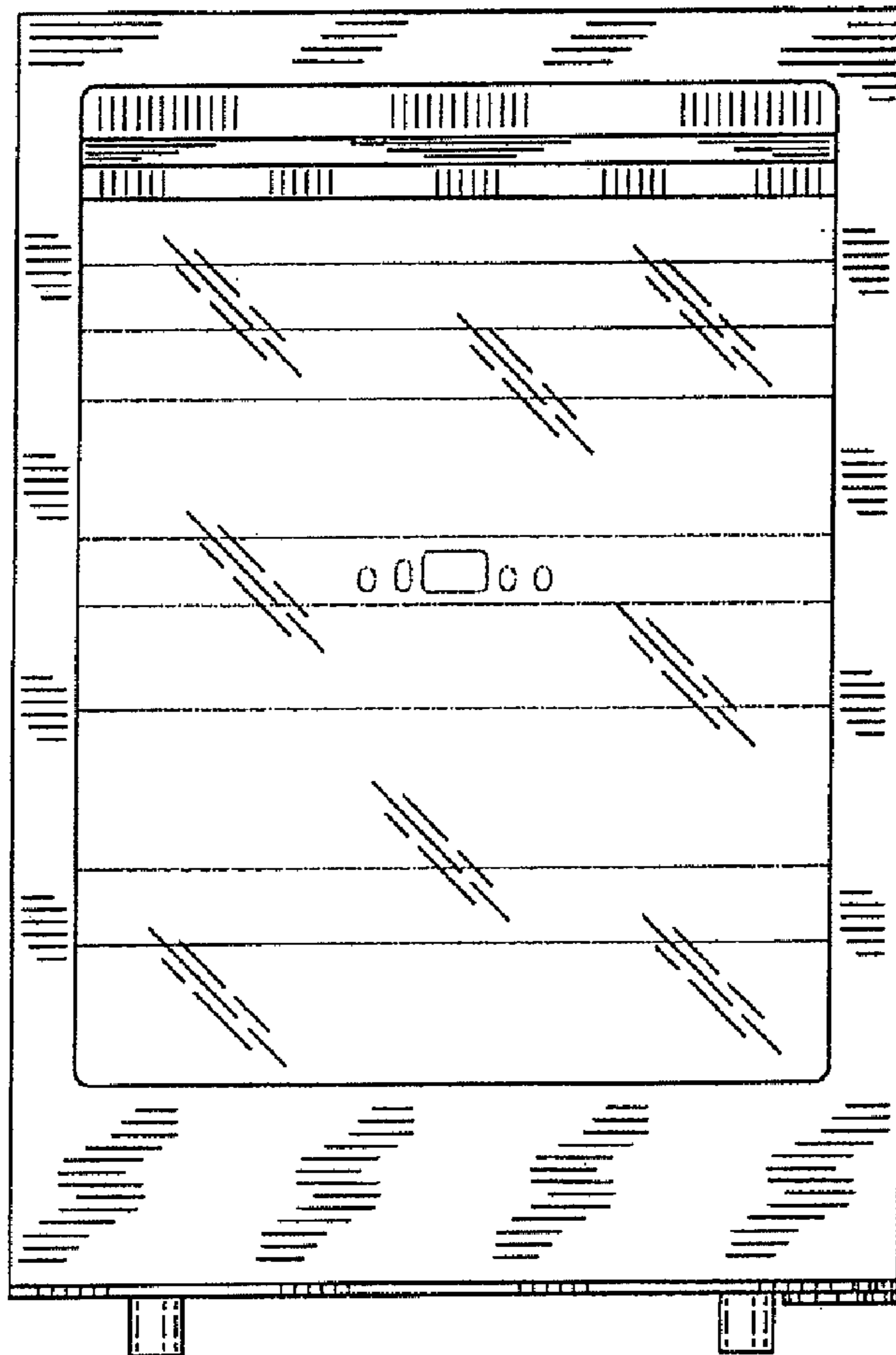

FIG. 2

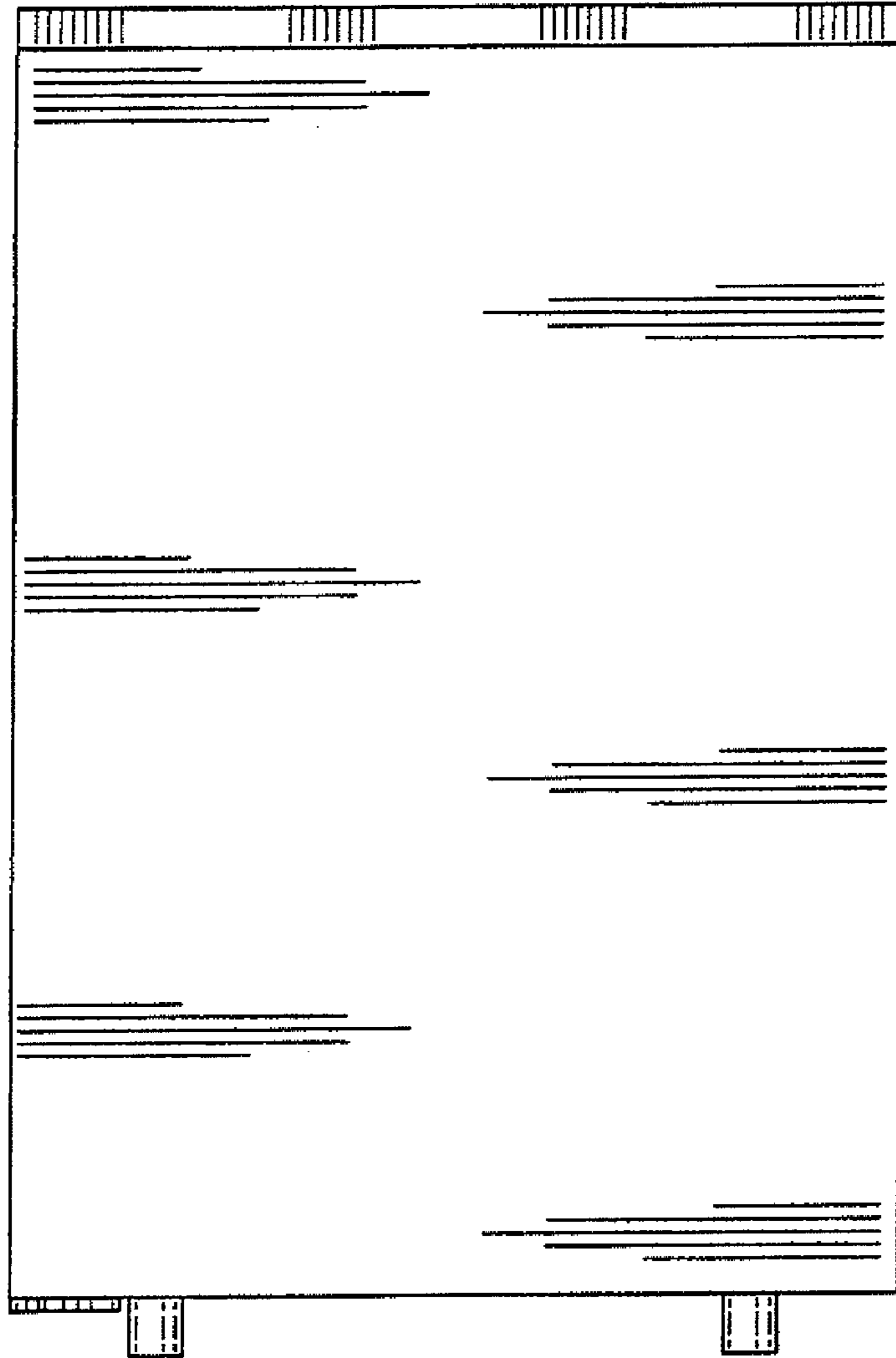

FIG. 3

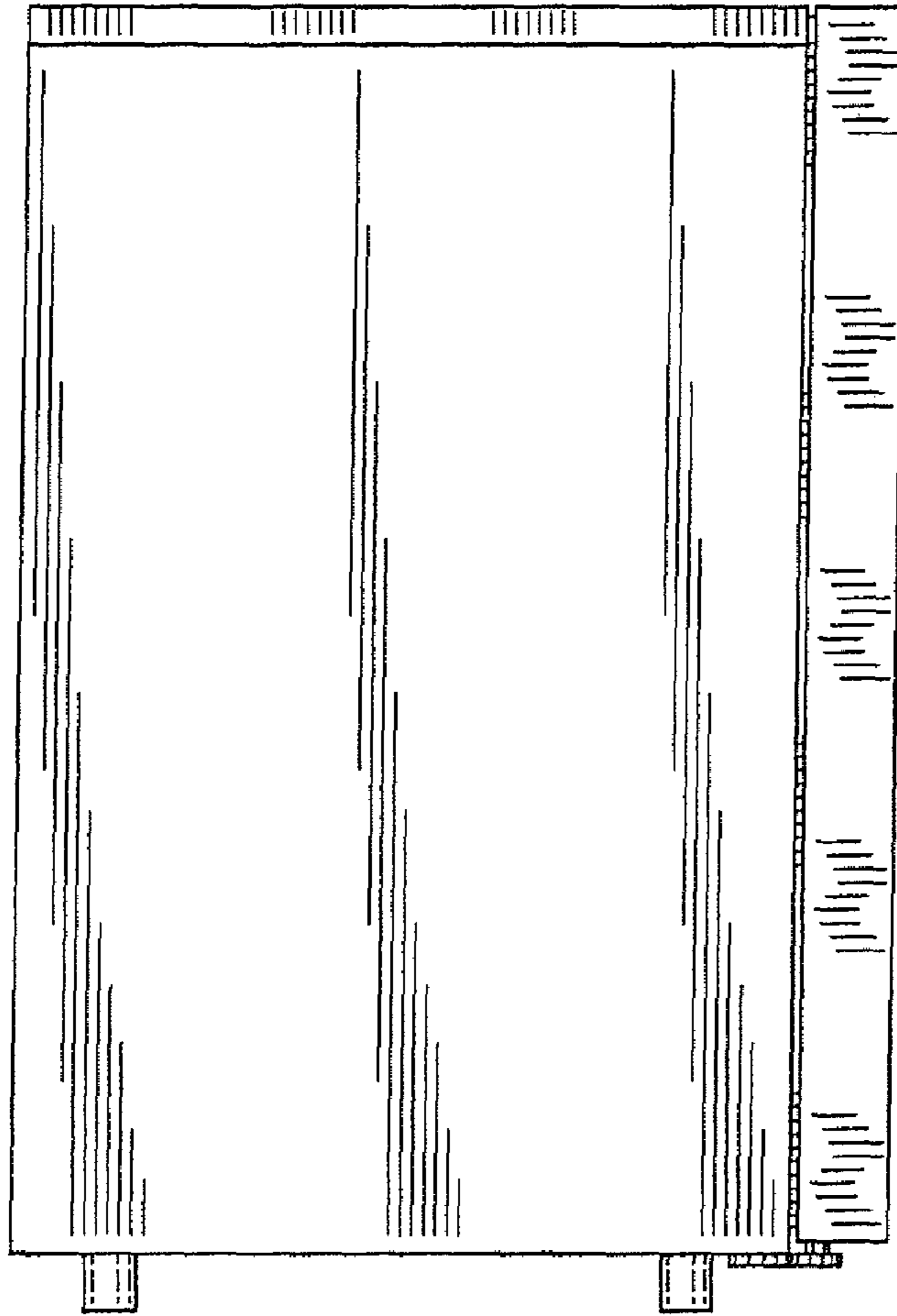

FIG. 4

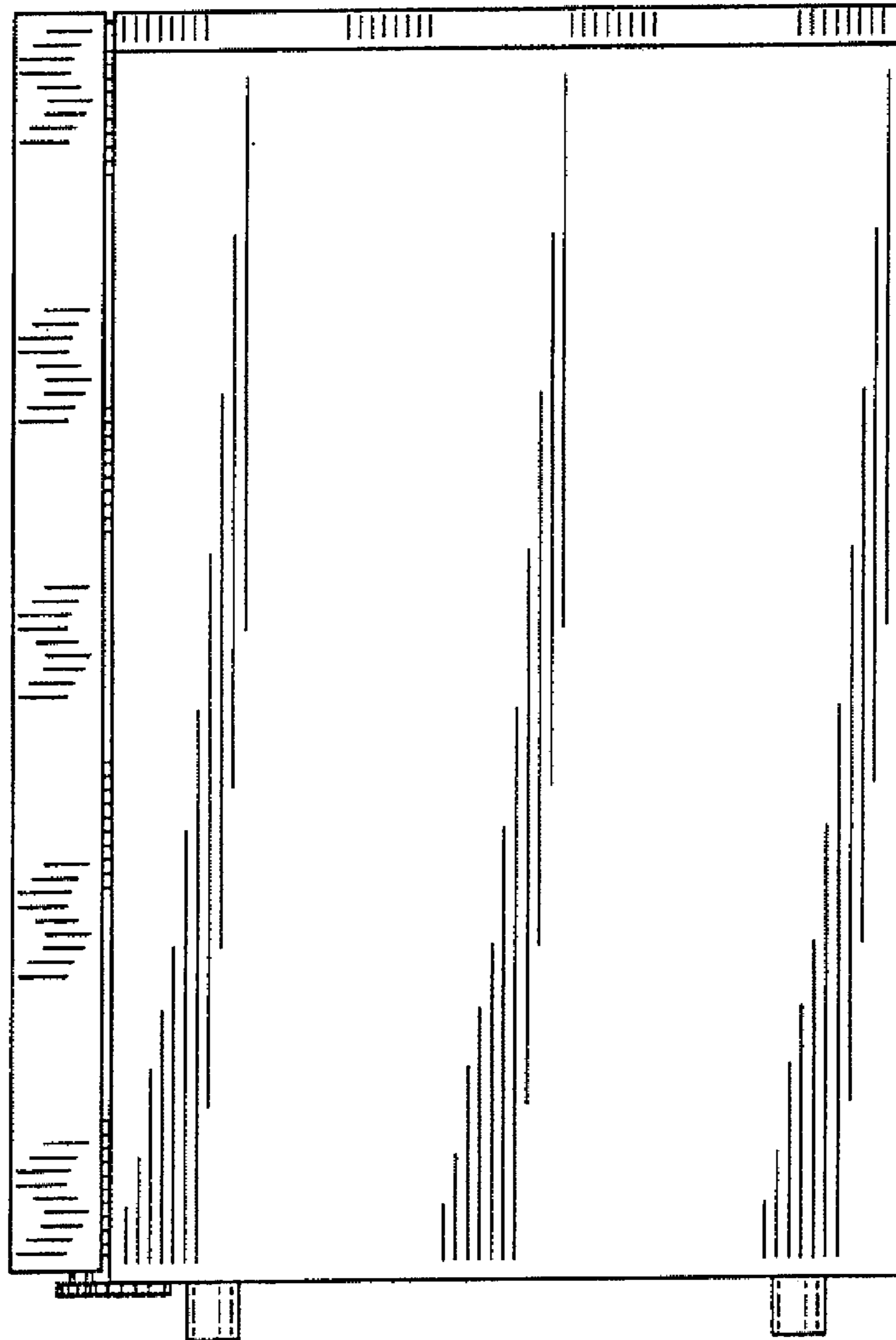

FIG. 5

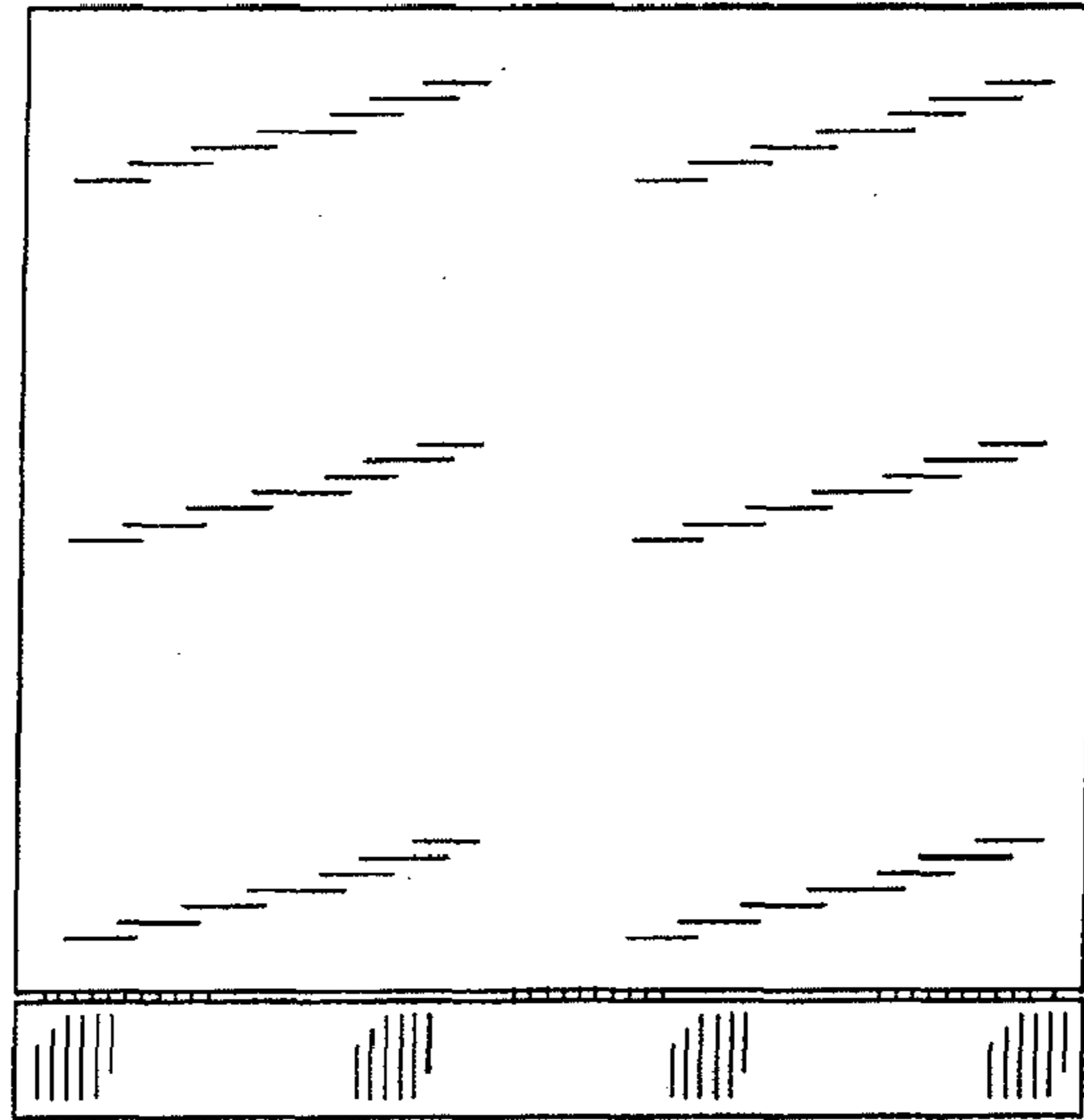

FIG. 6

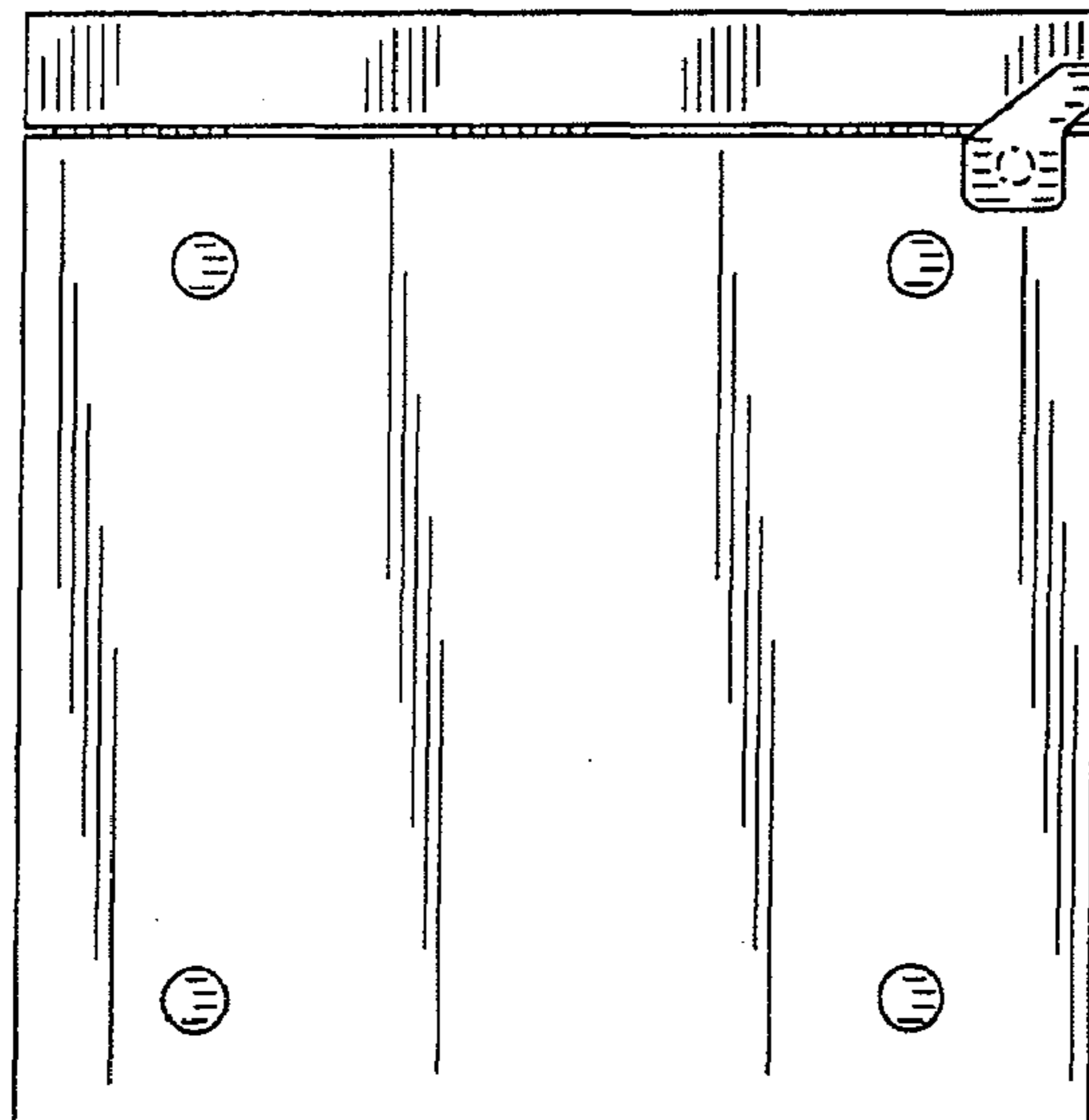

FIG. 7