



US00D627327S

(12) **United States Design Patent**  
**Zuffo et al.**

(10) **Patent No.:** **US D627,327 S**  
(45) **Date of Patent:** **\*\* Nov. 16, 2010**

(54) **COMMUNICATION DEVICE**

(75) Inventors: **Marcello Zuffo**, Fort Lauderdale, FL (US); **Ryan M. Nilsen**, Pompano, FL (US); **William H. Robertson, Jr.**, Fort Lauderdale, FL (US); **Claudio Santiago Ribeiro**, Evanston, IL (US)

(73) Assignee: **Motorola Mobility, Inc.**, Libertyville, IL (US)

(\*\*) Term: **14 Years**

(21) Appl. No.: **29/354,585**

(22) Filed: **Jan. 26, 2010**

(51) **LOC (9) Cl.** ..... **14-03**

(52) **U.S. Cl.** ..... **D14/138 AB**

(58) **Field of Classification Search** ..... D14/138 AB,  
D14/496, 341, 345, 346, 203.3, 203.4, 203.7;  
455/575.3; D21/517; 379/433.13  
See application file for complete search history.

(56) **References Cited**

**U.S. PATENT DOCUMENTS**

D519,098 S *	4/2006	Han et al.	.....	D14/138 AB
D519,967 S	5/2006	Wei et al.		
D546,312 S *	7/2007	Han et al.	.....	D14/138 AB
D552,055 S *	10/2007	Lheem	.....	D14/138 AB

(Continued)

**OTHER PUBLICATIONS**

LG M4410 telephone, announced 1<sup>st</sup> quarter 2005, [online], [site visited Jun. 18, 2010]. Available from Internet, <URL: <http://www.gsmarena.com>>.\*

(Continued)

*Primary Examiner*—Jeffrey D Asch

(57) **CLAIM**

The ornamental design for a communication device, as shown and described.

**DESCRIPTION**

FIG. 1 is a front perspective view of a first embodiment of an ornamental design for a communication device;

FIG. 2 is a front view of the first embodiment thereof;

FIG. 3 is a rear view of the first embodiment thereof;

FIG. 4 is first side view of the first embodiment thereof;

FIG. 5 is a second side view of the first embodiment thereof;

FIG. 6 is a top view of the first embodiment thereof; and

FIG. 7 is a bottom view of the first embodiment thereof.

FIG. 8 is a front perspective view of a second embodiment of an ornamental design for a communication device;

FIG. 9 is a front view of the second embodiment thereof;

FIG. 10 is a rear view of the second embodiment thereof;

FIG. 11 is a first side view of the second embodiment thereof;

FIG. 12 is a second side view of the second embodiment thereof;

FIG. 13 is a top view of the second embodiment thereof; and,

FIG. 14 is a bottom view of the second embodiment thereof.

The broken lines shown in FIGS. 1-7 that are immediately adjacent to the shaded areas, and define unshaded regions, represent the bounds of the first embodiment, while all other broken lines are directed to environment and are for illustrative purposes only; the broken lines form no part of the first embodiment.

**1 Claim, 8 Drawing Sheets**

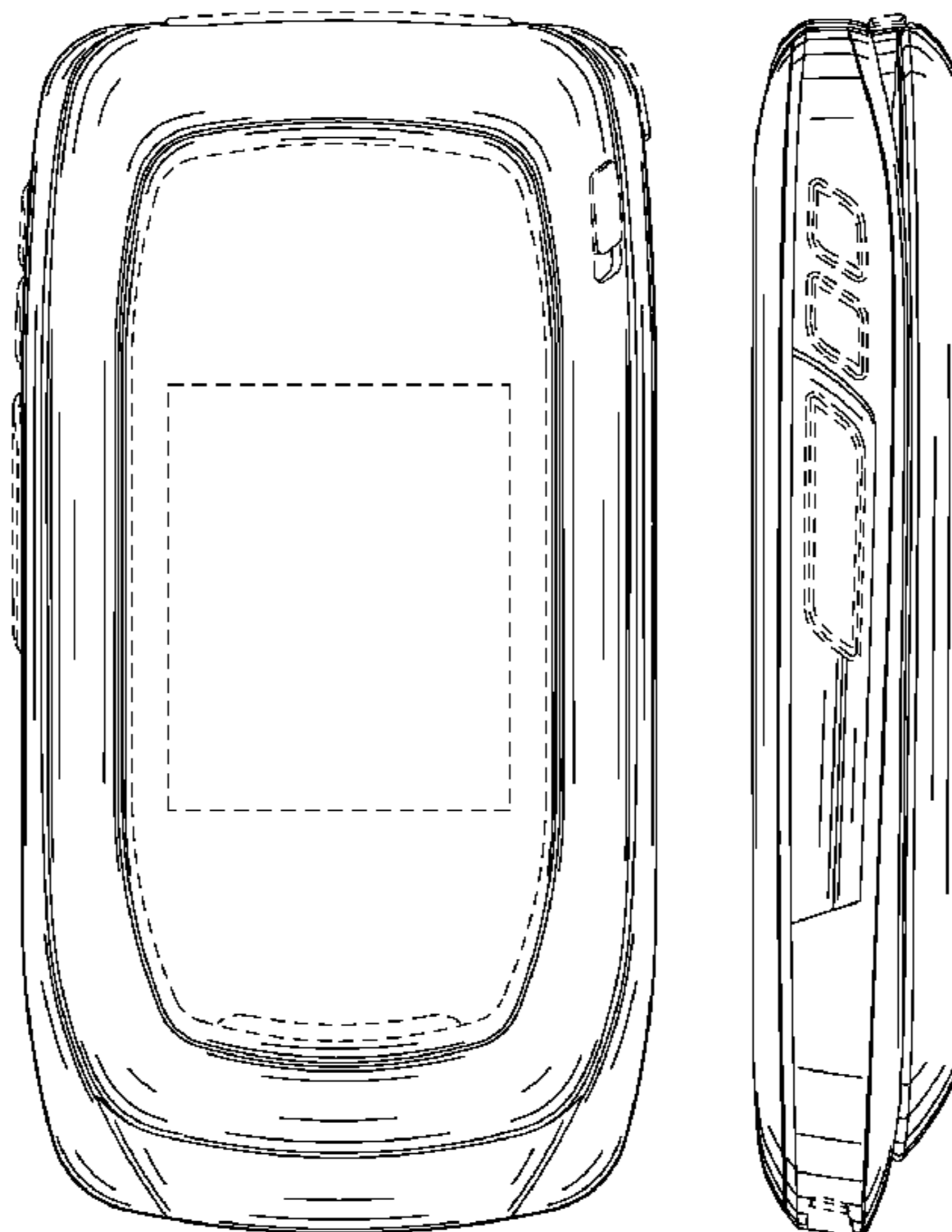

# US D627,327 S

Page 2

## U.S. PATENT DOCUMENTS

D556,716 S \* 12/2007 Park et al. .... D14/138 AB  
D557,233 S \* 12/2007 Kim et al. .... D14/138 AB  
D561,159 S 2/2008 Heng et al.  
D569,825 S \* 5/2008 Kim et al. .... D14/138 AB  
D570,813 S \* 6/2008 Song et al. .... D14/138 AB  
D572,691 S \* 7/2008 Song et al. .... D14/138 AB  
D574,804 S \* 8/2008 Kim et al. .... D14/138 AB  
D578,498 S \* 10/2008 Choi et al. .... D14/138 AB  
D582,871 S \* 12/2008 Chung et al. .... D14/138 AB  
D582,879 S \* 12/2008 Chung et al. .... D14/138 AB  
7,467,000 B2 \* 12/2008 Shiba ..... 455/575.8  
D584,265 S \* 1/2009 Lee et al. .... D14/138 AB  
D588,572 S \* 3/2009 Park et al. .... D14/138 AB  
7,512,428 B2 \* 3/2009 An et al. .... 455/575.3  
D593,064 S \* 5/2009 Sutherland et al. ... D14/138 AB  
D593,521 S \* 6/2009 Tan ..... D14/138 AB  
D593,523 S 6/2009 Neumann et al.  
D593,524 S \* 6/2009 Neumann et al. .... D14/138 AB  
D593,981 S \* 6/2009 Boucquey et al. .... D14/138 AB  
D593,985 S \* 6/2009 Park et al. .... D14/138 AB  
D604,262 S \* 11/2009 Lee ..... D14/138 AB

D606,508 S \* 12/2009 Wun et al. .... D14/138 AB  
D616,846 S \* 6/2010 Byun et al. .... D14/138 AB  
2007/0178949 A1 \* 8/2007 Sato et al. .... 455/575.3

## OTHER PUBLICATIONS

LG F3000 telephone, announced 3rd quarter 2005, [online], [site visited Jun. 18, 2010]. Available from Internet ,<URL: <http://www.gsmarena.com>>.\*

Motorola EM28 telephone, announced Aug. 2008, [online], [site visited Jun. 18, 2010]. Available from Internet ,<URL: <http://www.gsmarena.com>>.\*

Nokia 6126 telephone, announced Feb. 2006, [online], [site visited Jun. 18, 2010]. Available from Internet ,<URL: <http://www.gsmarena.com>>.\*

Samsung Z330 telephone, announced Feb. 2006, [online], [site visited Jun. 18, 2010]. Available from Internet ,<URL: <http://www.gsmarena.com>>.\*

Samsung A237 telephone, announced Oct. 2008, [online], [site visited Jun. 18, 2010]. Available from Internet ,<URL: <http://www.gsmarena.com>>.\*

\* cited by examiner

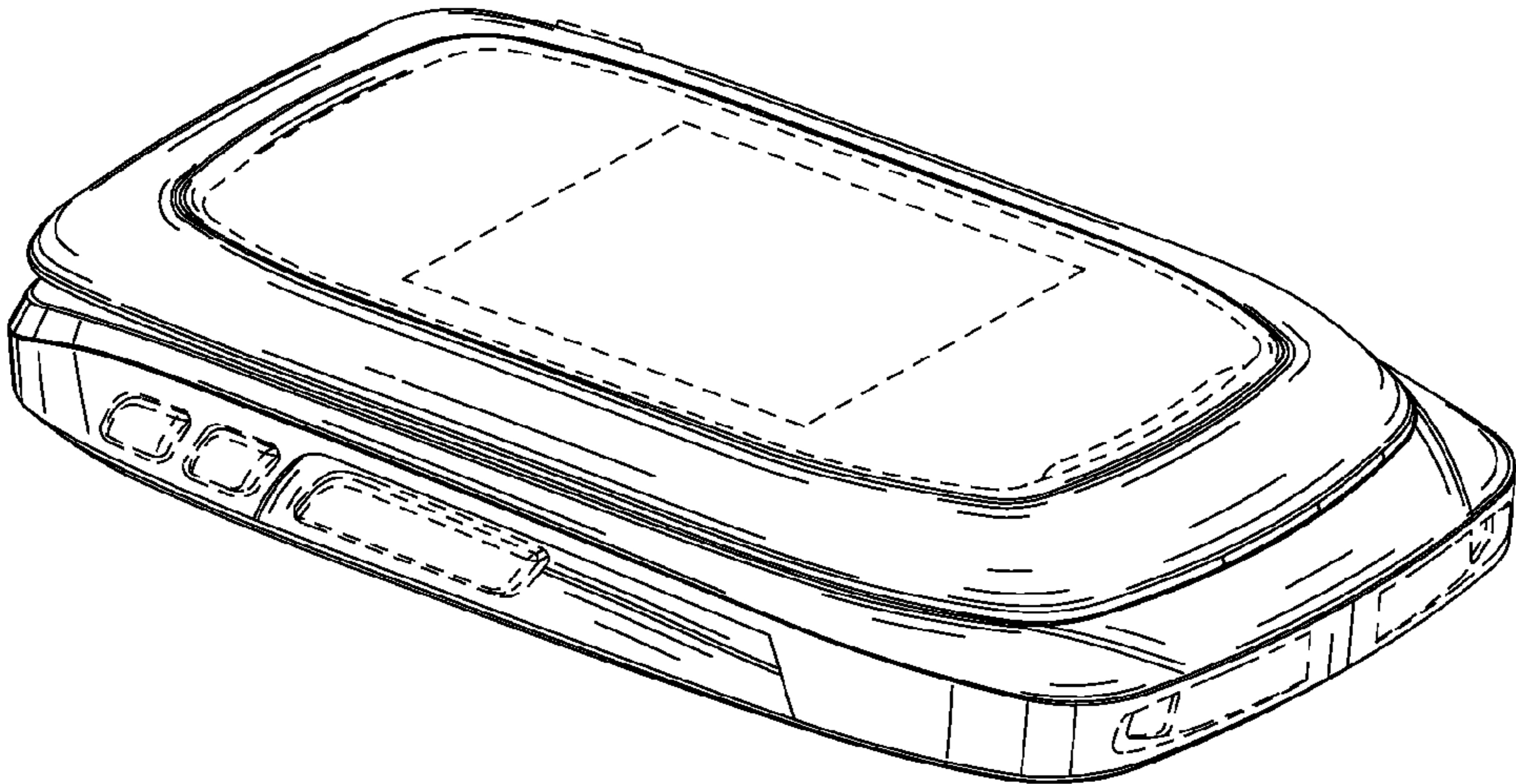

FIG. 1

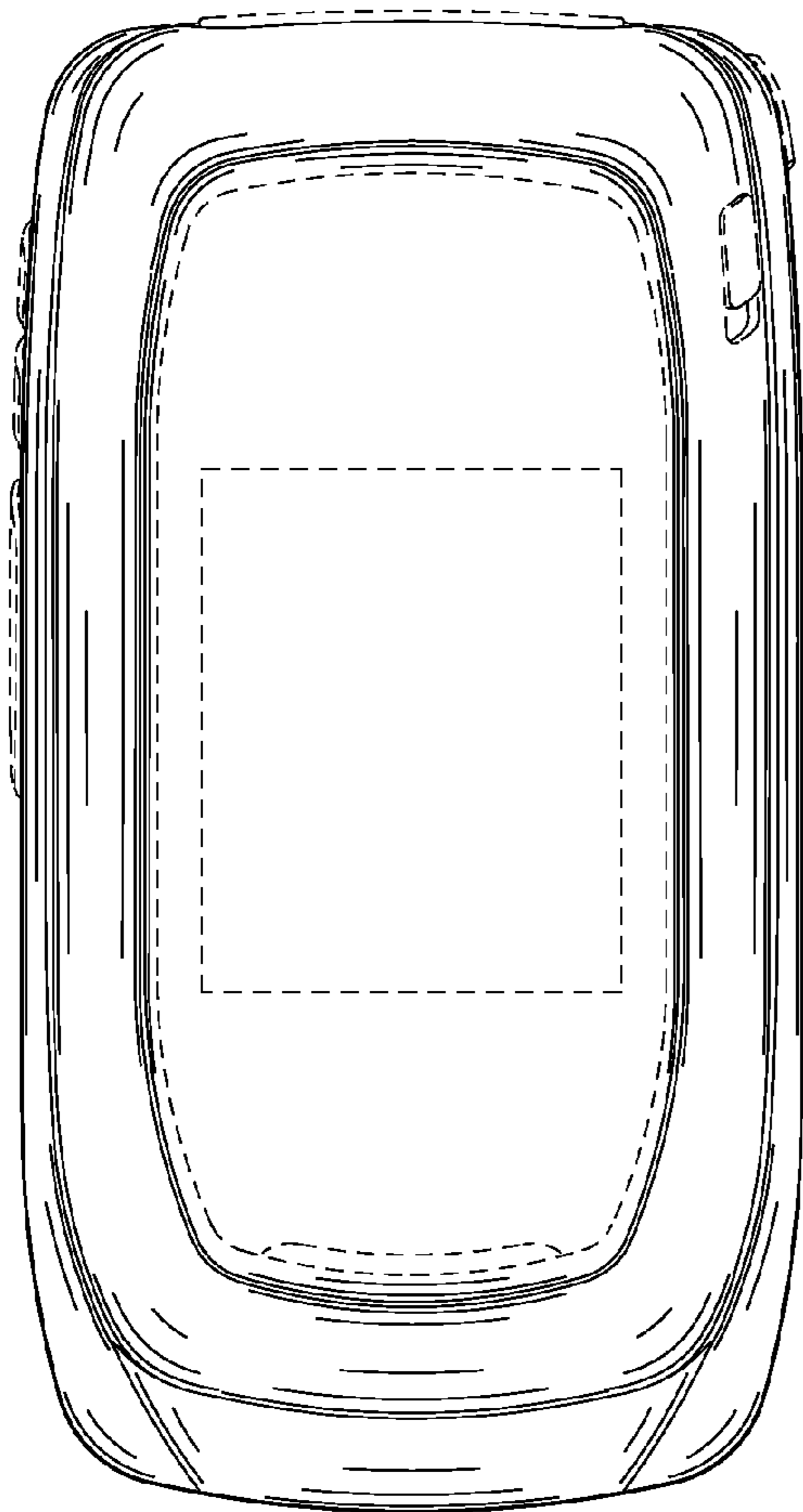

FIG. 2

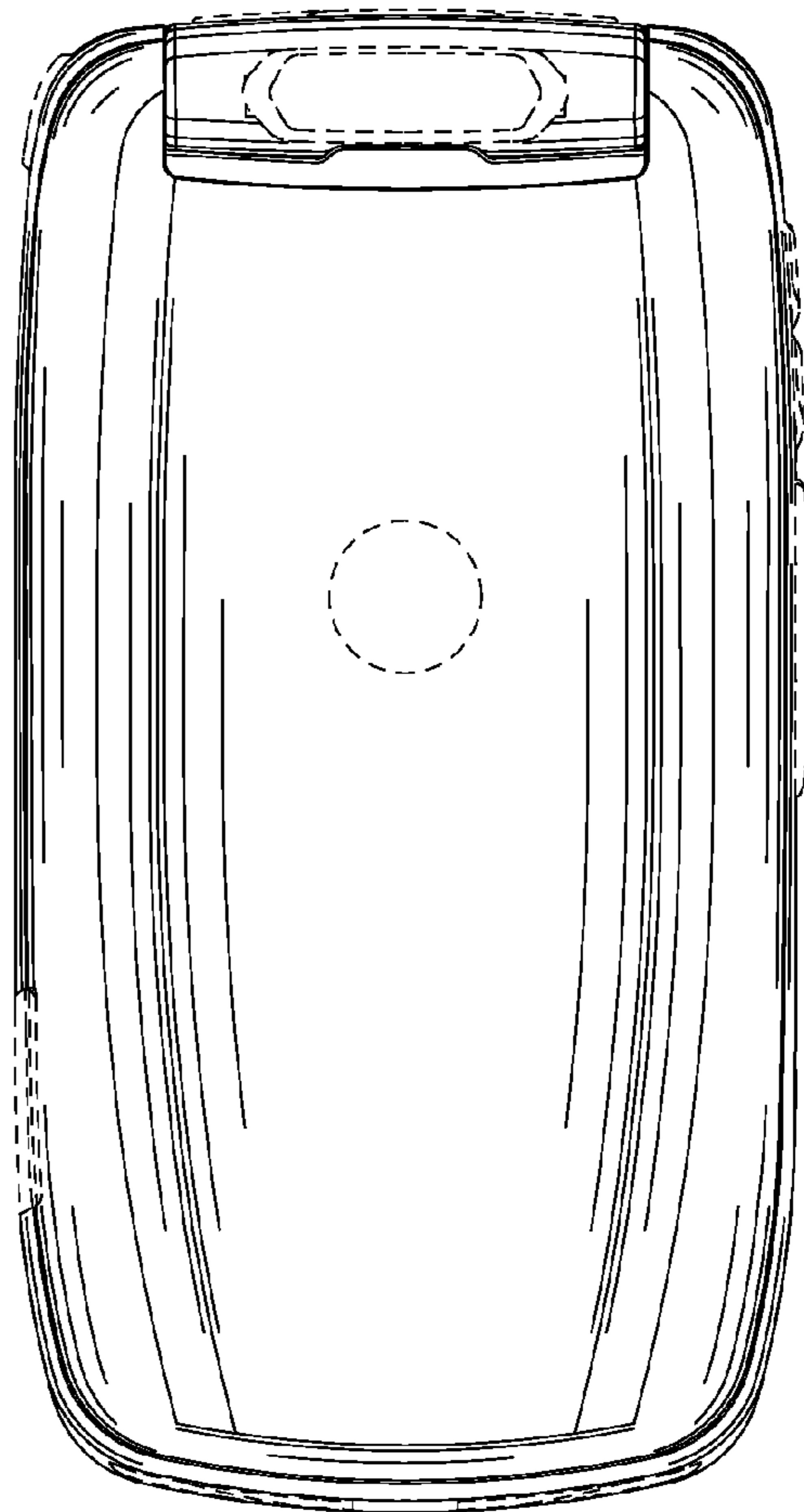

FIG. 3

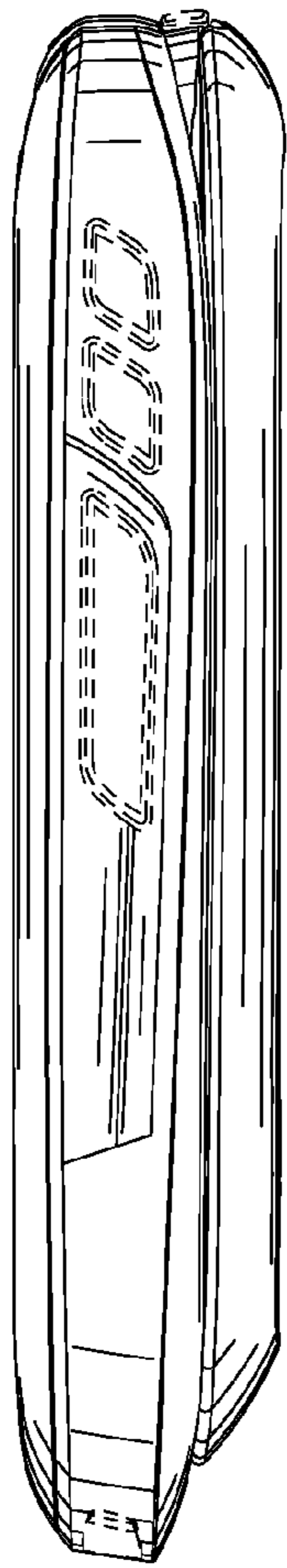

FIG. 4

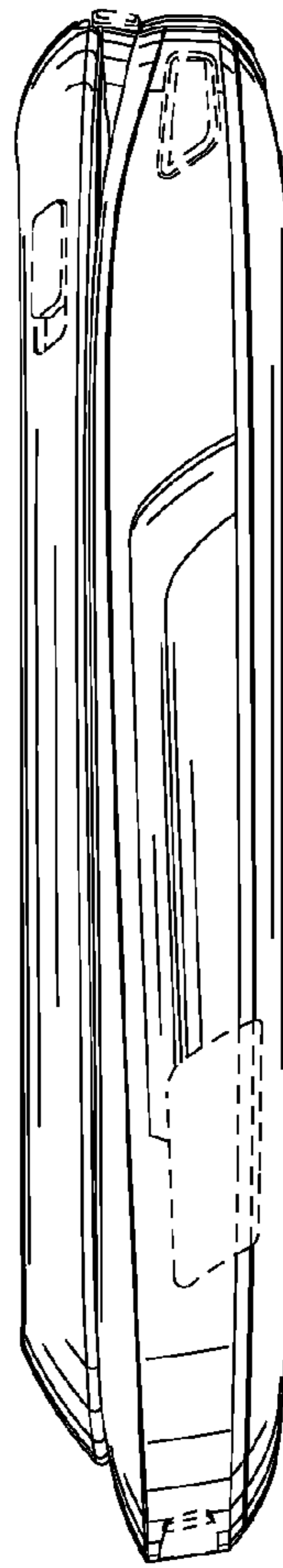

FIG. 5

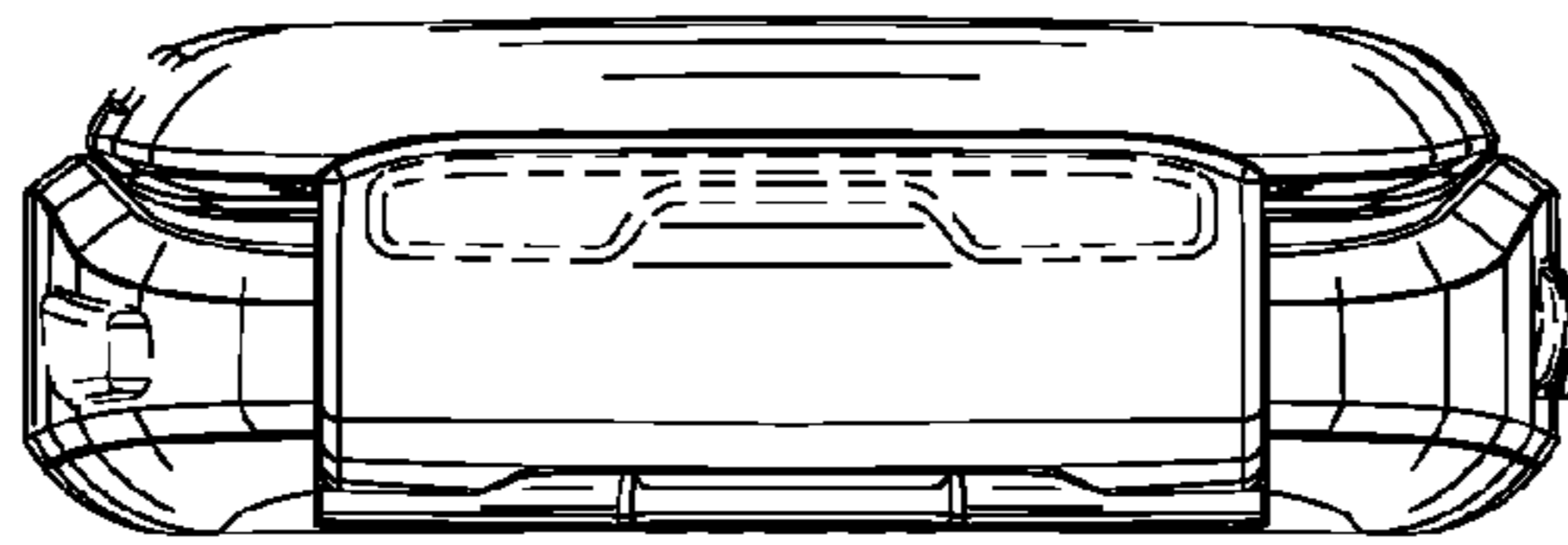

FIG. 6

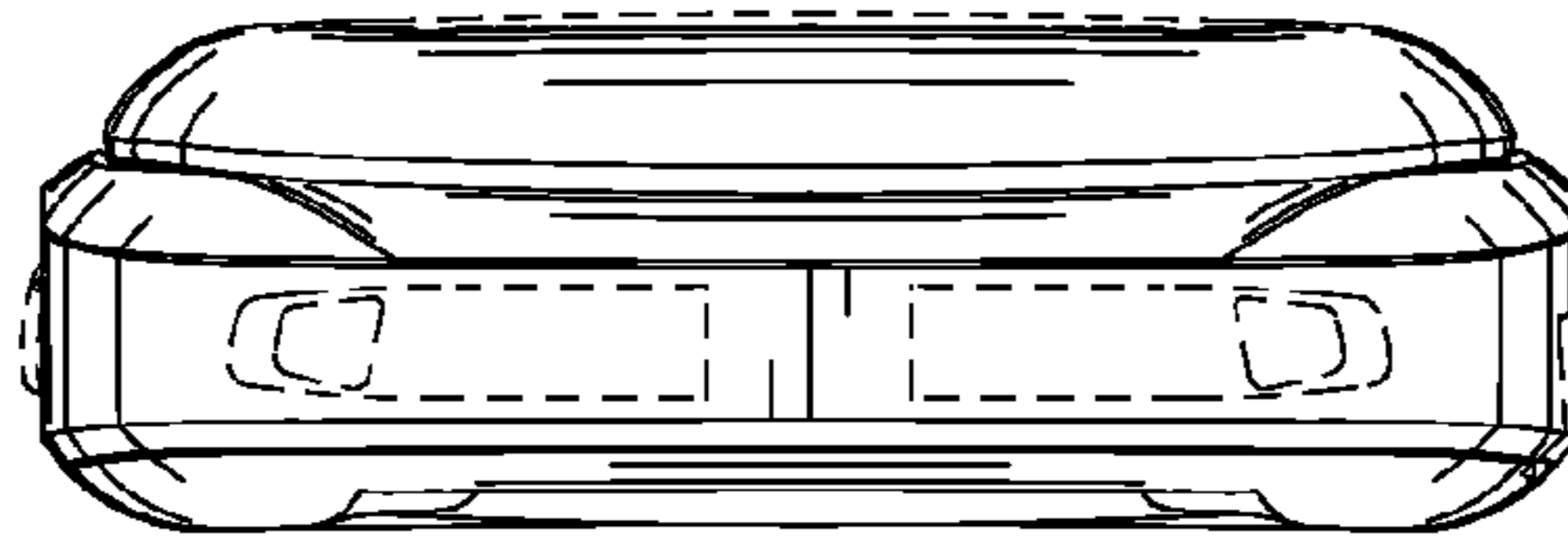

FIG. 7

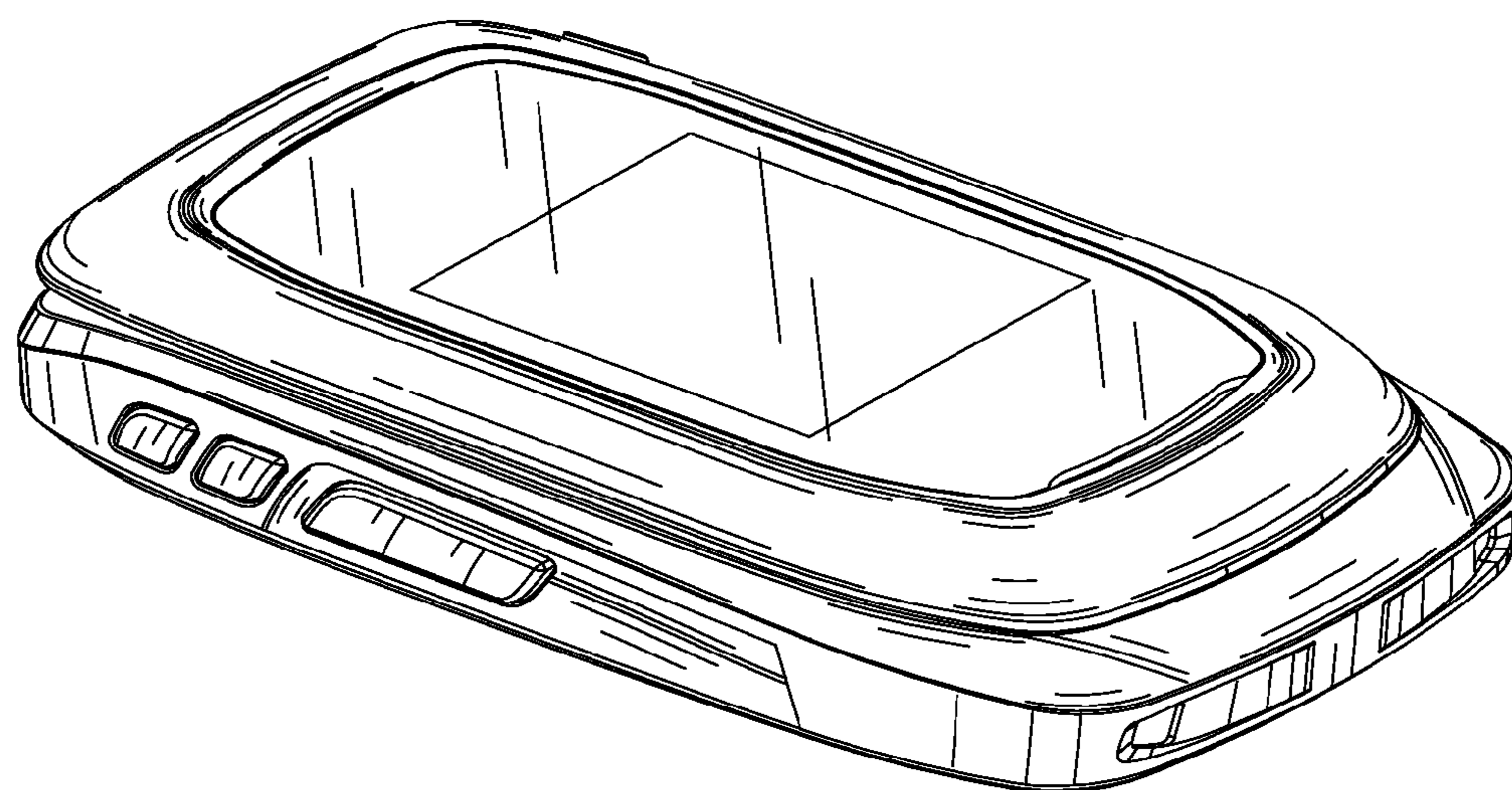

FIG. 8

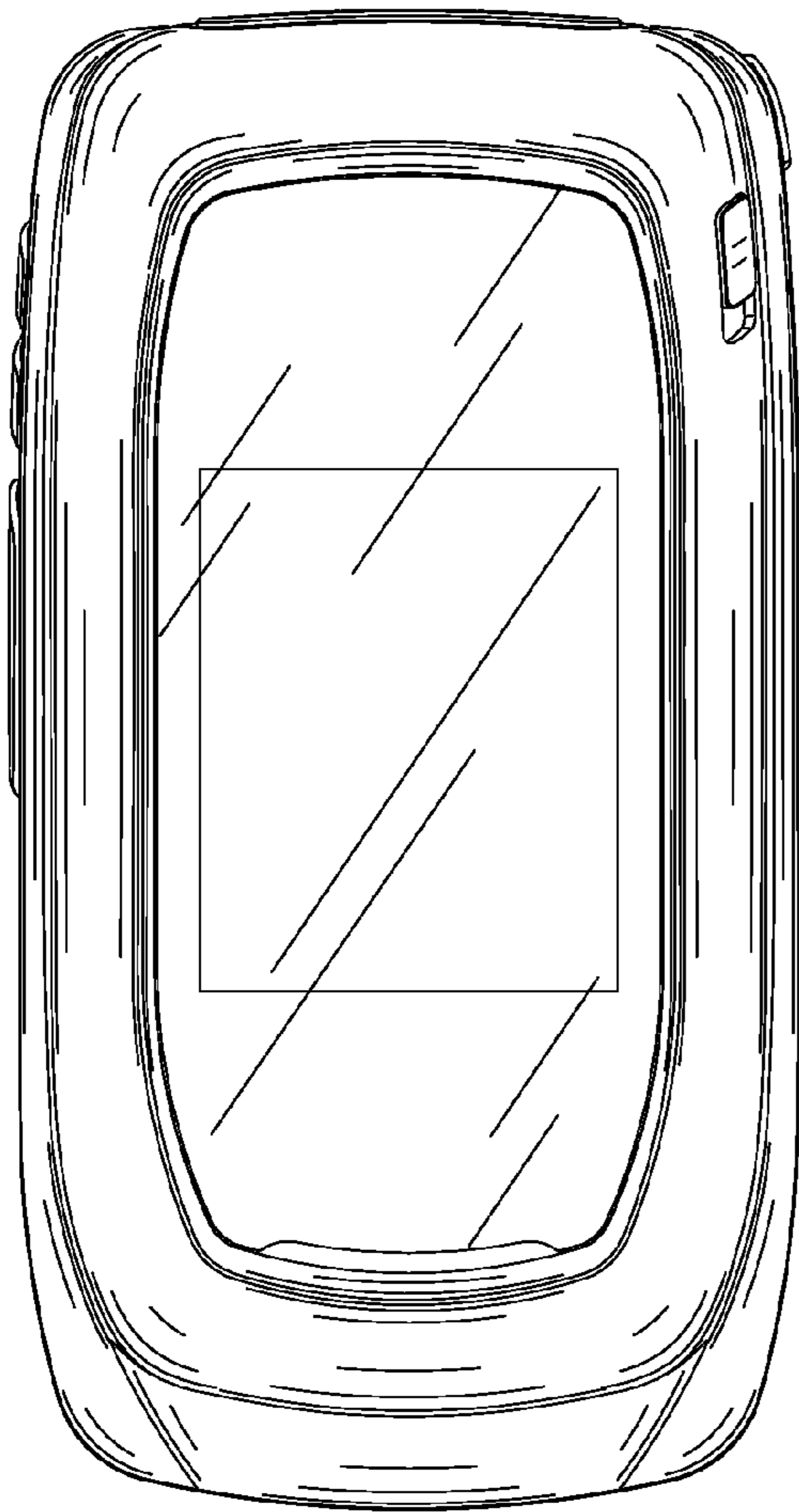

FIG. 9

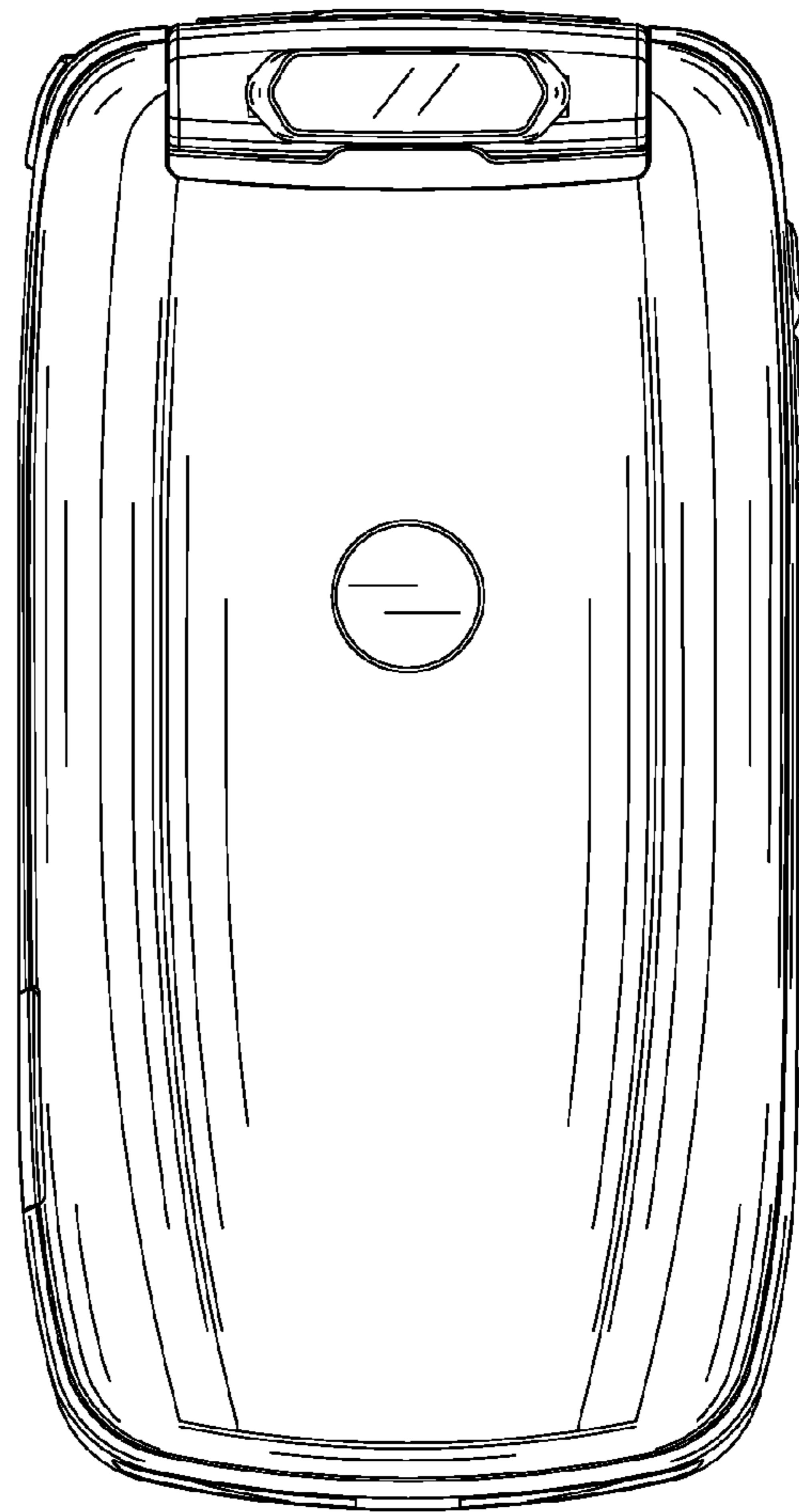

FIG. 10



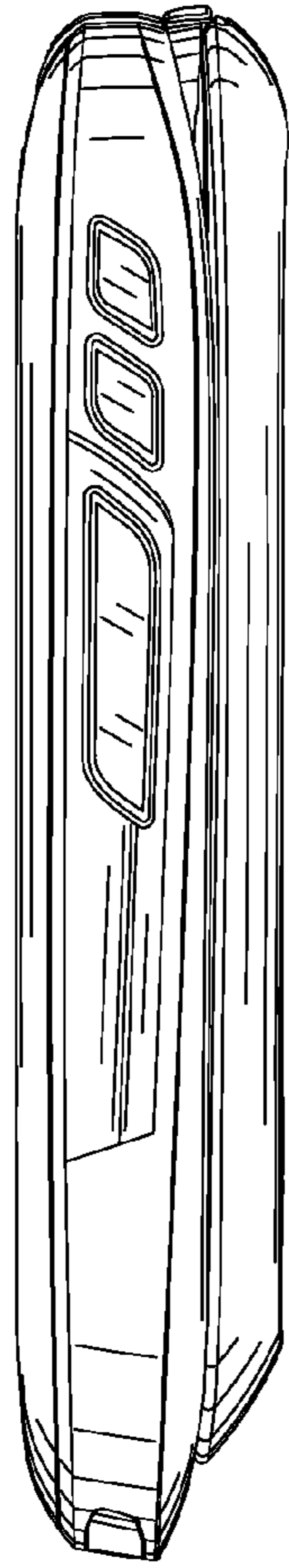

FIG. 11

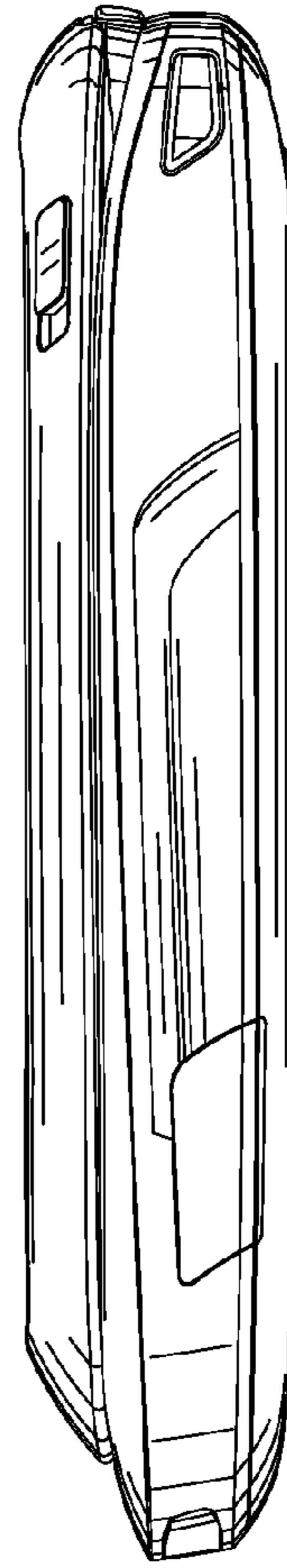

FIG. 12

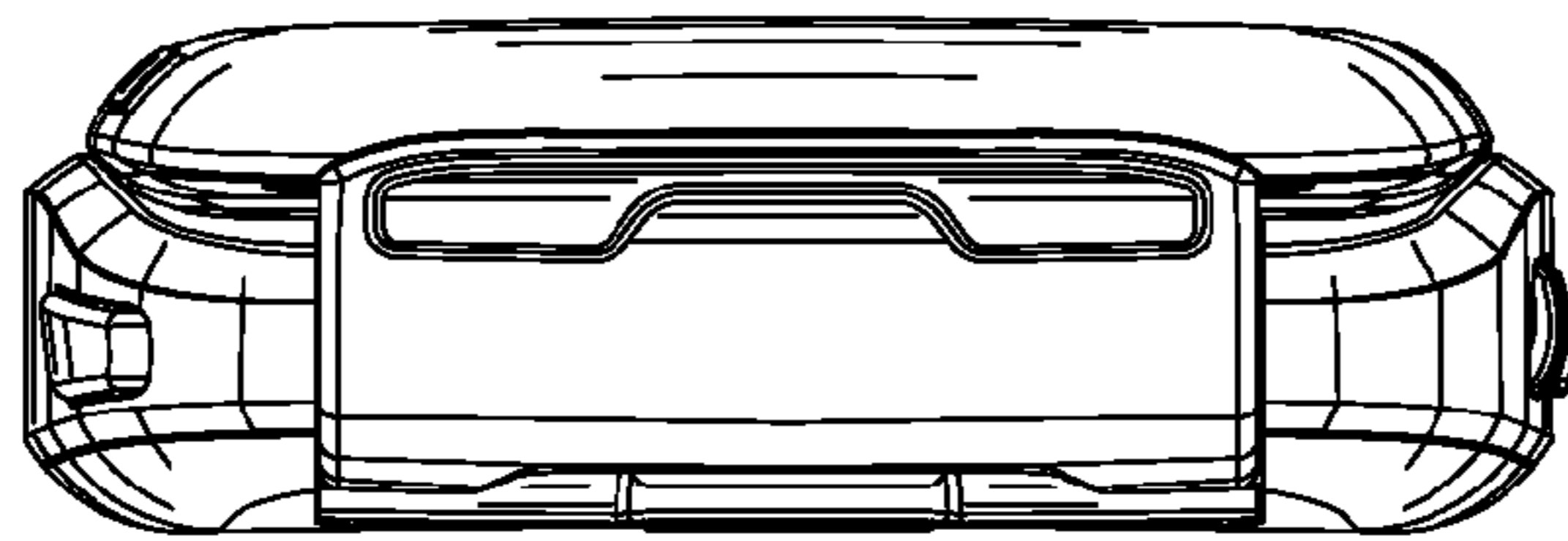

FIG. 13

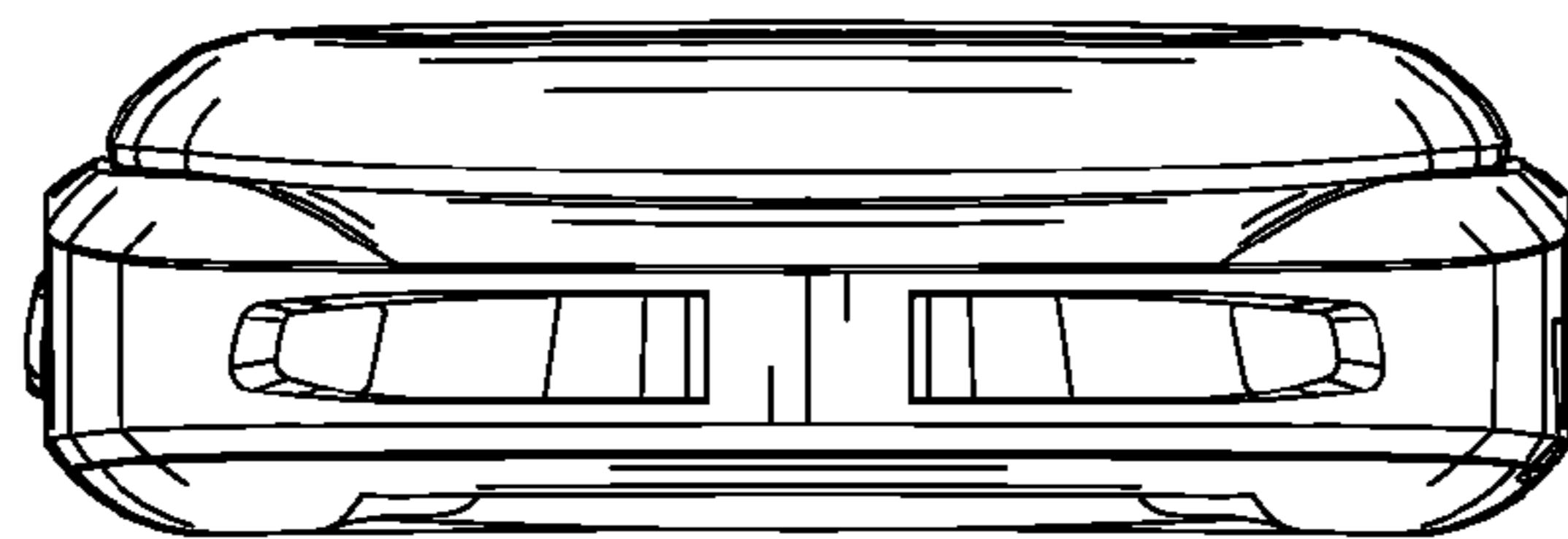

FIG. 14