



US00D627325S

(12) **United States Design Patent**
Zhang et al.

(10) **Patent No.:** **US D627,325 S**
(45) **Date of Patent:** **** Nov. 16, 2010**

(54) **COMMUNICATION DEVICE**

- (75) Inventors: **Wei Zhang**, Beijing (CN); **Ruben D Castano**, Glenview, IL (US); **Fu-Yuan Hsu**, Beijing (CN)
- (73) Assignee: **Motorola Mobility, Inc.**, Libertyville, IL (US)
- (**) Term: **14 Years**
- (21) Appl. No.: **29/350,795**
- (22) Filed: **Nov. 24, 2009**
- (51) **LOC (9) Cl.** **14-03**
- (52) **U.S. Cl.** **D14/138 AB**
- (58) **Field of Classification Search** D14/138 AB,
D14/496, 341, 345, 346, 203.3, 203.4, 203.7;
455/575.3; D21/517; 379/433.13
See application file for complete search history.

(56) **References Cited**

U.S. PATENT DOCUMENTS

- D502,701 S * 3/2005 Takuma D14/345
- D573,569 S * 7/2008 Arnholt et al. D14/138 AB
- D576,600 S * 9/2008 Kim et al. D14/138 AB
- D578,501 S * 10/2008 Seo et al. D14/138 AB

(Continued)

OTHER PUBLICATIONS

Motorola A1800 telephone, announced Jun. 2008, [online], [site visited Jun. 18, 2010]. Available from Internet ,<URL: <http://www.gsmarena.com>>.*

(Continued)

Primary Examiner—Jeffrey D Asch

(57) **CLAIM**

The ornamental design for a communication device, as shown and described.

DESCRIPTION

FIG. 1 is a front perspective view of a first embodiment of an ornamental design for a communication device;

FIG. 2 is a rear perspective view of the first embodiment thereof;

FIG. 3 is a front view of the first embodiment thereof;

FIG. 4 is a rear view of the first embodiment thereof;

FIG. 5 is a first side view of the first embodiment thereof;

FIG. 6 is a second side view of the first embodiment thereof;

FIG. 7 is a top view of the first embodiment thereof; and

FIG. 8 is a bottom view of the first embodiment thereof.

FIG. 9 is a front perspective view of a second embodiment of an ornamental design for a communication device;

FIG. 10 is a rear perspective view of the second embodiment thereof;

FIG. 11 is a front view of the second embodiment thereof;

FIG. 12 is a rear view of the second embodiment thereof;

FIG. 13 is a first side view of the second embodiment thereof;

FIG. 14 is a second side view of the second embodiment thereof;

FIG. 15 is a top view of the second embodiment thereof; and

FIG. 16 is a bottom view of the second embodiment thereof.

The broken lines shown in FIGS. 1-8 that are immediately adjacent to the shaded areas, and define unshaded regions, represent the bounds of the first embodiment, while all other broken lines are directed to environment and are for illustrative purposes only; the broken lines form no part of the first embodiment.

1 Claim, 10 Drawing Sheets

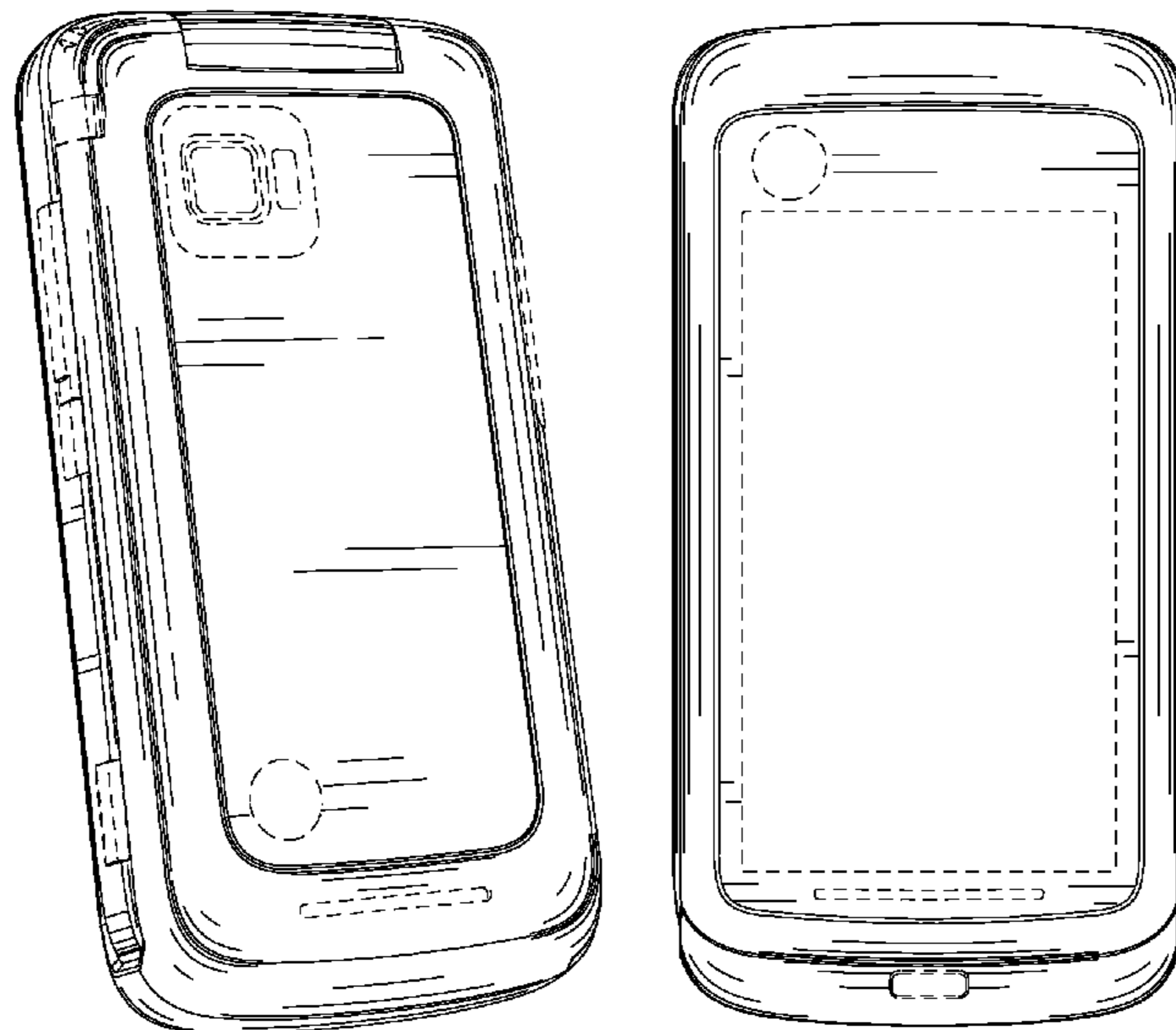

US D627,325 S

Page 2

U.S. PATENT DOCUMENTS

D582,879 S * 12/2008 Chung et al. D14/138 AB
D588,572 S * 3/2009 Park et al. D14/138 AB
D589,024 S * 3/2009 Yoo D14/138 AB
7,512,428 B2 * 3/2009 An et al. 455/575.3
D591,260 S * 4/2009 Kim et al. D14/138 AB
D593,053 S * 5/2009 Kim et al. D14/138 AB
D593,981 S * 6/2009 Boucquey et al. D14/138 AB
D594,435 S * 6/2009 Chambers D14/138 AB
D601,108 S * 9/2009 Boucquey et al. D14/138 AB
D602,896 S * 10/2009 Finney et al. D14/138 AB
D602,897 S * 10/2009 Finney et al. D14/138 AB
D603,354 S * 11/2009 Kim et al. D14/138 AB
D603,364 S * 11/2009 Song et al. D14/138 AB
D604,262 S * 11/2009 Lee D14/138 AB
D606,508 S * 12/2009 Wun et al. D14/138 AB
D608,748 S * 1/2010 Jeon et al. D14/138 AB
D616,846 S * 6/2010 Byun et al. D14/138 AB
2007/0167197 A1 * 7/2007 Fuke et al. 455/575.1
2007/0178949 A1 * 8/2007 Sato et al. 455/575.3
2009/0233658 A1 * 9/2009 Murayama et al. 455/575.3
2009/0298559 A1 * 12/2009 Ma 455/575.3

2010/0075726 A1* 3/2010 Han et al. 455/575.3

OTHER PUBLICATIONS

Motorola A1200 telephone, announced Dec. 2005, [online], [site visited Jun. 18, 2010]. Available from Internet ,<URL: <http://www.gsmarena.com>>.*

Motorola PEBL VU20A1200 telephone, announced Jul. 2008, [online], [site visited Jun. 18, 2010]. Available from Internet ,<URL: <http://www.gsmarena.com>>.*

Motorola EM28 telephone, announced Aug. 2008, [online], [site visited Jun. 18, 2010]. Available from Internet ,<URL: <http://www.gsmarena.com>>.*

Motorola WX265 telephone, announced Apr. 2010, [online], [site visited Jun. 18, 2010]. Available from Internet ,<URL: <http://www.gsmarena.com>>.*

Samsung M310 telephone, announced May 2008, [online], [site visited Jun. 18, 2010]. Available from Internet ,<URL: <http://www.gsmarena.com>>.*

U.S. Appl. No. 29/317,468, filed Apr. 30, 2009 in the name of Mark D. Finney, entitled "Communication Device".

U.S. Appl. No. 29/317,469, filed Apr. 30, 2009, in the name of Mark D. Finney, entitled "Communication Device".

* cited by examiner

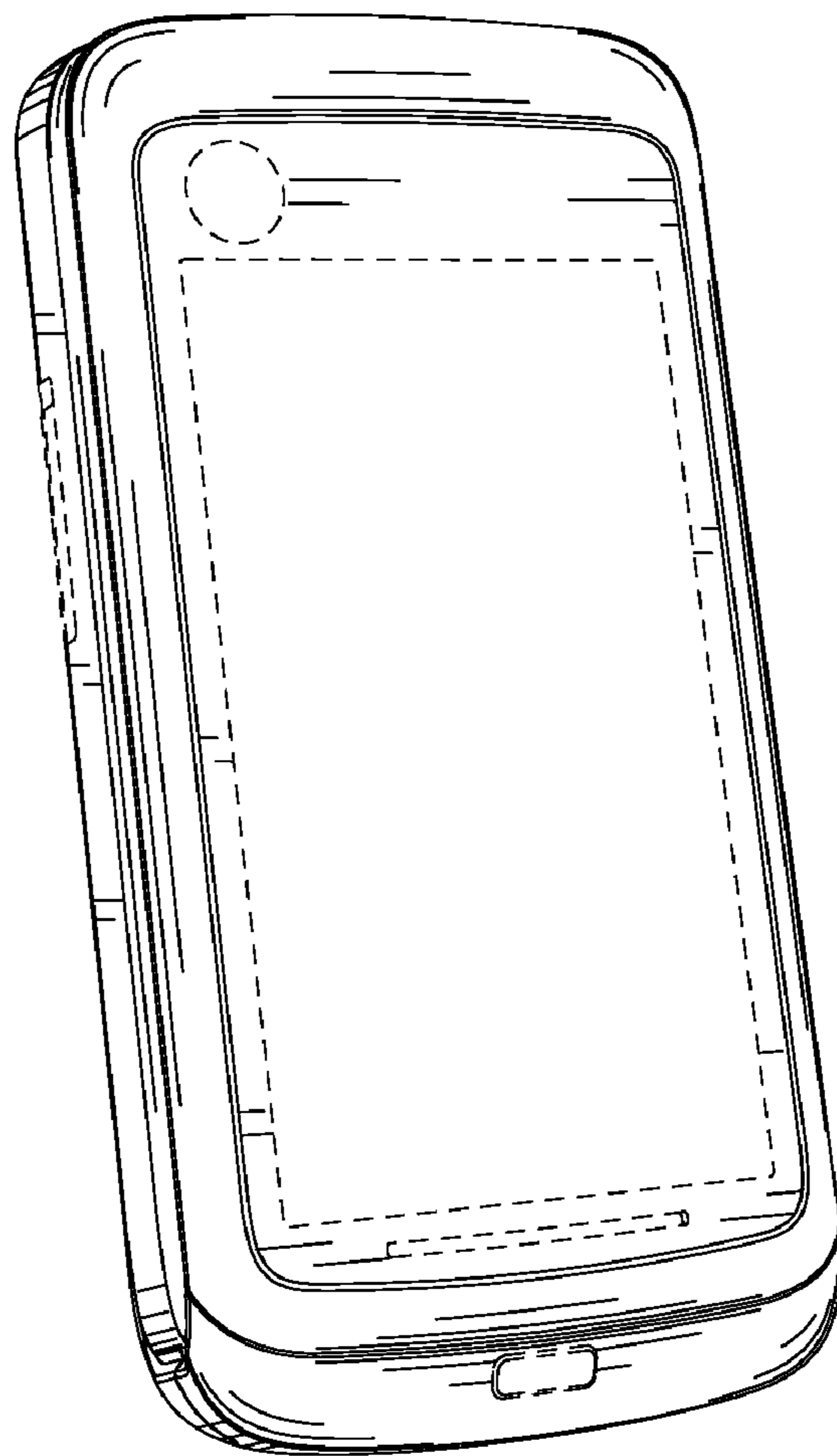

FIG. 1

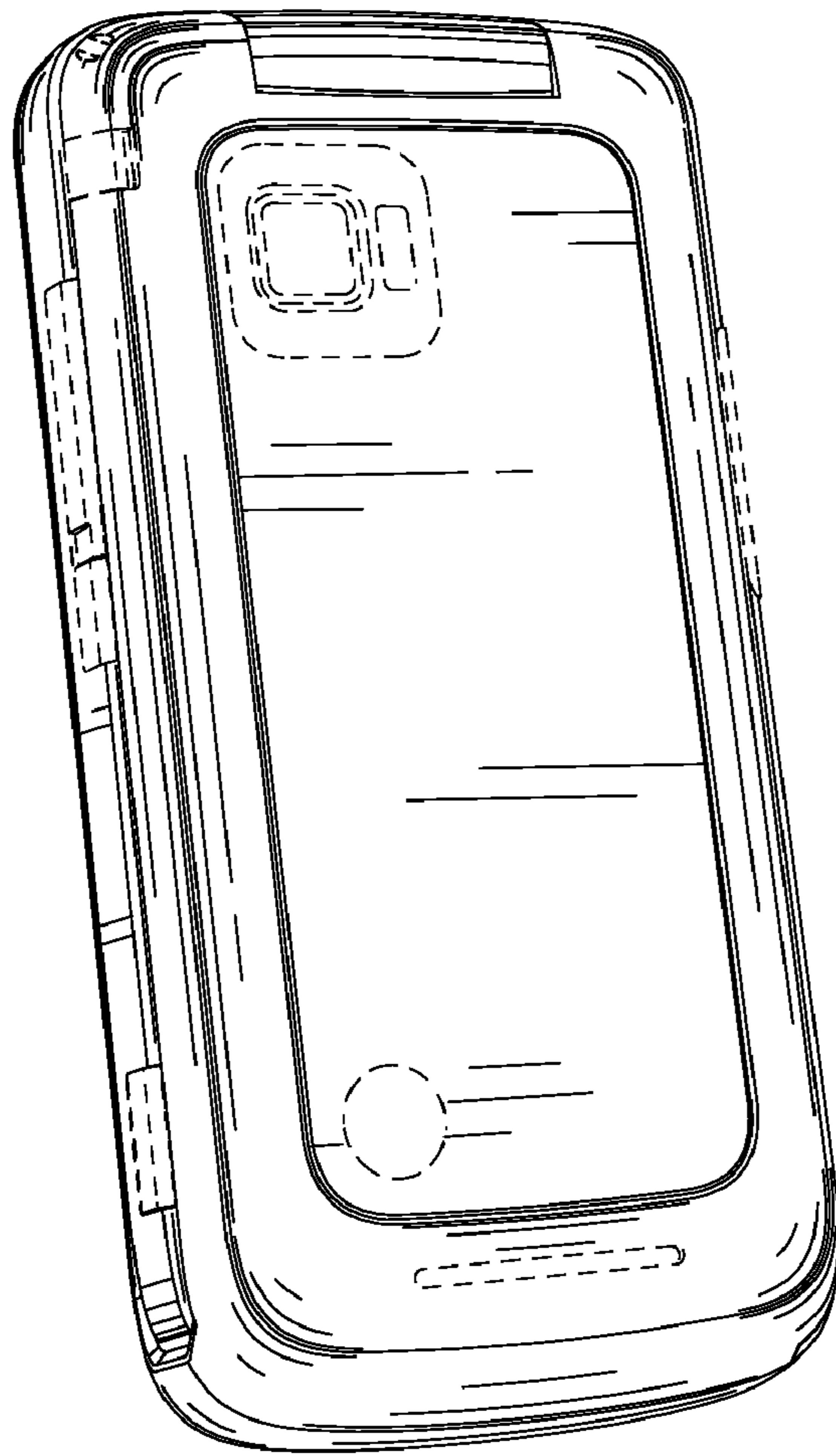

FIG. 2

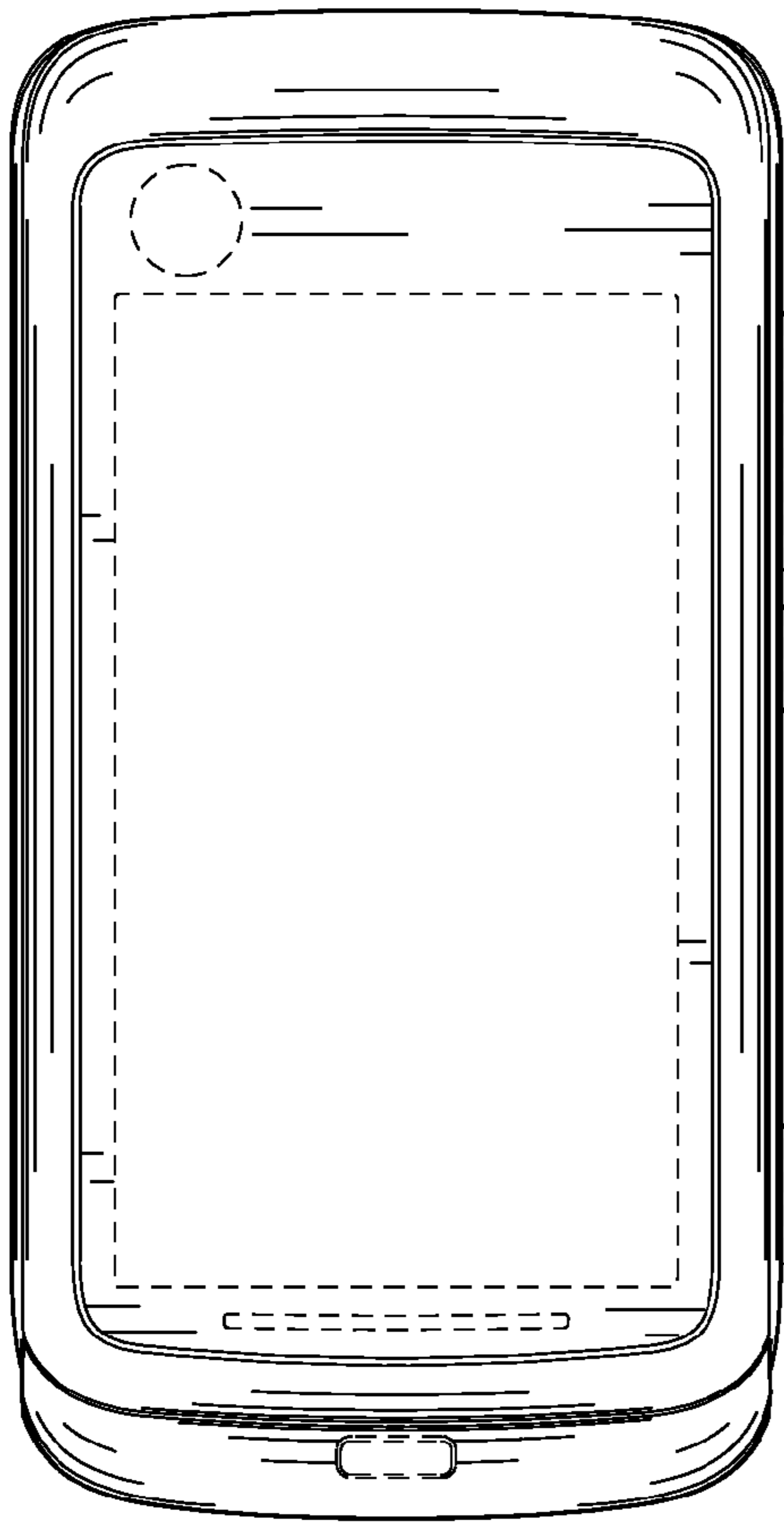

FIG. 3

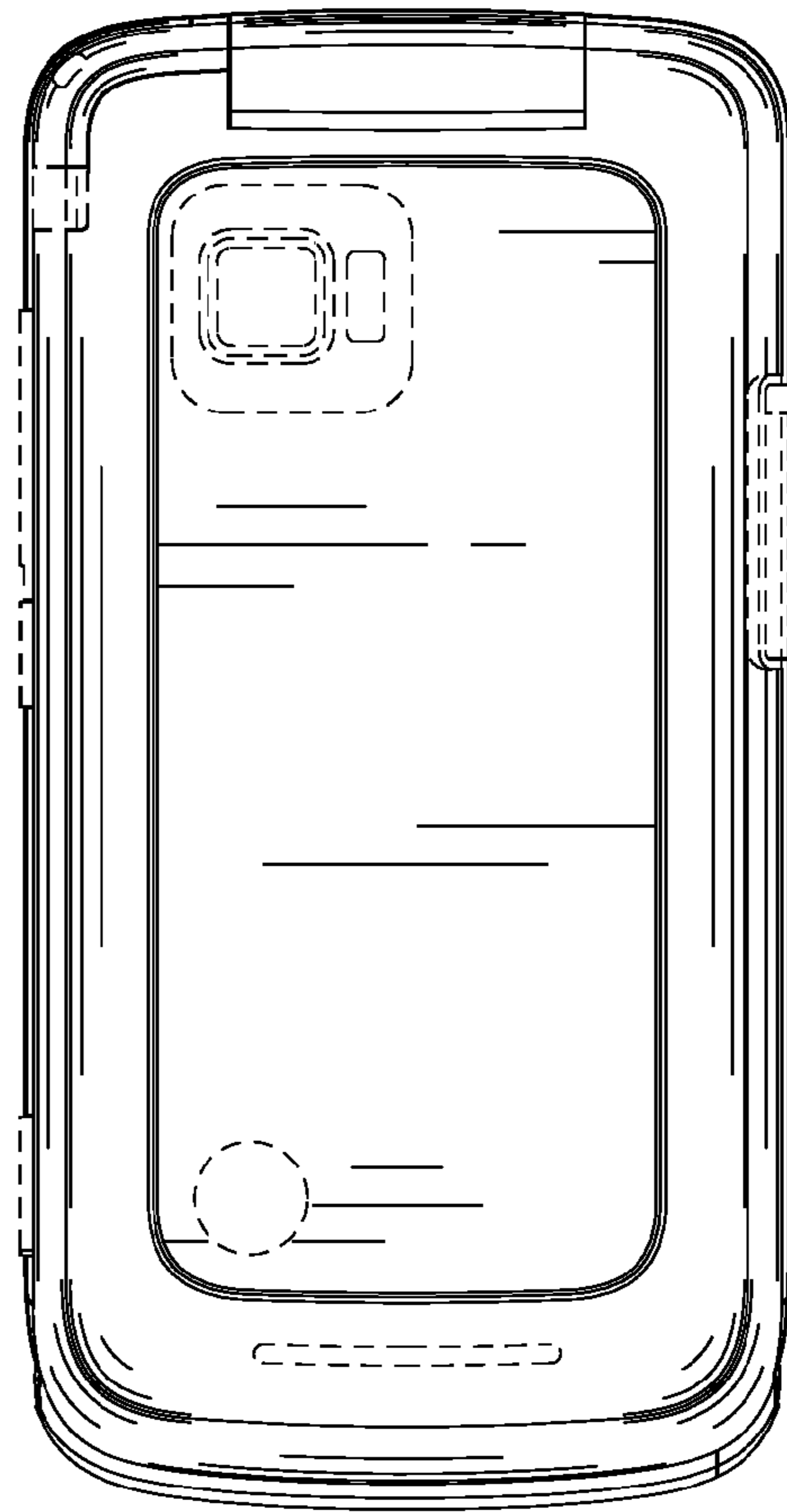

FIG. 4

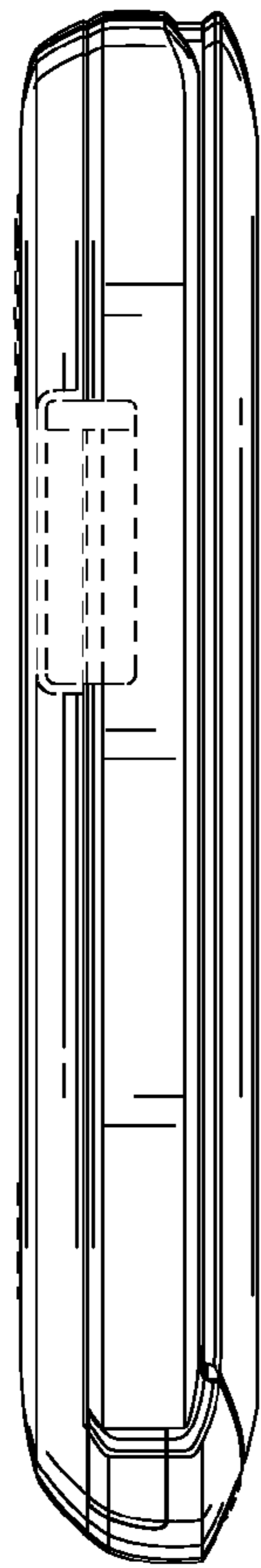

FIG. 5

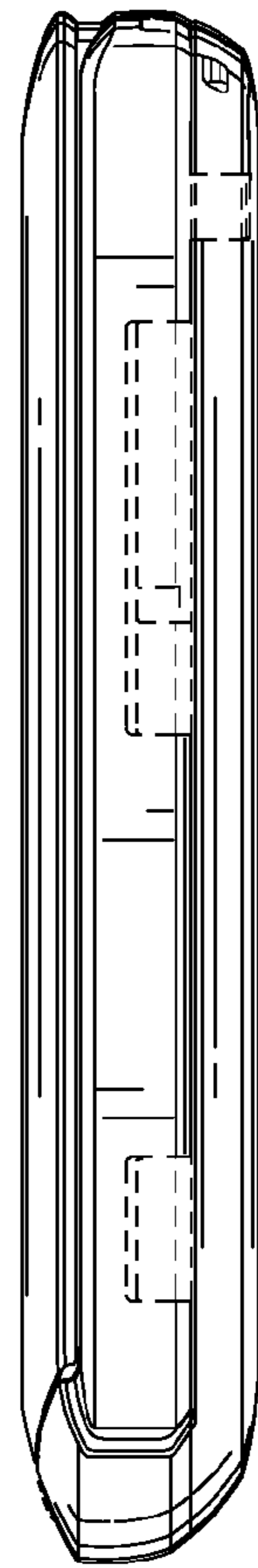

FIG. 6

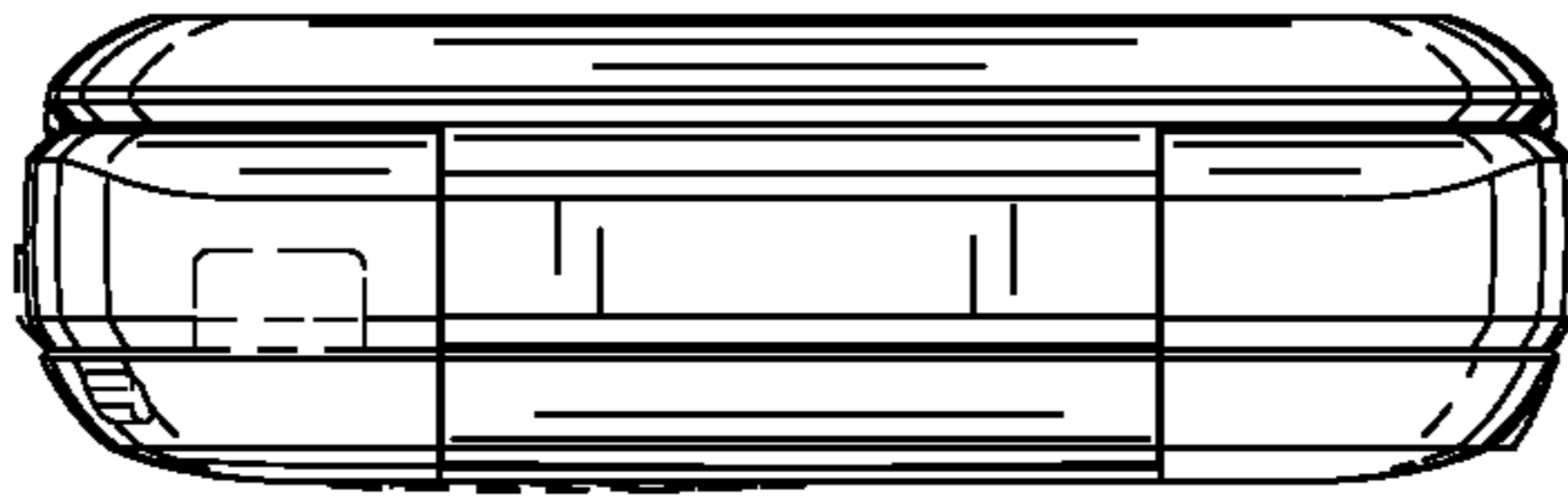

FIG. 7

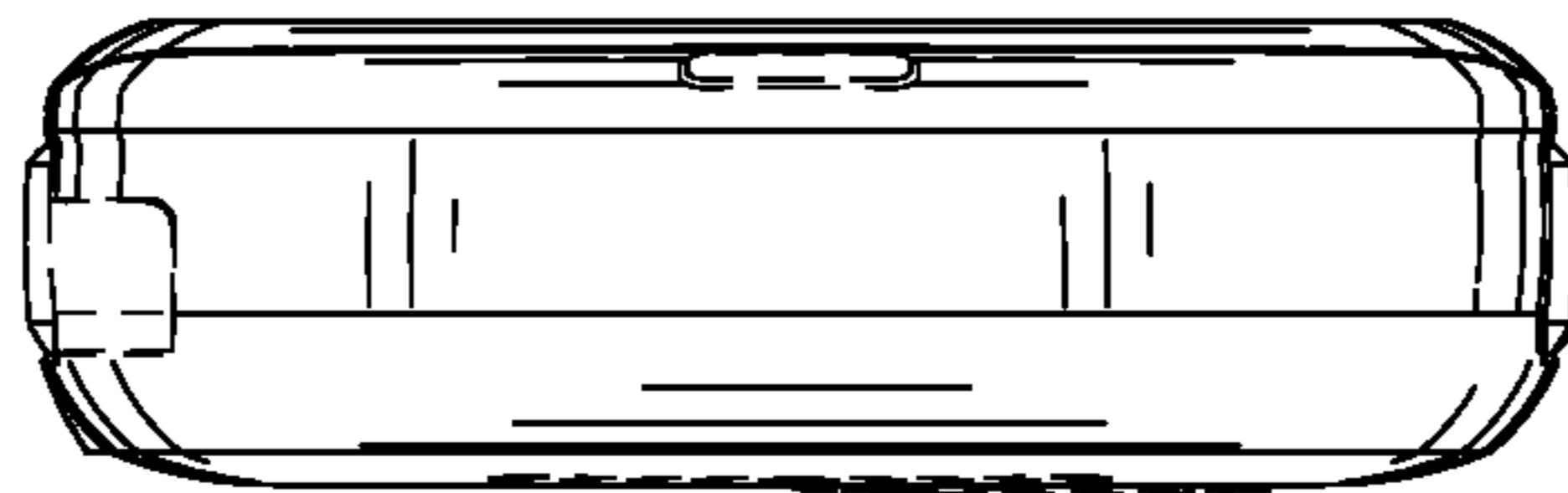

FIG. 8

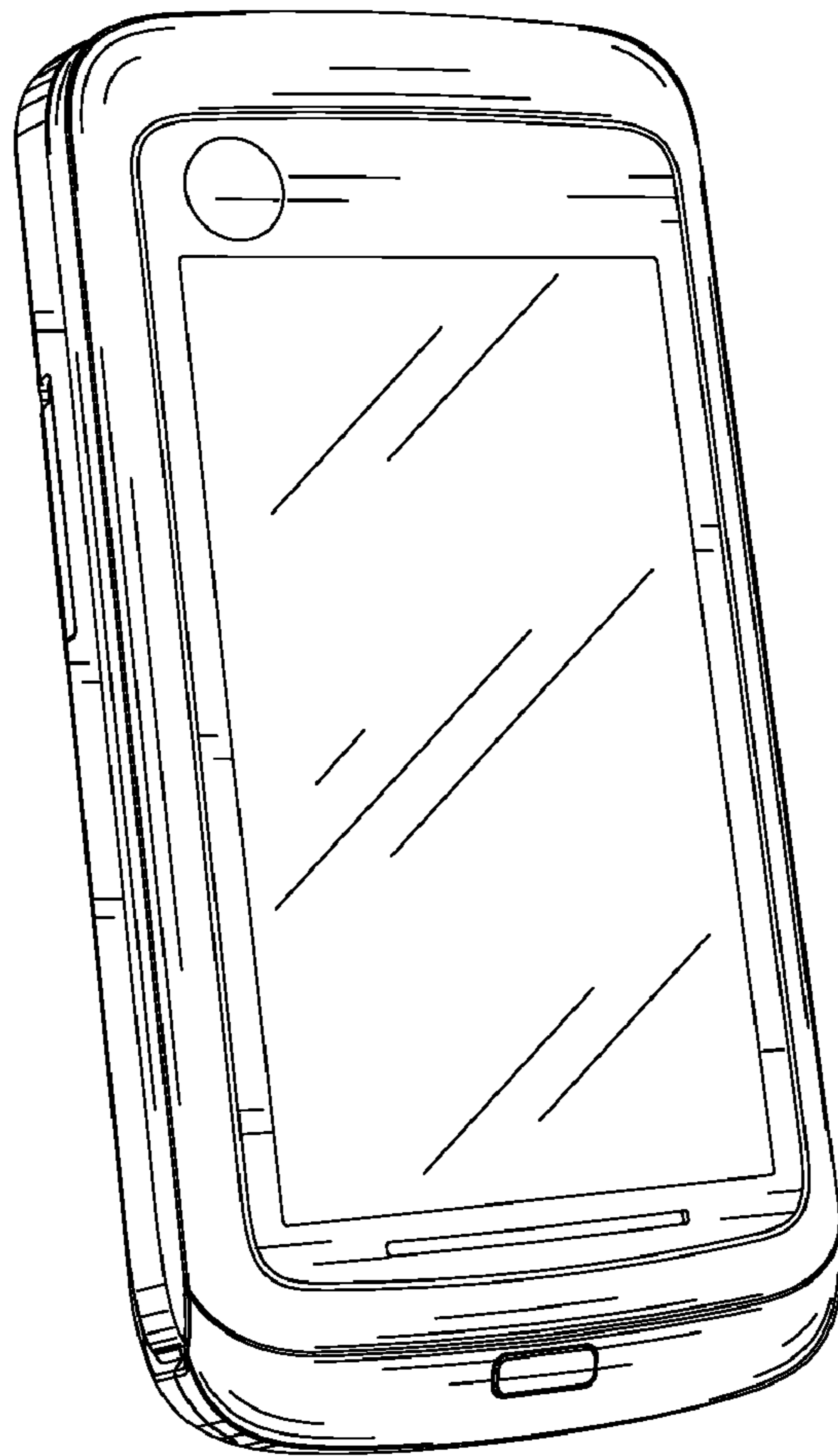

FIG. 9

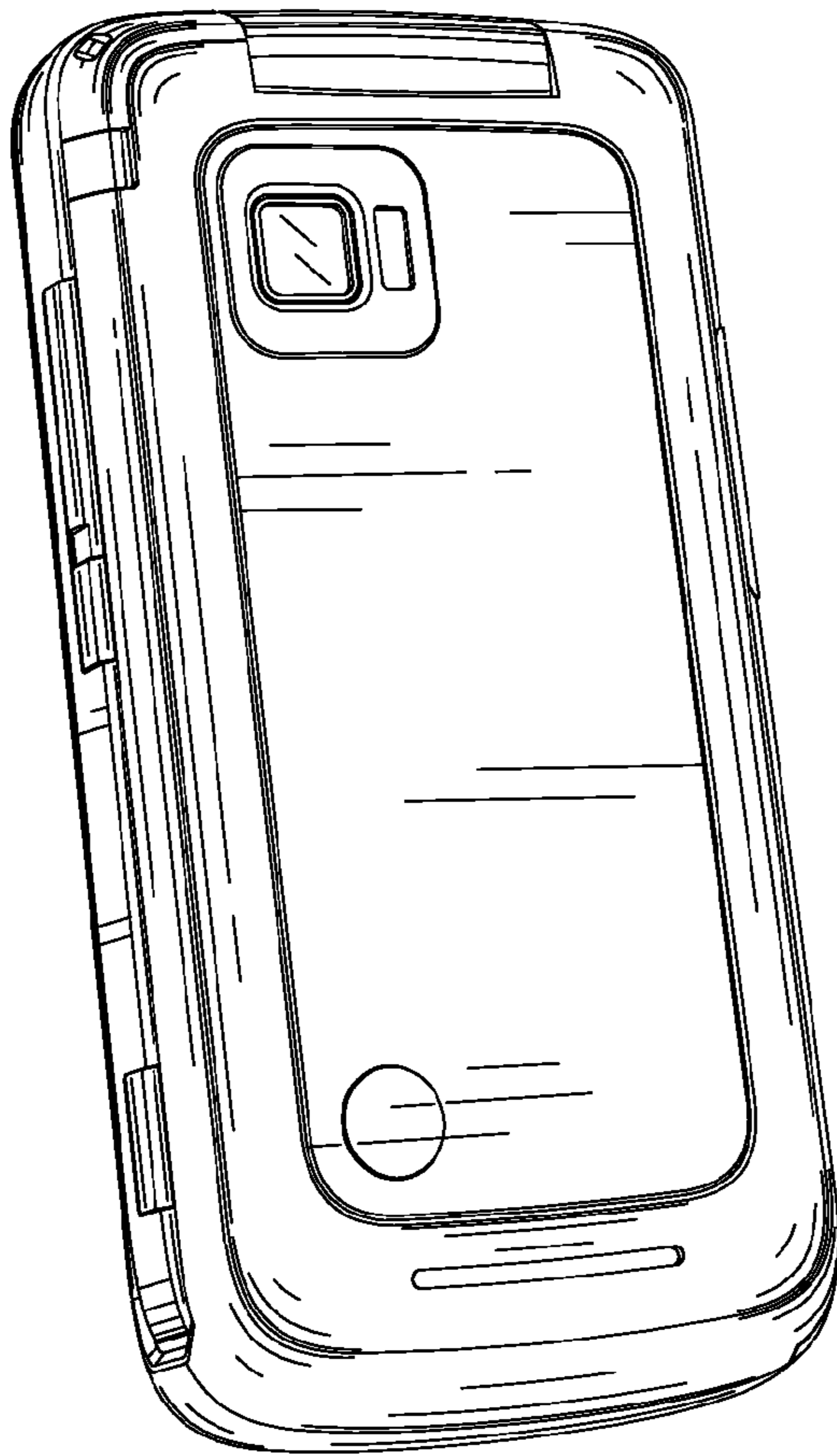

FIG. 10

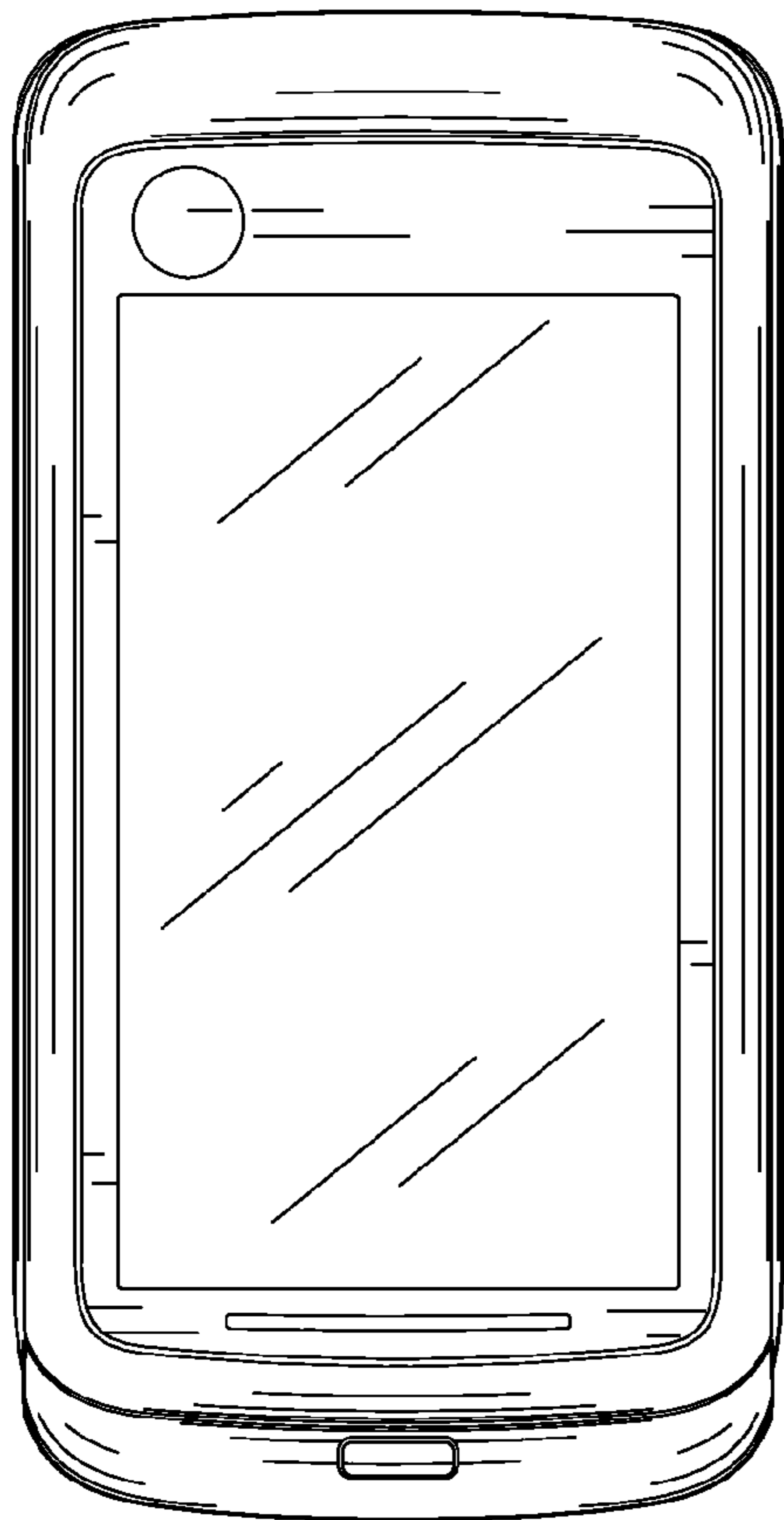

FIG. 11

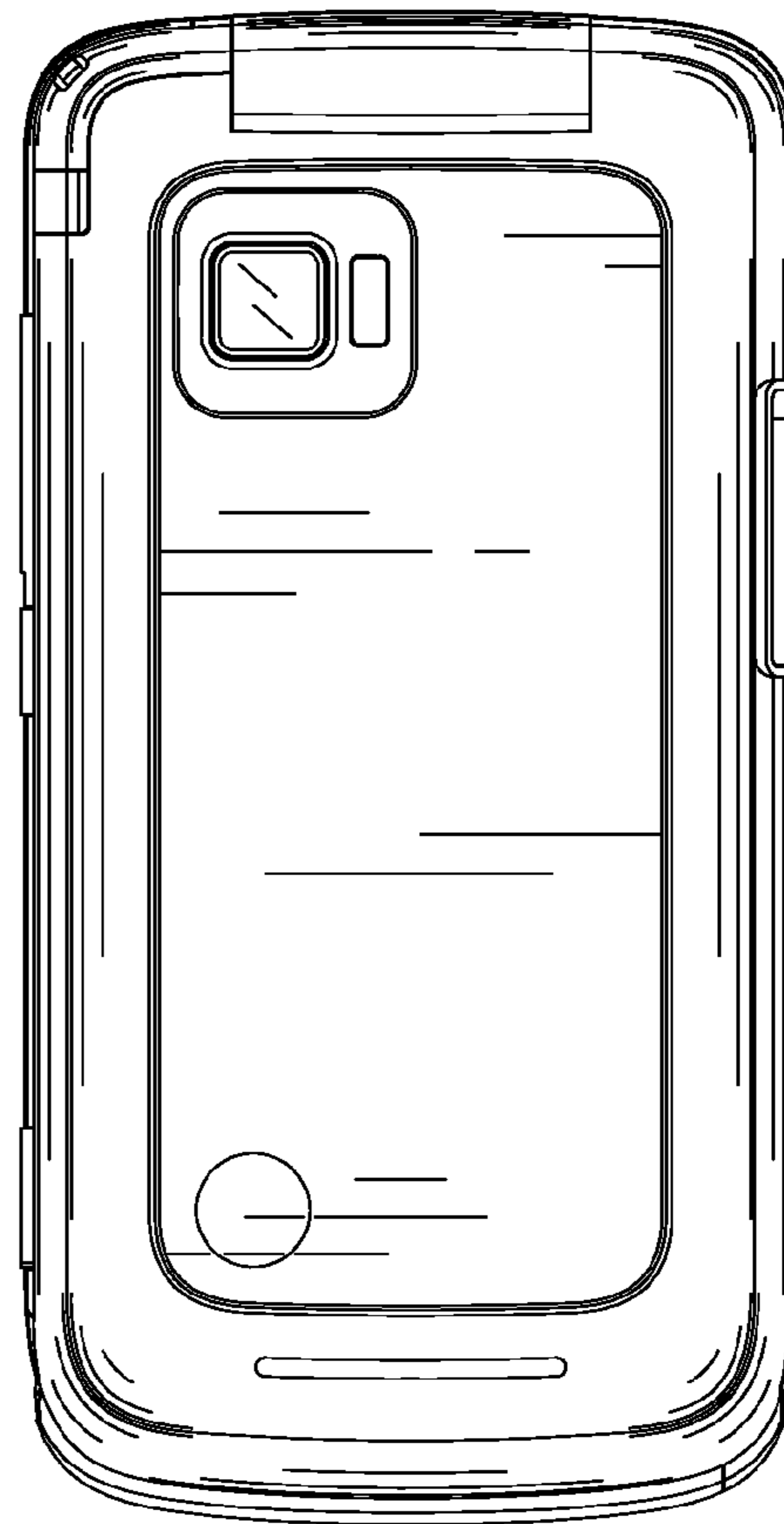

FIG. 12

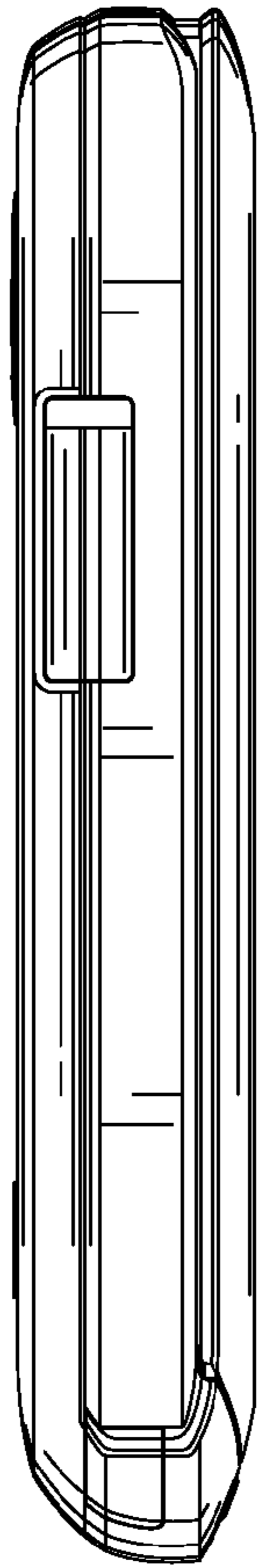

FIG. 13

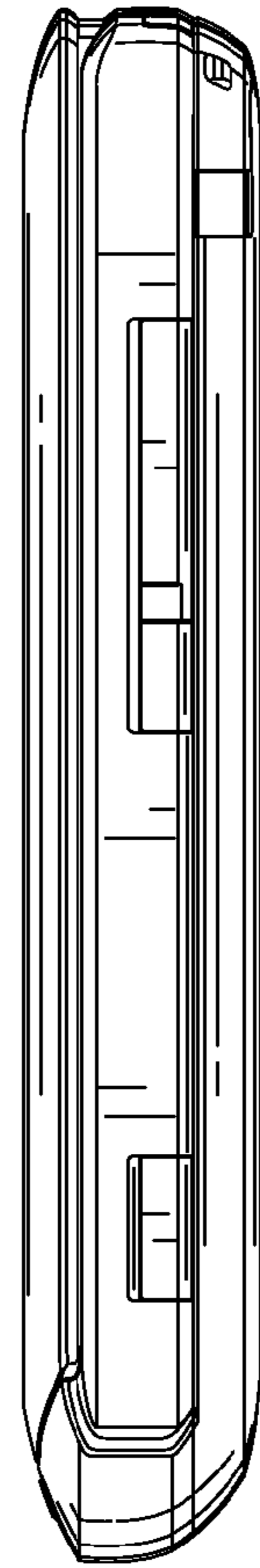

FIG. 14

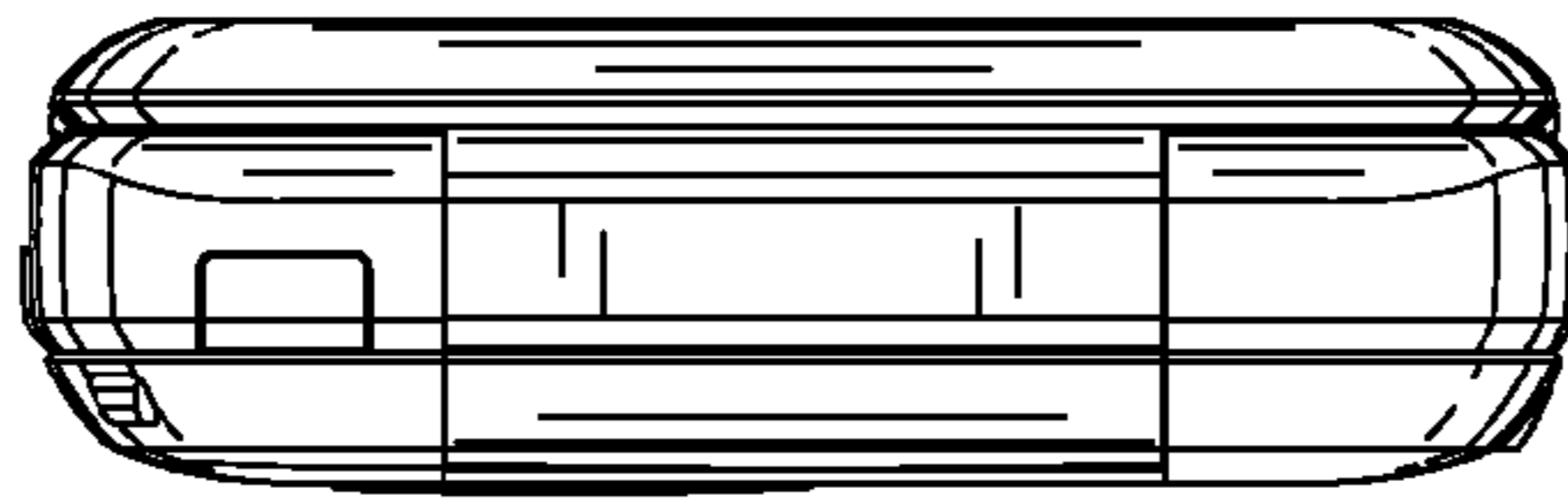

FIG. 15

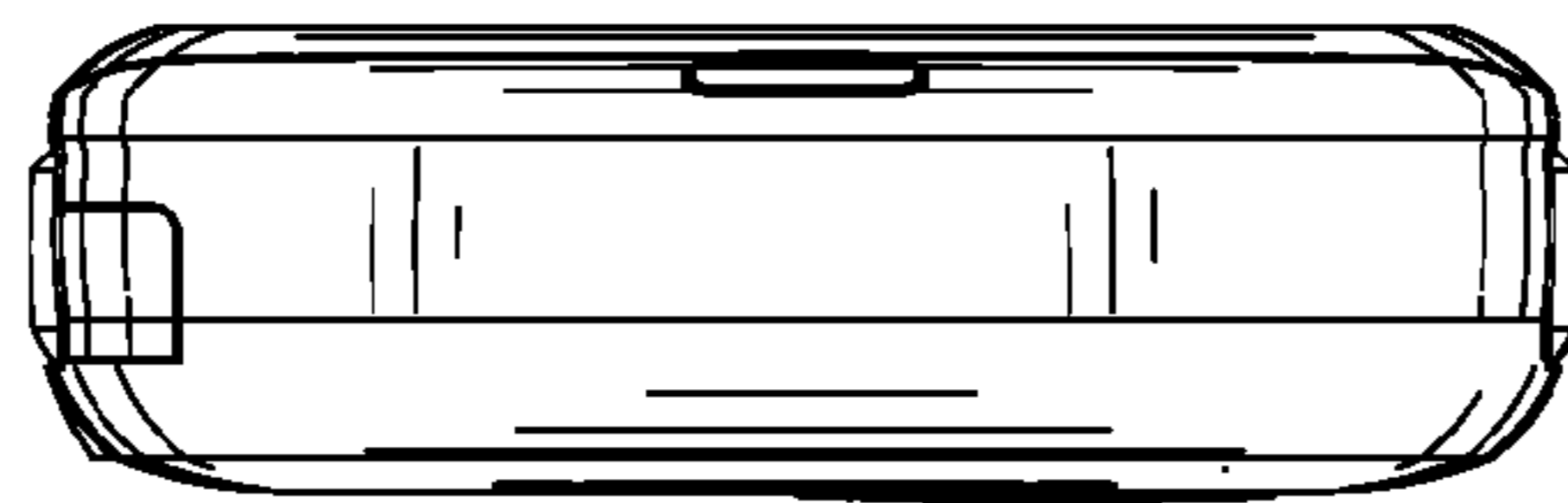

FIG. 16