

US00D627256S

(12) **United States Design Patent**
Thomas

(10) **Patent No.:** **US D627,256 S**
(45) **Date of Patent:** **** Nov. 16, 2010**

(54) **SCRIPTURE TREE WITH VASE SUPPORT**

(76) Inventor: **Teresa A. Thomas**, 917 E. Madison, El Dorado, AR (US) 71731

(**) Term: **14 Years**

(21) Appl. No.: **29/348,450**

(22) Filed: **Jan. 8, 2010**

(51) **LOC (9) Cl.** **11-04**

(52) **U.S. Cl.** **D11/118; D11/117**

(58) **Field of Classification Search** D11/117,
D11/118, 121, 122, 123, 124, 125, 127, 130,
D11/131, 132, 133, 134, 144, 157, 158; 428/7-9,
428/12, 17, 18, 19, 20

See application file for complete search history.

(56) **References Cited**

U.S. PATENT DOCUMENTS

D143,745 S *	2/1946	Miller	D6/302
D229,081 S *	11/1973	Martinelli	D7/509
D259,163 S *	5/1981	Leard et al.	D6/302
D270,882 S *	10/1983	Wilson	D6/301
D273,312 S *	4/1984	Guertin	D21/337
D285,751 S *	9/1986	Timarac	D6/301
D295,054 S *	4/1988	Allen	D19/59
D317,732 S *	6/1991	Vernon	D11/117
D355,043 S *	1/1995	Sibley	D26/69
D361,292 S *	8/1995	Weder et al.	D11/164
D386,116 S *	11/1997	Sanderson	D11/153

D401,622 S *	11/1998	Ford	D19/26
D442,804 S *	5/2001	Parks	D6/450
D453,910 S *	2/2002	Jones, II	D11/157
D475,320 S *	6/2003	Hensley et al.	D11/157
D475,530 S *	6/2003	Dunn	D11/143
D476,262 S *	6/2003	Hensley et al.	D11/157
D505,638 S *	5/2005	Tabor	D11/125
D524,691 S *	7/2006	Caruso	D11/152
D587,625 S *	3/2009	White	D11/152

* cited by examiner

Primary Examiner—Stella M Reid

Assistant Examiner—Elizabeth J Oswecki

(74) *Attorney, Agent, or Firm*—John M. Harrison

(57) **CLAIM**

The ornamental design for a scripture tree with vase support, as shown and described.

DESCRIPTION

FIG. 1 is a front perspective view of a scripture tree with vase support showing my new design;

FIG. 2 is a front elevational view thereof;

FIG. 3 is a rear elevational view thereof;

FIG. 4 is a left side elevational view thereof;

FIG. 5 is a right side elevational view thereof;

FIG. 6 is a top plan view thereof; and,

FIG. 7 is a bottom plan view thereof.

1 Claim, 5 Drawing Sheets

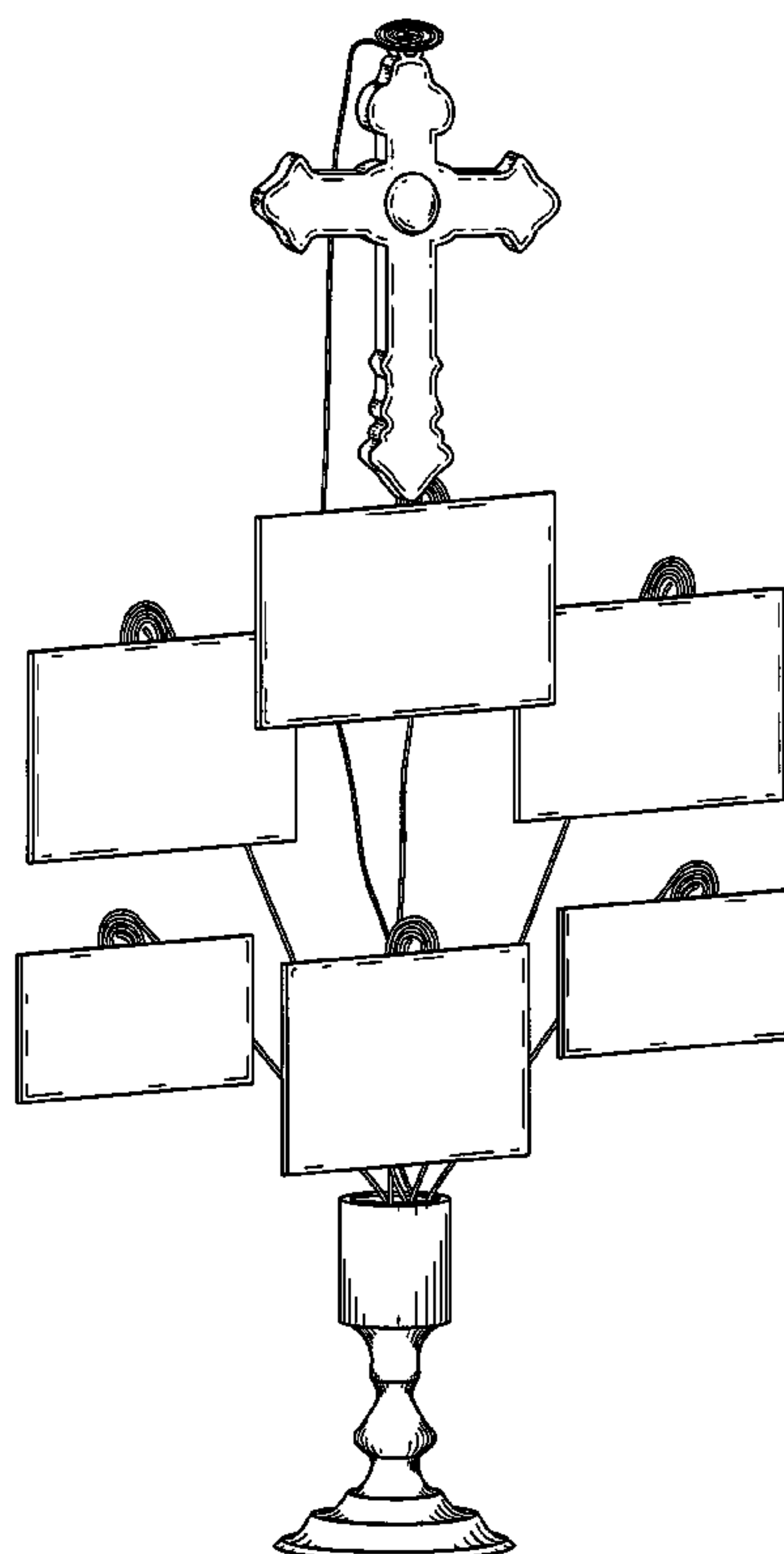

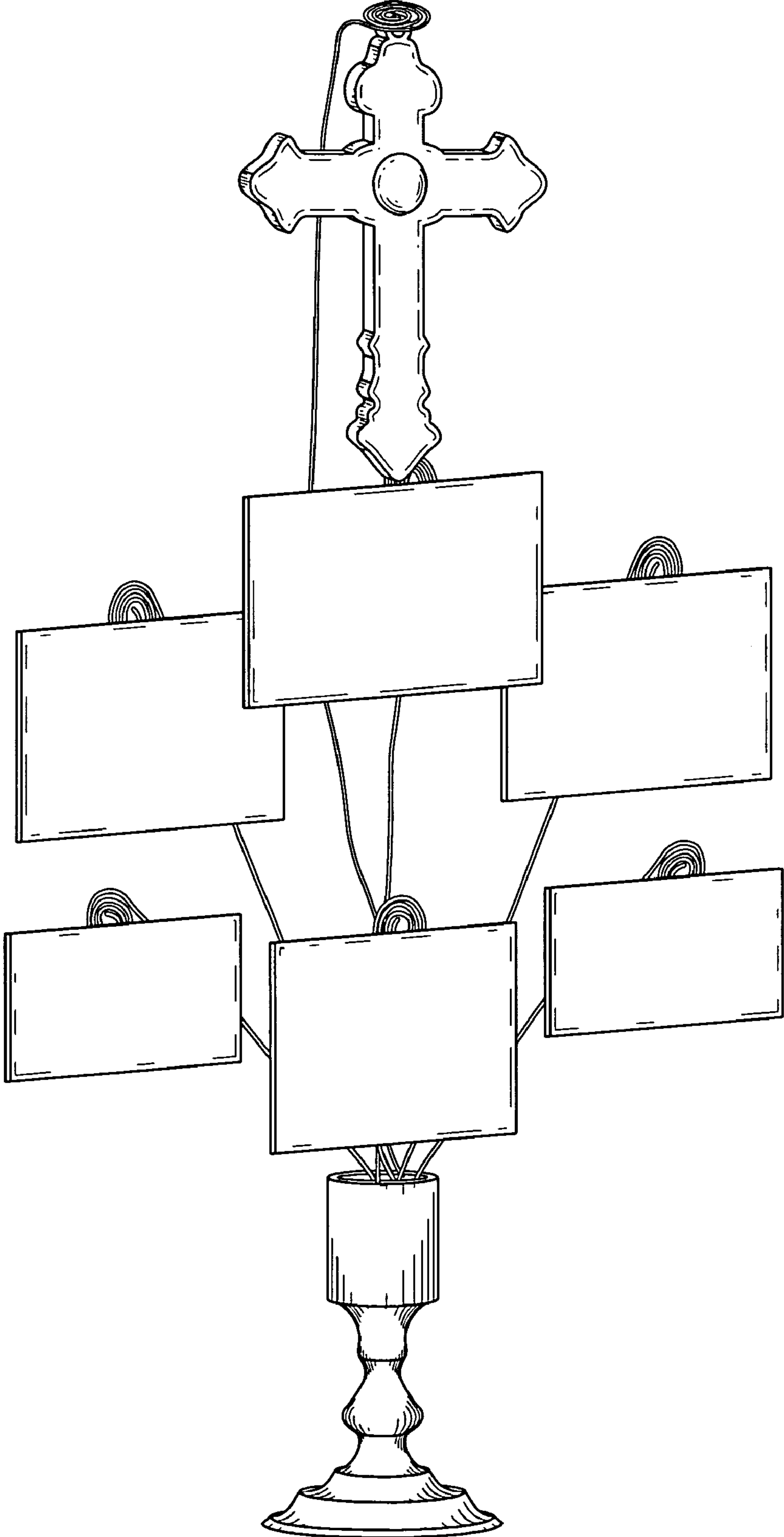

FIG. 1

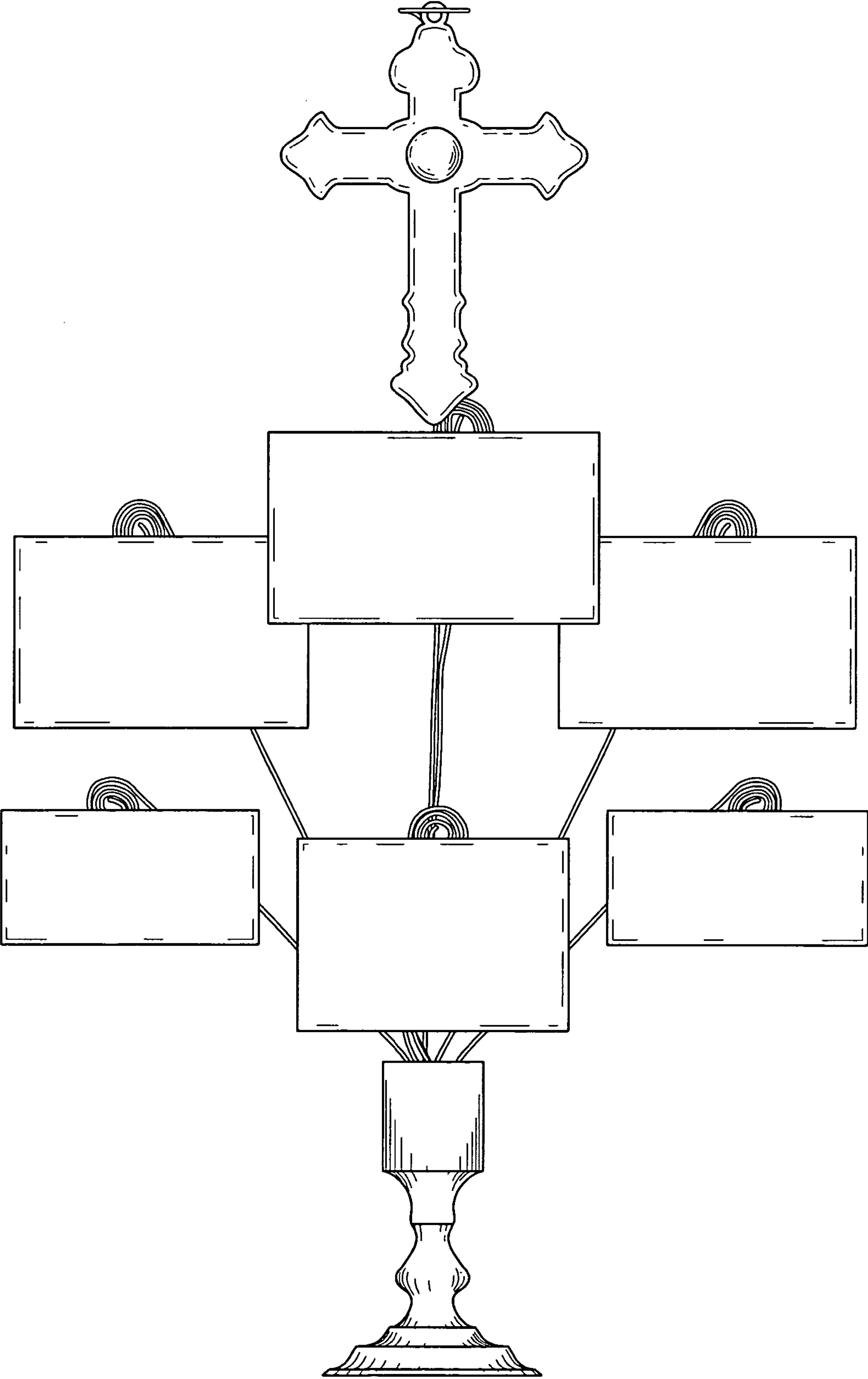

FIG. 2

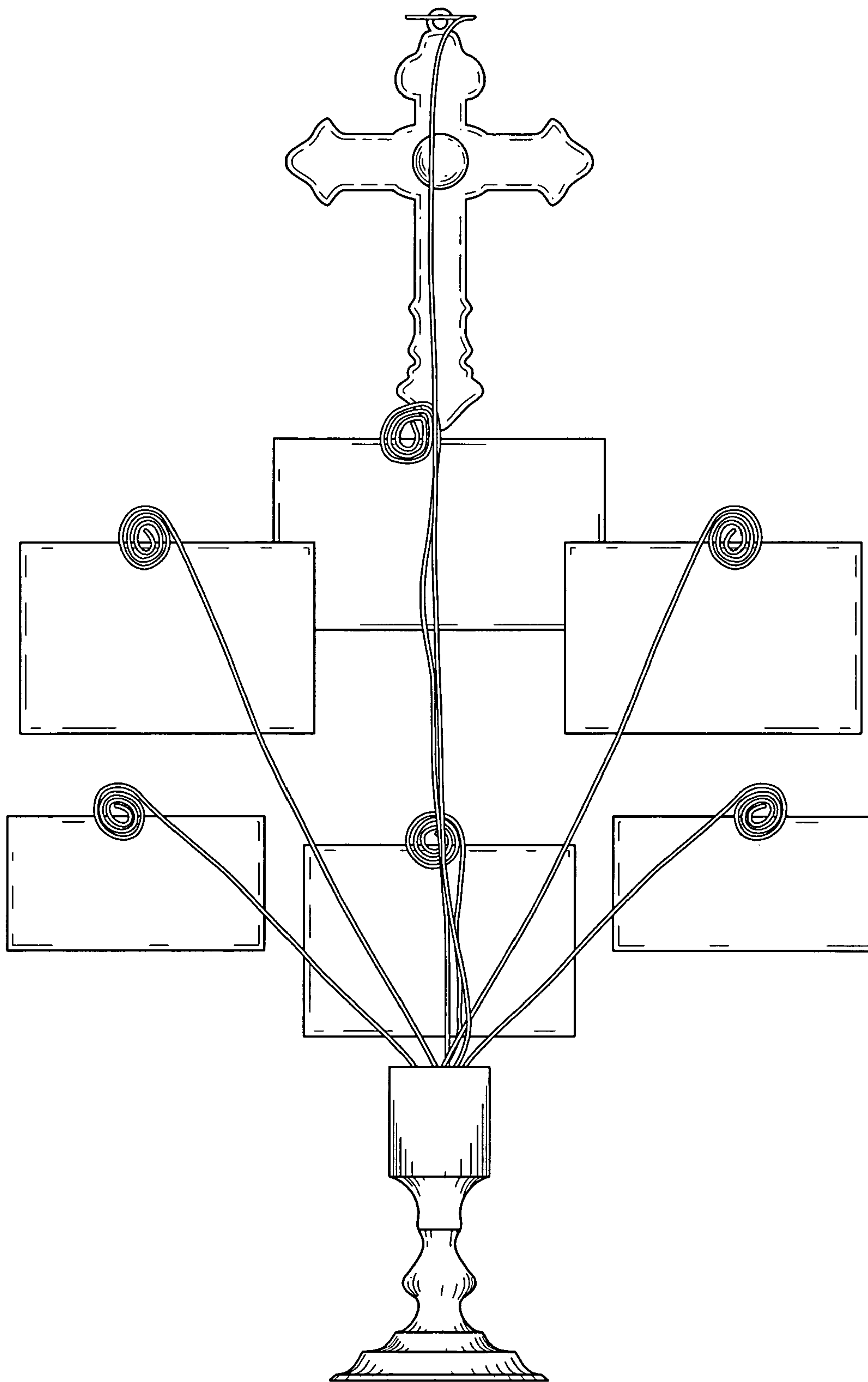

FIG. 3

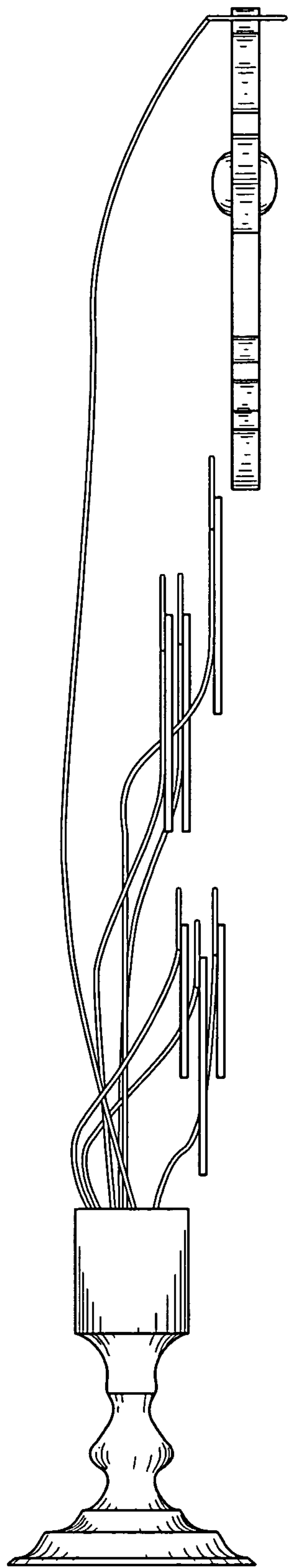

FIG. 4

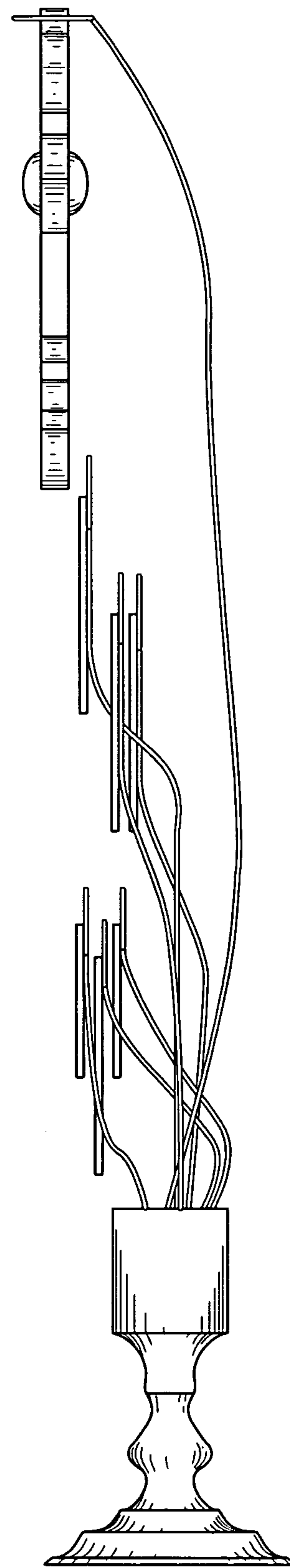

FIG. 5

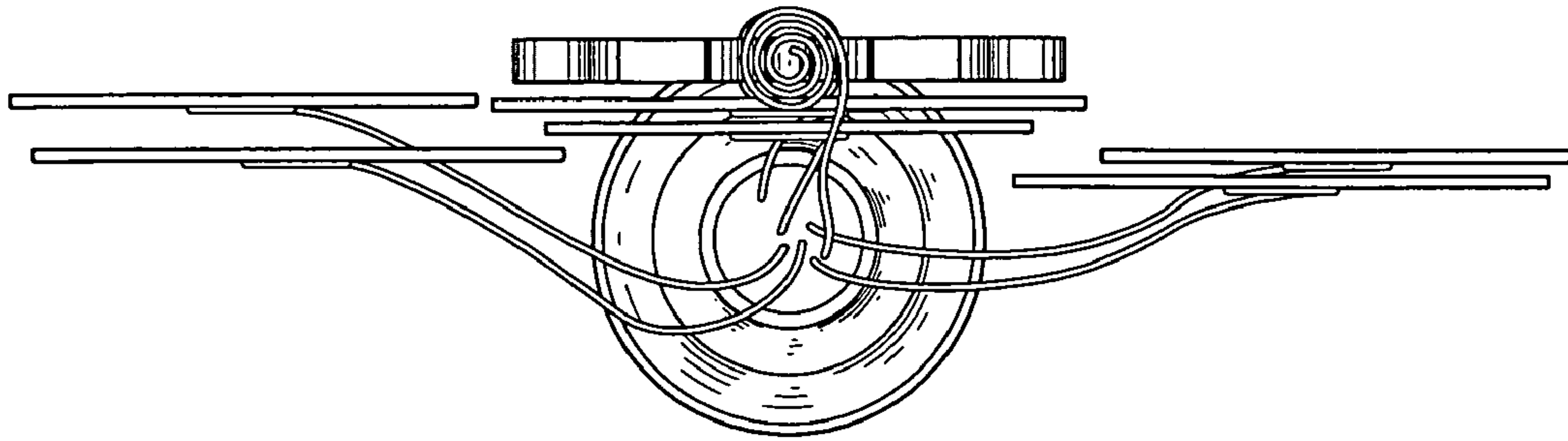

FIG. 6

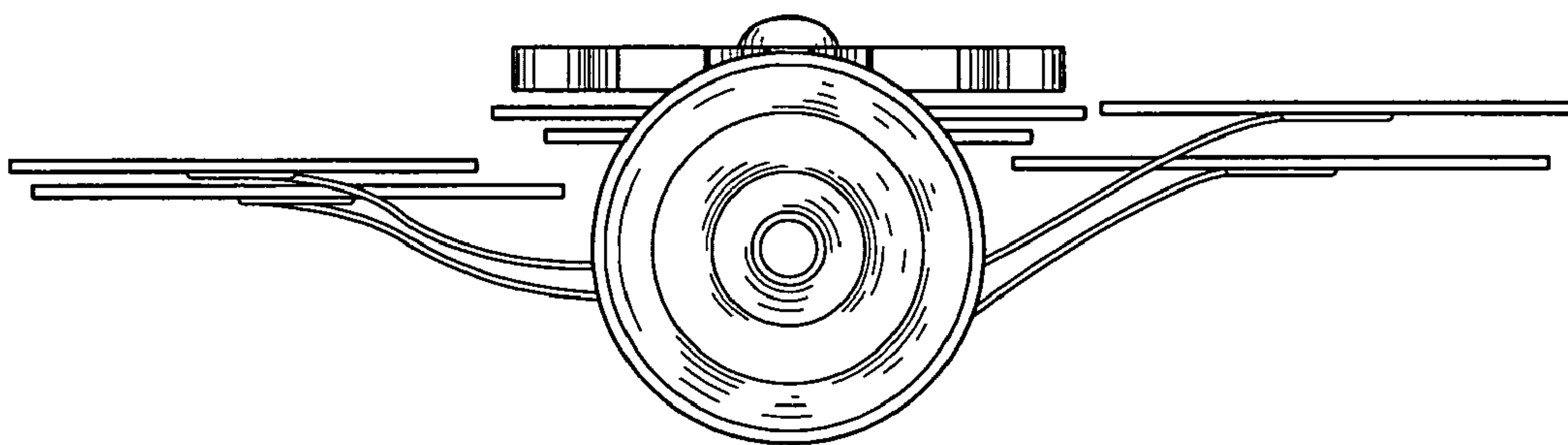

FIG. 7