



US00D627224S

(12) **United States Design Patent**
Bass et al.

(10) **Patent No.:** **US D627,224 S**
(45) **Date of Patent:** **** Nov. 16, 2010**

(54) **OVERCAP**
(75) Inventors: **Benjamin A. Bass**, Oak Creek, WI (US);
Allen D. Miller, Racine, WI (US)
(73) Assignee: **S.C. Johnson & Son, Inc.**, Racine, WA
(US)

4,325,497 A 4/1982 Ewald
4,328,911 A 5/1982 Knickerbocker
4,428,509 A 1/1984 Emerson et al.
4,442,955 A 4/1984 Bush
4,506,808 A 3/1985 Goncalves

(**) Term: **14 Years**
(21) Appl. No.: **29/345,067**
(22) Filed: **Oct. 8, 2009**

(Continued)

FOREIGN PATENT DOCUMENTS

WO WO02064449 8/2002

(51) **LOC (9) Cl.** **09-07**
(52) **U.S. Cl.** **D9/445; D9/443; D9/448**
(58) **Field of Classification Search** D9/456,
D9/455, 448, 447, 445, 438, 434, 763, 772;
D7/605, 387, 213; D3/211, 207; D23/226;
40/307; 239/333, 331; 222/635, 631, 566,
222/321.9, 321.8, 321.7, 320, 251; 220/915,
220/269, 268, 258.5

(Continued)

Primary Examiner—Susan Bennett Hattan

(57) **CLAIM**

The ornamental design for an overcap, as shown and described.

See application file for complete search history.

DESCRIPTION

(56) **References Cited**
U.S. PATENT DOCUMENTS

2,887,273 A 3/1955 Anderson et al.
3,143,254 A 8/1964 Vanderhyde
3,158,292 A 11/1964 O'Donnell
3,169,673 A 2/1965 Focht
3,185,349 A 5/1965 Sagarin
3,312,723 A 4/1967 Anderson et al.
3,317,092 A 5/1967 Jurasek
3,373,908 A 3/1968 Crowell
D218,145 S 7/1970 Doblin
3,580,432 A 5/1971 Brooks
3,611,820 A 10/1971 Hempel
3,648,905 A 3/1972 Kauder
3,698,604 A 10/1972 Nigro
3,729,119 A 4/1973 Sette et al.
3,848,778 A 11/1974 Meshberg
3,860,149 A 1/1975 Hagianis
4,053,090 A 10/1977 Kelly et al.
4,264,037 A 4/1981 Nozawa
4,277,004 A 7/1981 Barlics

FIG. 1 is a top isometric view of an overcap according to the present invention;
FIG. 2 is a side elevational view of a first side of the overcap of FIG. 1;
FIG. 3 is a side elevational view of a second side of the overcap of FIG. 1, the second side being opposite the first side;
FIG. 4 is a side elevational view of a third side of the overcap of FIG. 1;
FIG. 5 is a side elevational view of a fourth side of the overcap of FIG. 1, the fourth side being opposite the third side;
FIG. 6 is a top plan view of the overcap of FIG. 1; and,
FIG. 7 is a bottom elevational view of the overcap of FIG. 1.
FIG. 7 is provided for context only and form no part of the claimed design. Further, structure shown in phantom forms no part of the claimed design.

1 Claim, 4 Drawing Sheets

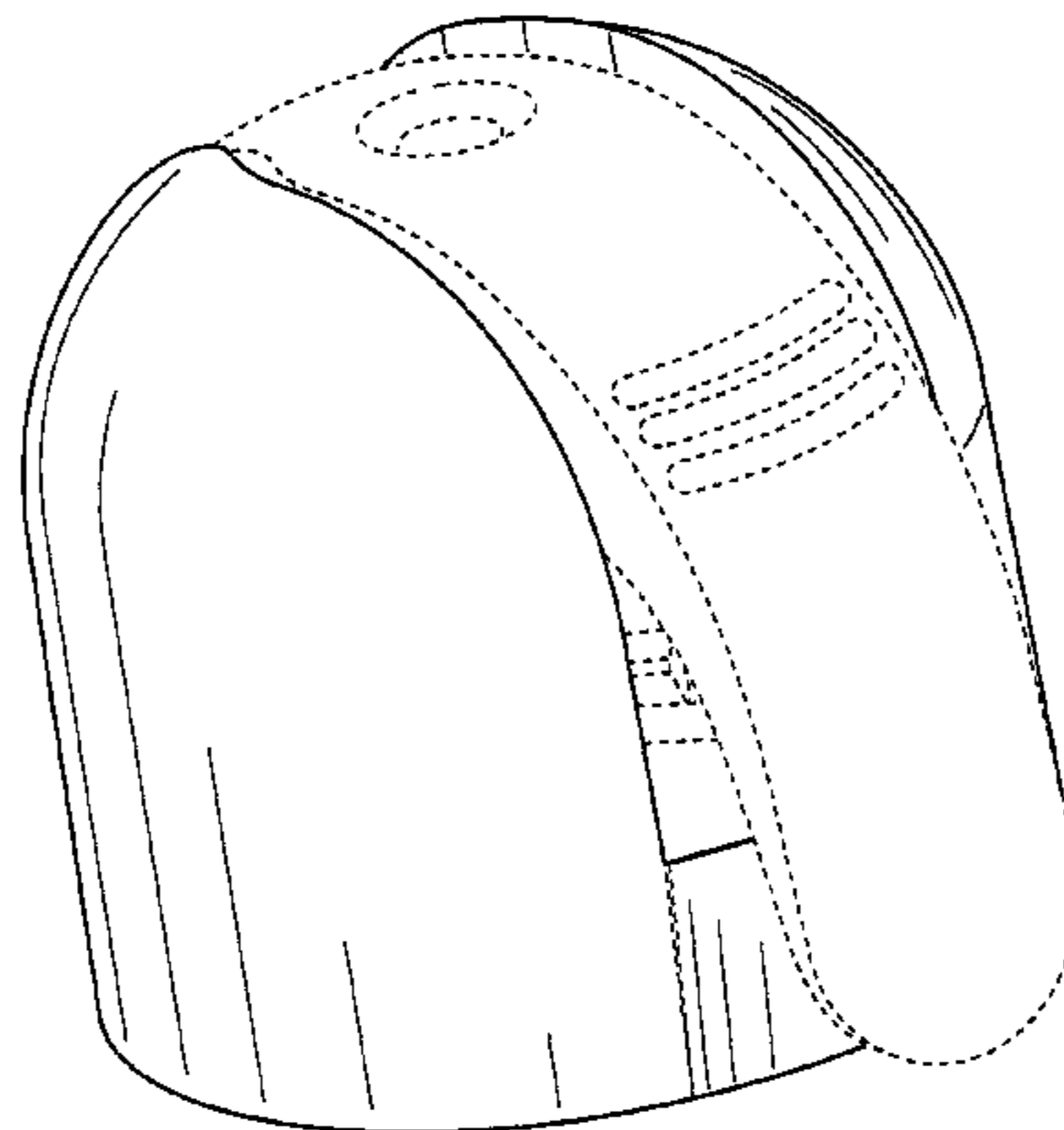

US D627,224 S

U.S. PATENT DOCUMENTS

4,679,713	A	7/1987	Crapser et al.
4,805,839	A	2/1989	Malek
4,898,307	A	2/1990	Tiramani
5,018,647	A	5/1991	Abplanalp
5,114,052	A	5/1992	Tiramani et al.
5,154,323	A	10/1992	Query et al.
D338,615	S	8/1993	Magidson et al.
5,249,713	A	10/1993	Reich
5,263,616	A	11/1993	Abplanalf
D349,642	S	8/1994	Abfier
5,388,730	A	2/1995	Abbott et al.
5,445,299	A	8/1995	Harriman
5,482,186	A	1/1996	Rodden, Jr.
5,503,303	A	4/1996	LaWare et al.
5,507,437	A	4/1996	Foster et al.
5,509,608	A	4/1996	Foster et al.
5,513,800	A	5/1996	Foster et al.
5,586,693	A	12/1996	DeLaforcade et al.
5,597,095	A	1/1997	Ferrara, Jr.
5,624,055	A	4/1997	Clanet
5,649,645	A	7/1997	Demarest et al.
5,702,036	A	12/1997	Ferrara, Jr.
5,791,524	A	8/1998	Demarest
5,823,396	A	10/1998	Vollmerhaus
5,890,632	A	4/1999	Chalupsky et al.
5,915,597	A	6/1999	DeLaforcade
5,975,376	A	11/1999	Chalupsky et al.
5,984,149	A	11/1999	Thanisch et al.
5,984,151	A	11/1999	Lohrman et al.
6,004,056	A	12/1999	De Laforcade
6,056,160	A	5/2000	Carlucci
6,216,912	B1	4/2001	Keung et al.
6,302,302	B1	10/2001	Albisetti
6,364,171	B1	4/2002	Chalupsky et al.
6,390,341	B1	5/2002	Ohmi et al.
D460,360	S	7/2002	Diete
6,454,139	B1	9/2002	Bayer
RE38,022	E	3/2003	De Laforcade
6,564,977	B2	5/2003	Uemura et al.
6,588,631	B2	7/2003	Sanchez
6,595,393	B1	7/2003	Loghman-Adham et al.
6,722,532	B2	4/2004	Lasserre
D489,980	S *	5/2004	Shurtleff et al. D9/448
6,763,979	B2	7/2004	Yamanaka et al.

6,899,253	B2	5/2005	Uemura et al.
6,908,017	B2	6/2005	Mineau et al.
6,939,072	B2	9/2005	Thiebaut
6,981,616	B2	1/2006	Loghman-Adham et al.
D515,920	S	2/2006	Groh et al.
7,004,359	B2	2/2006	Marroncles
7,017,785	B2	3/2006	Lasserre et al.
7,036,691	B2	5/2006	Nicolas
7,104,427	B2	9/2006	Pericard et al.
7,124,916	B2	10/2006	Groh
D536,970	S	2/2007	Shannan et al.
D538,650	S *	3/2007	Paas et al. D9/448
7,204,393	B2	4/2007	Strand
7,216,820	B2	5/2007	Nelson
7,249,692	B2	7/2007	Walters
D565,947	S	4/2008	Downey et al.
D569,723	S	5/2008	Sellick
D581,270	S	11/2008	Gonzalez et al.
7,487,891	B2	2/2009	Yerby et al.
7,497,214	B2	3/2009	Hodson
7,527,173	B2	5/2009	Lasserre
2004/0222246	A1	11/2004	Bates et al.
2005/0017026	A1	1/2005	Yerby et al.
2006/0151547	A1	7/2006	Kolanus
2007/0034649	A1	2/2007	Smith et al.
2007/0039979	A1	2/2007	Strand et al.
2007/0051754	A1	3/2007	Strand et al.
2007/0062980	A1	3/2007	Bates et al.
2007/0138214	A1	6/2007	De'Padova et al.
2007/0278253	A1	12/2007	Ruiz De Gopegui et al.
2007/0290007	A1	12/2007	Eberhardt
2008/0164285	A1	7/2008	Hygema

FOREIGN PATENT DOCUMENTS

WO	WO2004024221	3/2004
WO	WO2004099029	11/2004
WO	WO2006058627	6/2006
WO	WO2007021918	2/2007
WO	WO2007022422	2/2007
WO	WO2007140407	12/2007
WO	WO2007149459	12/2007
WO	WO2007149549	12/2007
WO	WO2008066012	6/2008

* cited by examiner

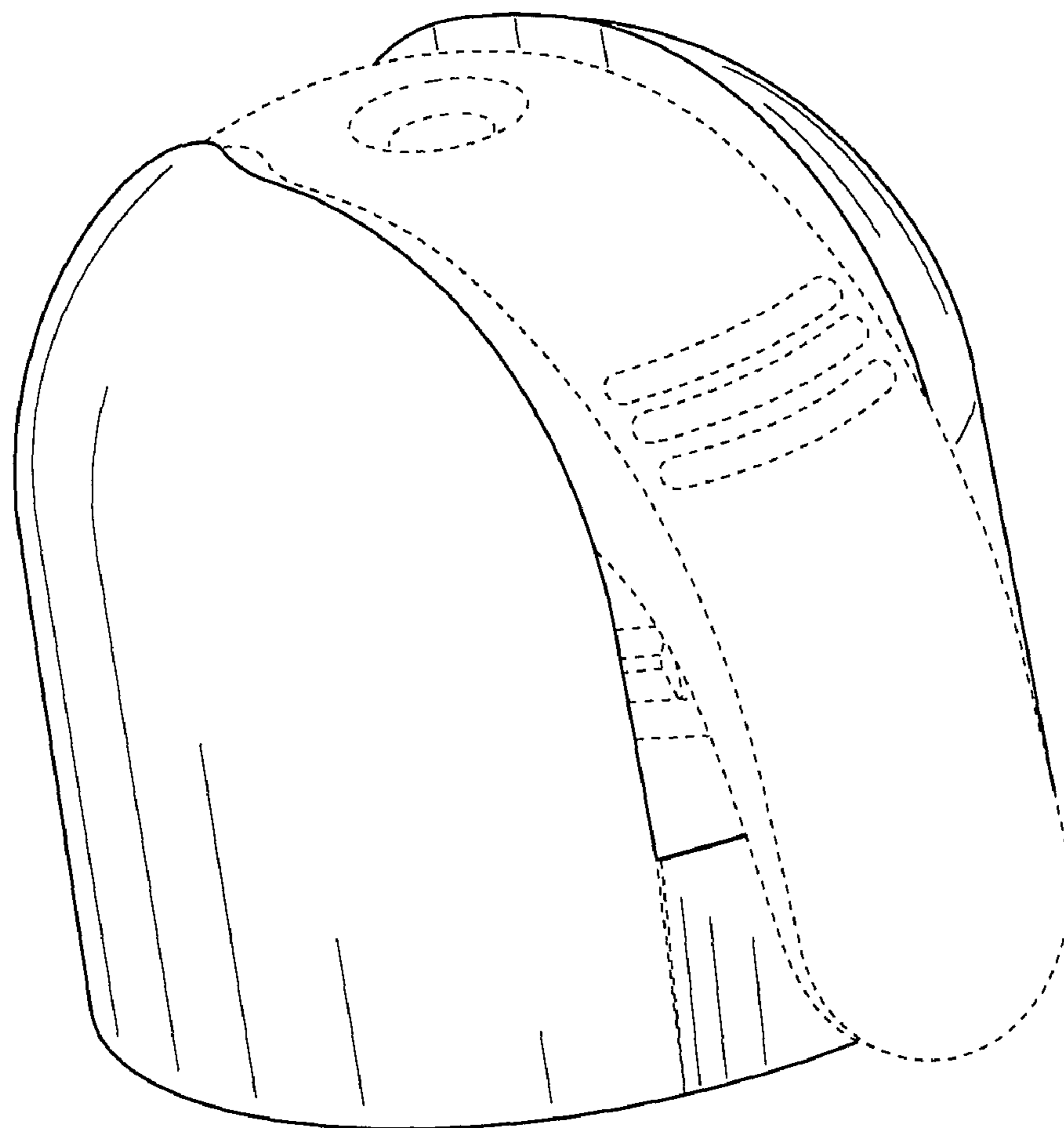

FIG. 1

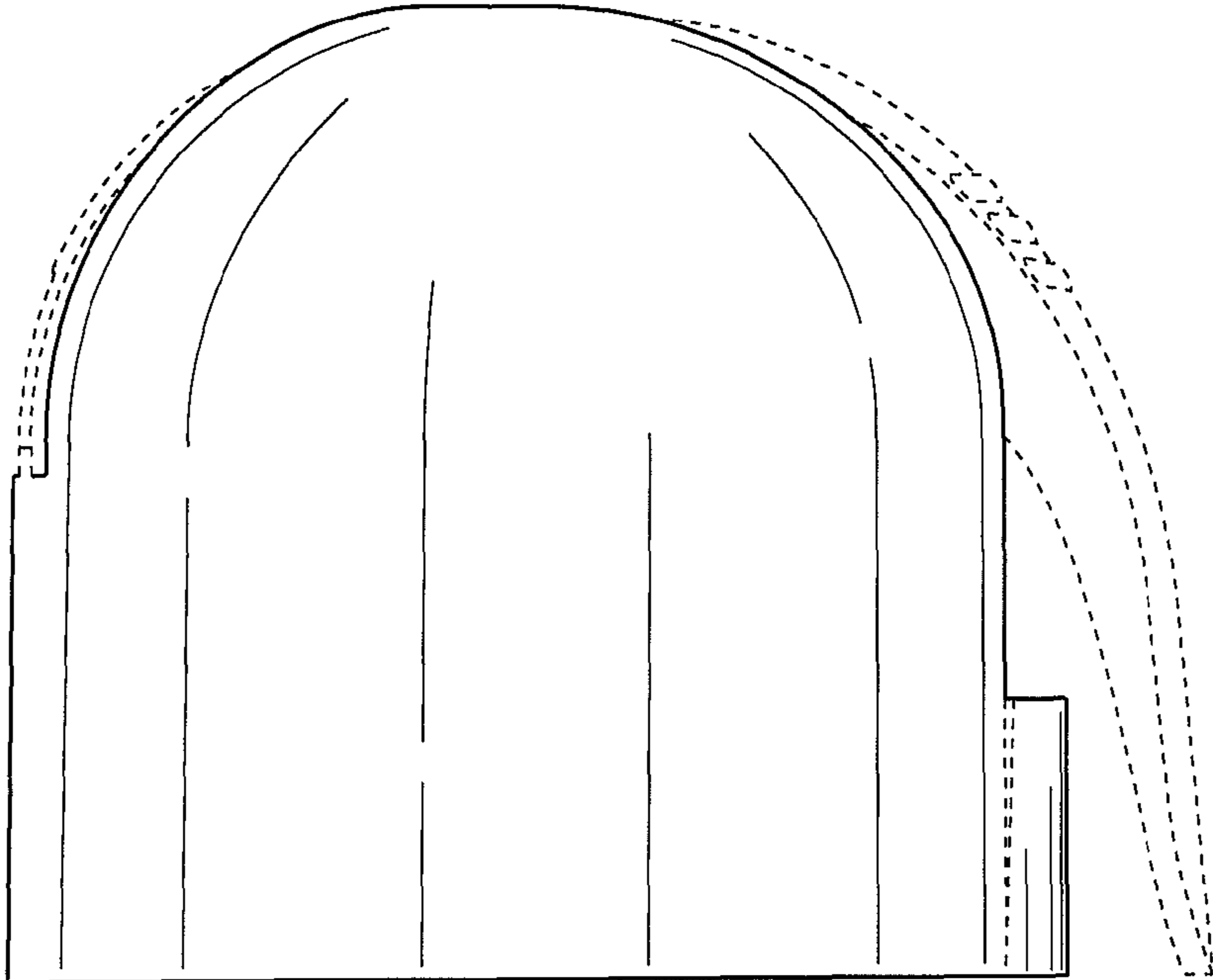

FIG. 2

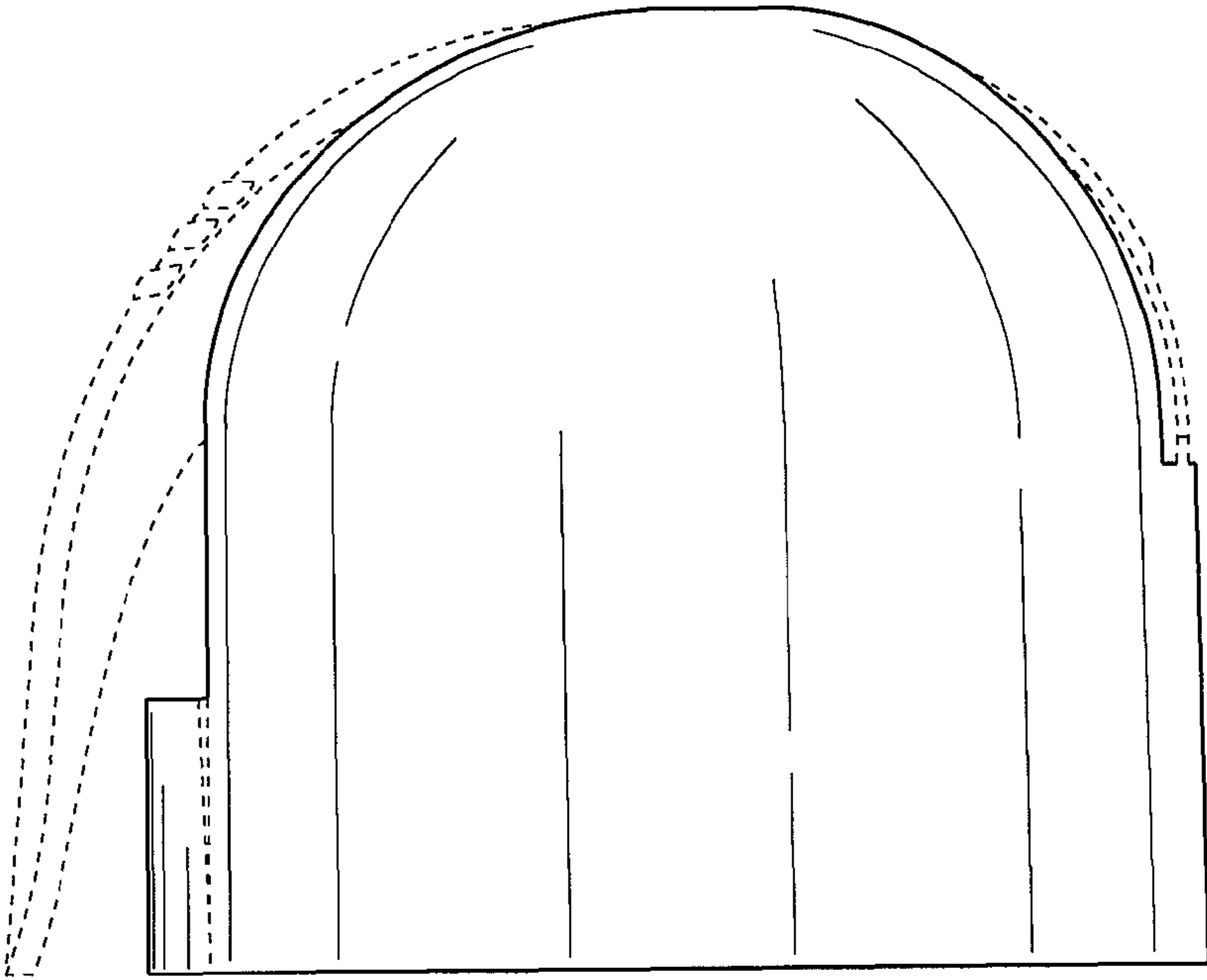

FIG. 3

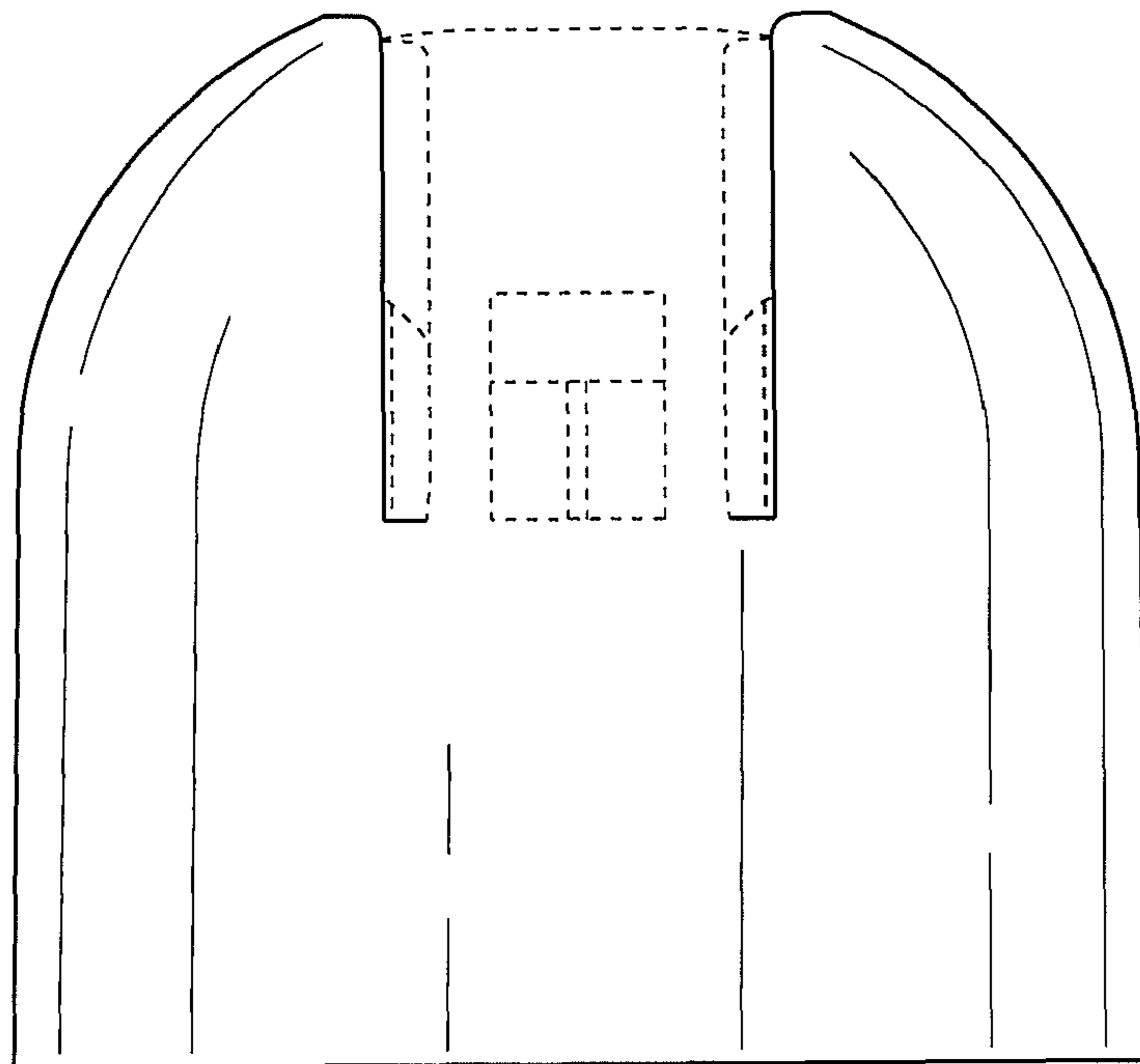

FIG. 4

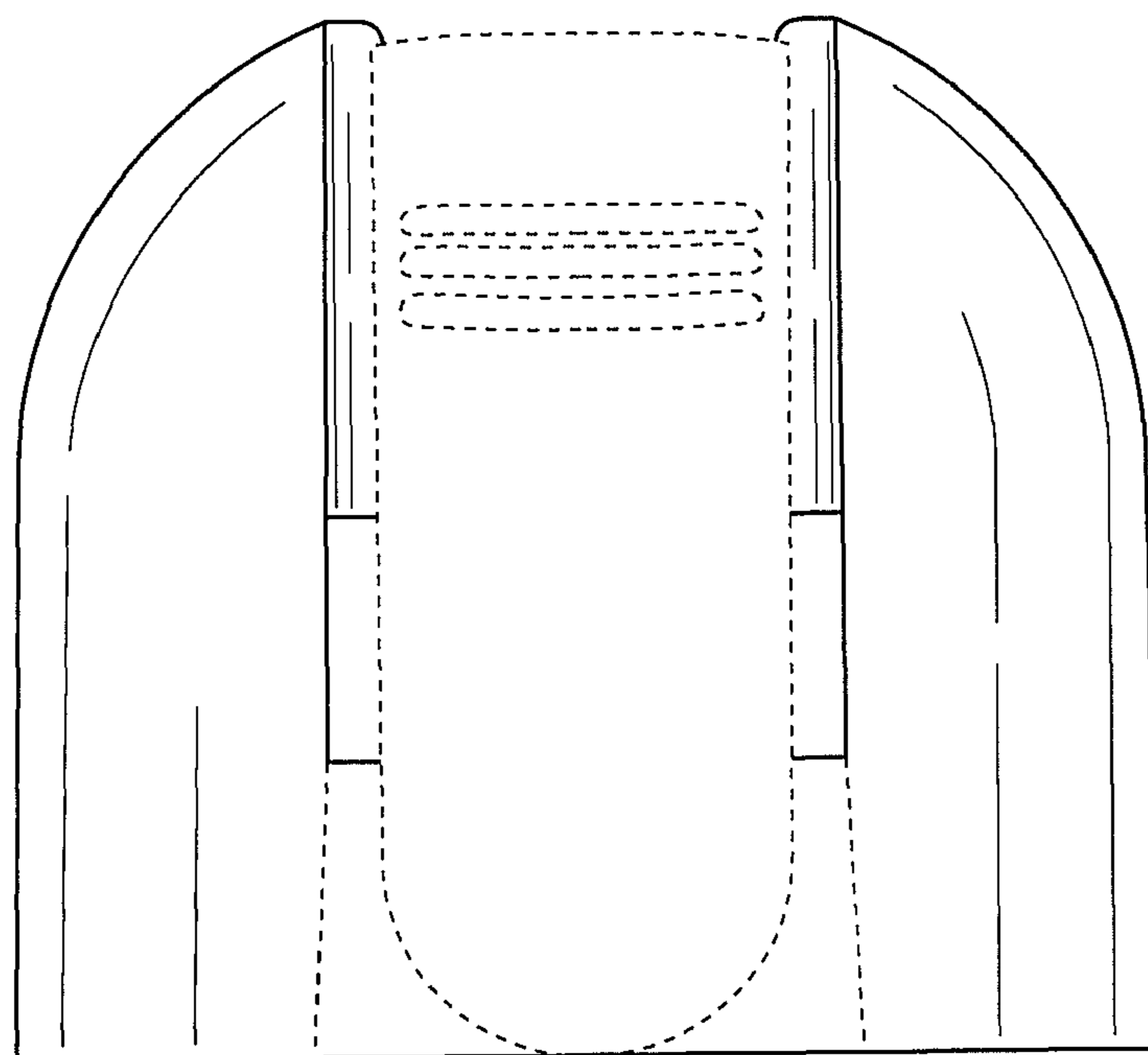

FIG. 5

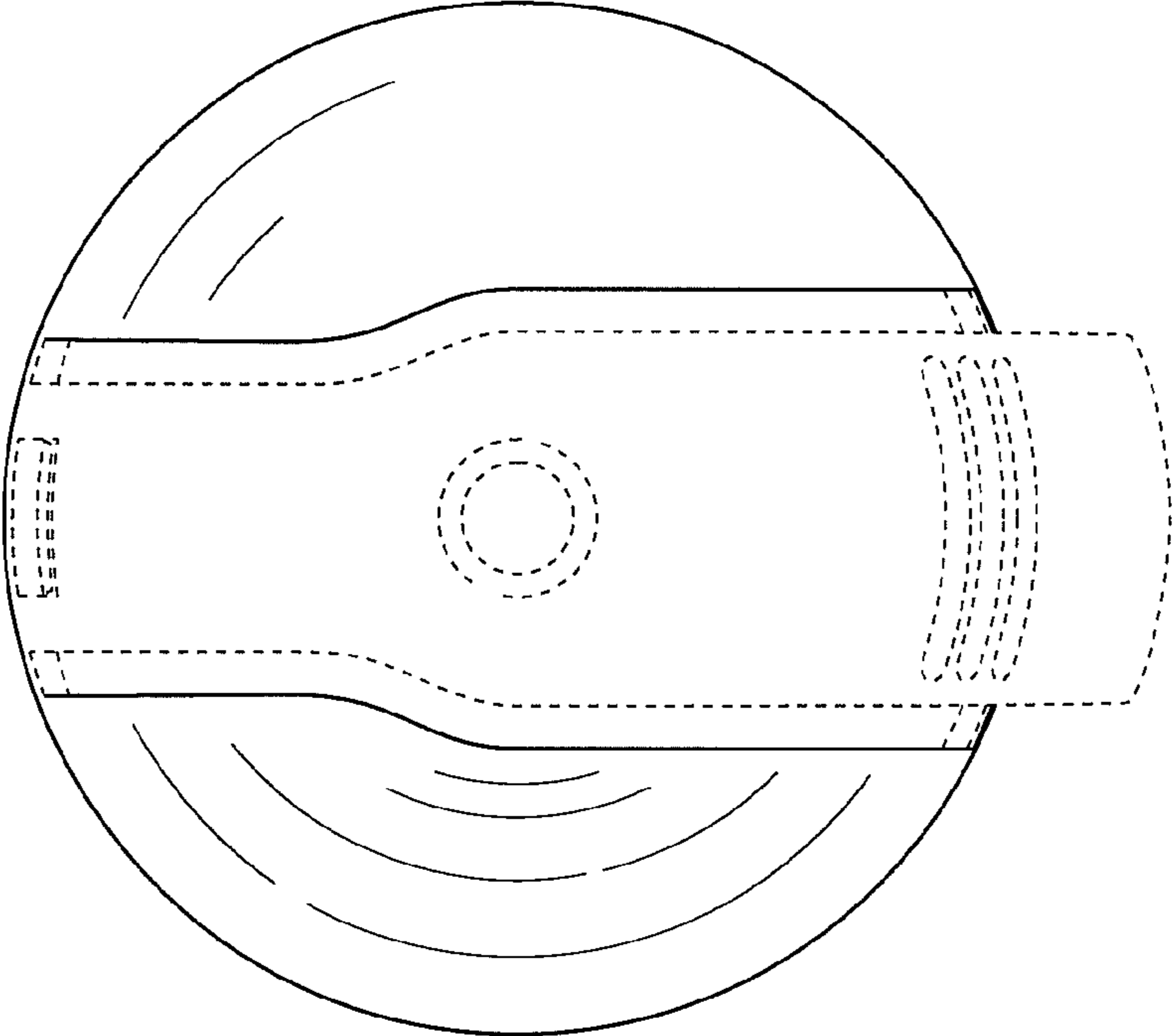

FIG. 6

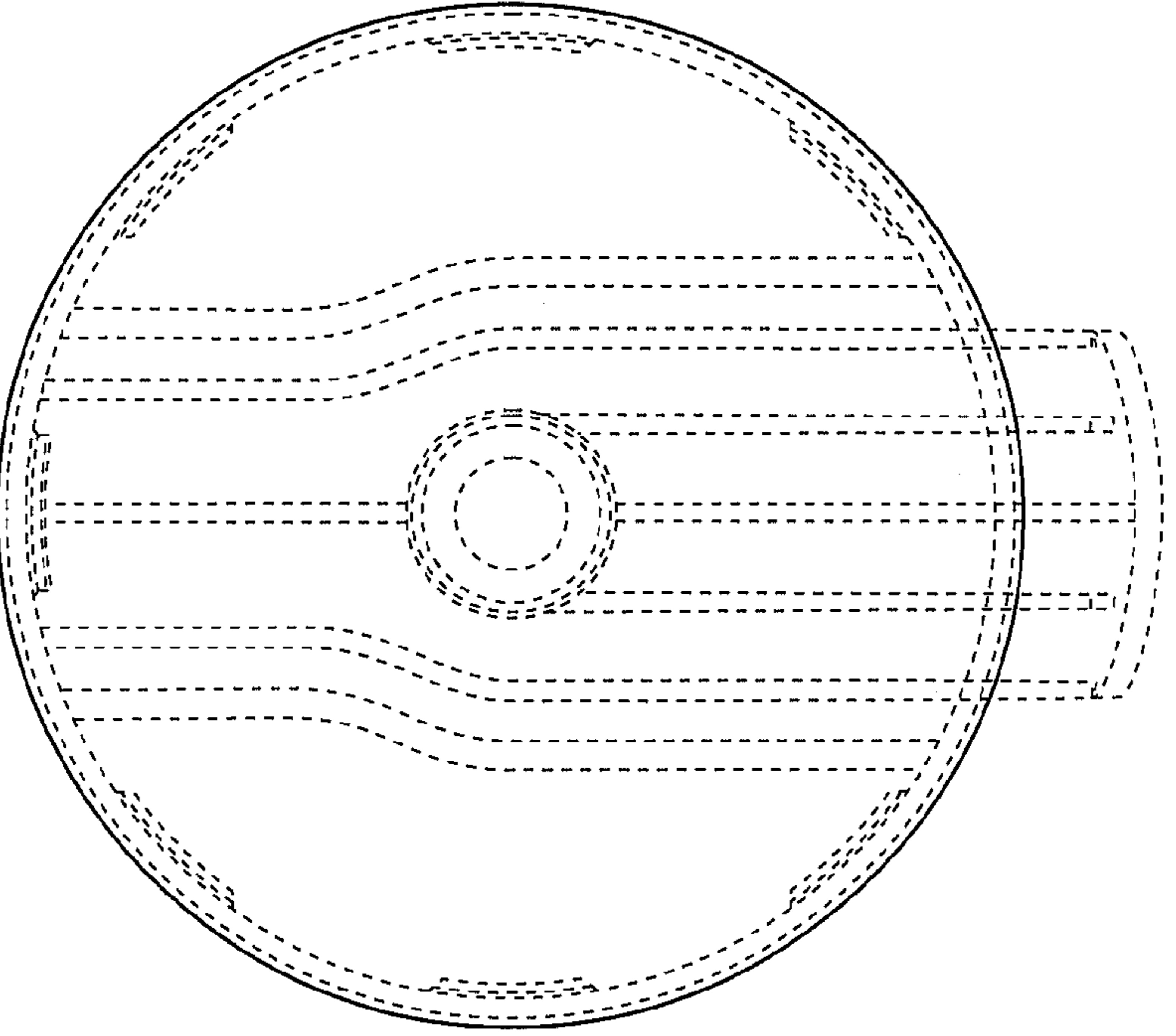

FIG. 7