



US00D627198S

(12) **United States Design Patent**
Hull et al.

(10) **Patent No.:** **US D627,198 S**

(45) **Date of Patent:** **** Nov. 16, 2010**

(54) **PINCH BOWL**

(75) Inventors: **David Hull**, Seattle, WA (US); **David A. Holcomb**, Seattle, WA (US)

(73) Assignee: **Chef'n Corporation**, Seattle, WA (US)

(**) Term: **14 Years**

(21) Appl. No.: **29/355,383**

(22) Filed: **Feb. 5, 2010**

(51) **LOC (9) Cl.** **07-01**

(52) **U.S. Cl.** **D7/587; D7/500**

(58) **Field of Classification Search** D7/587,
D7/500, 586, 566, 561, 560, 543, 629, 602,
D7/584, 615, 509, 316, 542, 545; D9/428,
D9/425, 429, 432; D10/46.2; 220/574, 676,
220/575; 229/406

See application file for complete search history.

(56) **References Cited**

U.S. PATENT DOCUMENTS

D43,852 S *	4/1913	Sanford	D7/565
D286,726 S *	11/1986	Daenen et al.	D7/587
5,082,135 A *	1/1992	DeCoster	220/694
D328,010 S *	7/1992	Daenen et al.	D7/591
D398,485 S *	9/1998	Landauer et al.	D7/629
D399,099 S *	10/1998	Cousins	D7/615
D452,635 S *	1/2002	Kortleven et al.	D7/538
D514,385 S *	2/2006	Smith et al.	D7/509

D544,298 S *	6/2007	Eide et al.	D7/396.1
D604,157 S *	11/2009	Reiterer et al.	D9/416
D612,752 S *	3/2010	Lee	D10/46.2
D613,124 S *	4/2010	Osborne	D7/555
2004/0045974 A1 *	3/2004	Gruber et al.	220/669

* cited by examiner

Primary Examiner—Robert M Spear

Assistant Examiner—Cynthia Underwood

(74) *Attorney, Agent, or Firm*—Seed IP Law Group PLLC

(57) **CLAIM**

The ornamental design for a pinch bowl, as shown and described.

DESCRIPTION

FIG. 1 is a perspective view of a pinch bowl showing our new design.

FIG. 2 is a top plan view thereof.

FIG. 3 is a front elevational view thereof.

FIG. 4 is a rear elevational view thereof.

FIG. 5 is a bottom elevational view thereof.

FIG. 6 is a right side elevational view thereof; and,

FIG. 7 is a left side elevational view thereof.

The broken lines in the figures are for illustrative purposes only and form no part of the claimed design.

1 Claim, 4 Drawing Sheets

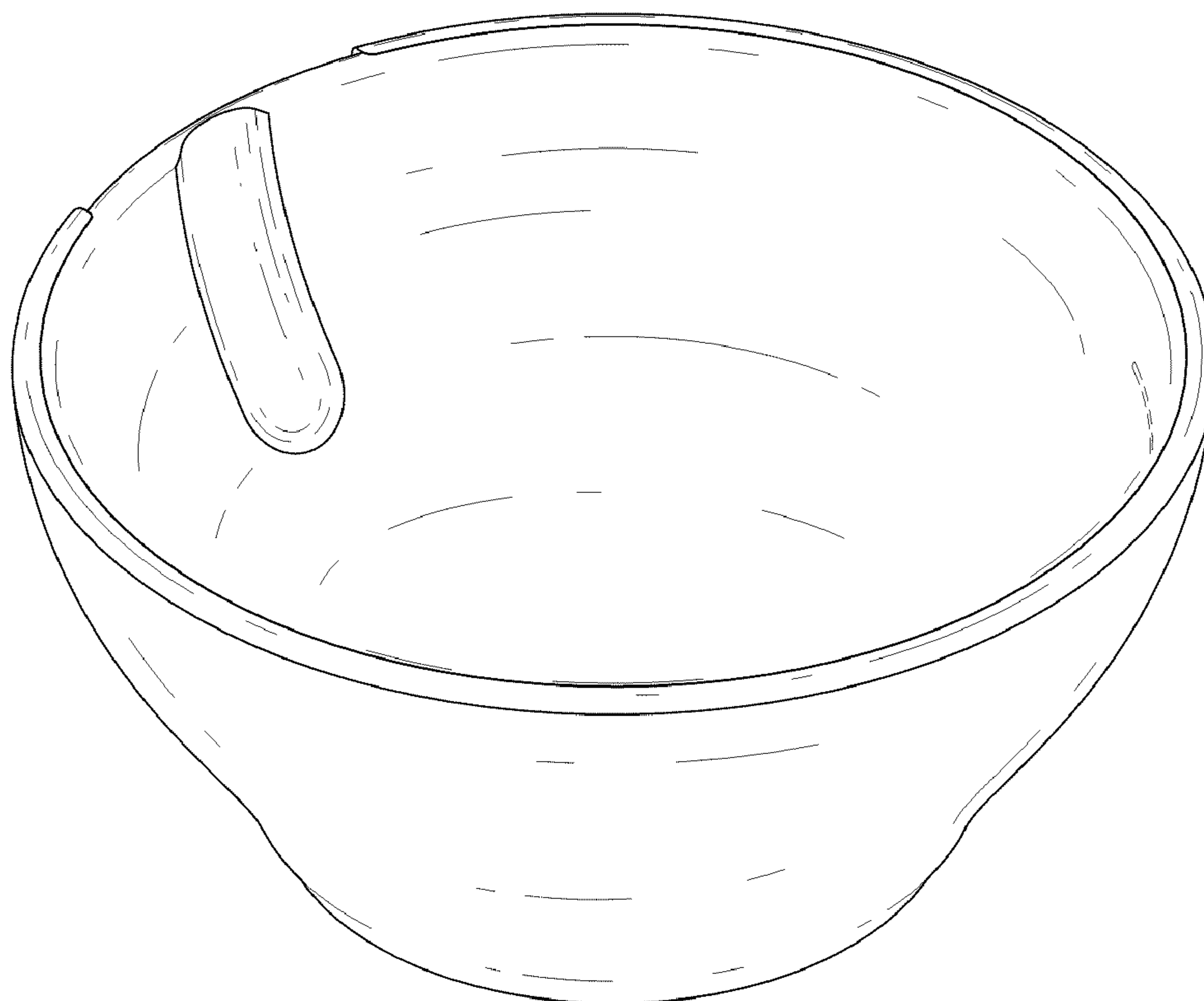

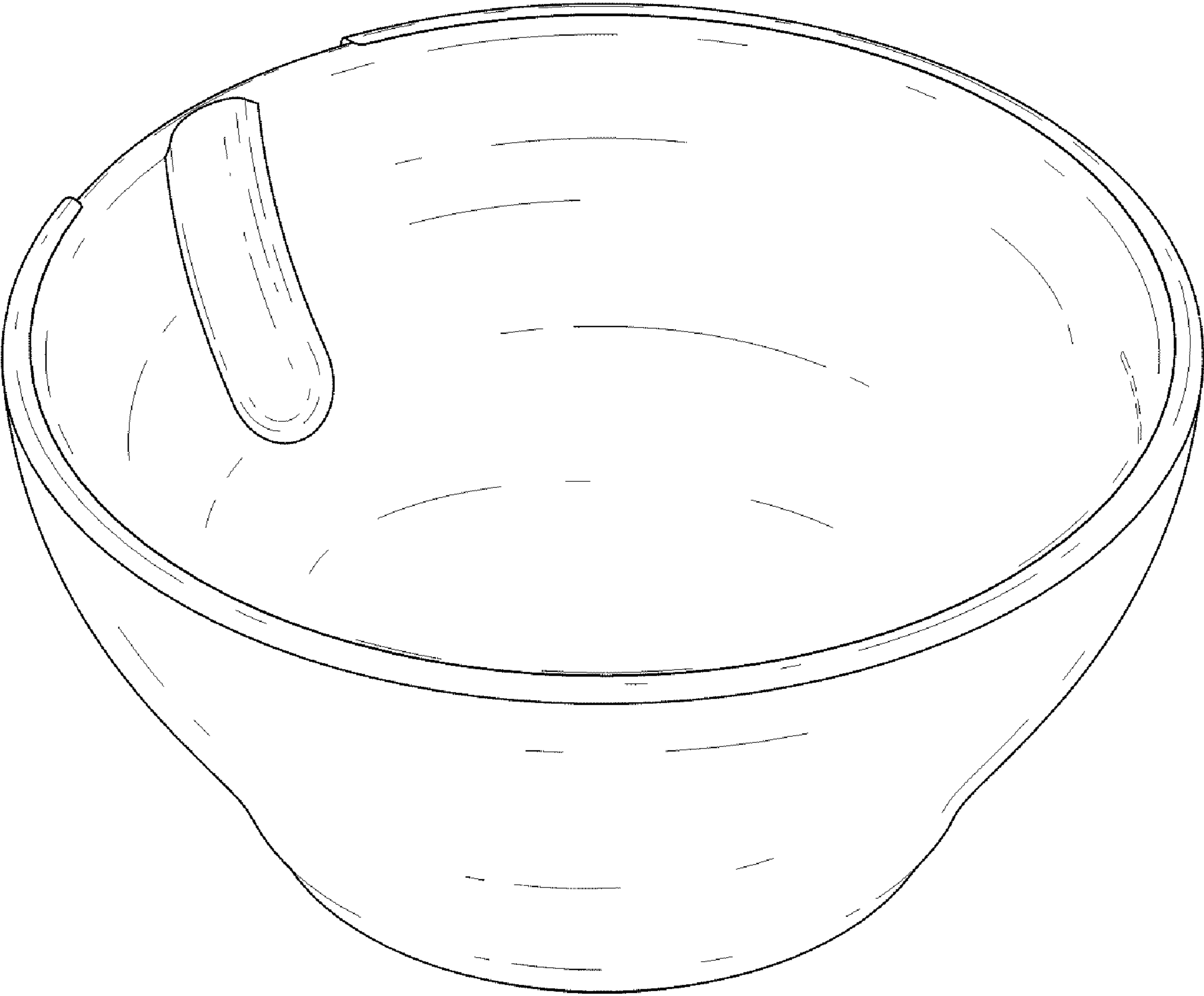

FIG. 1

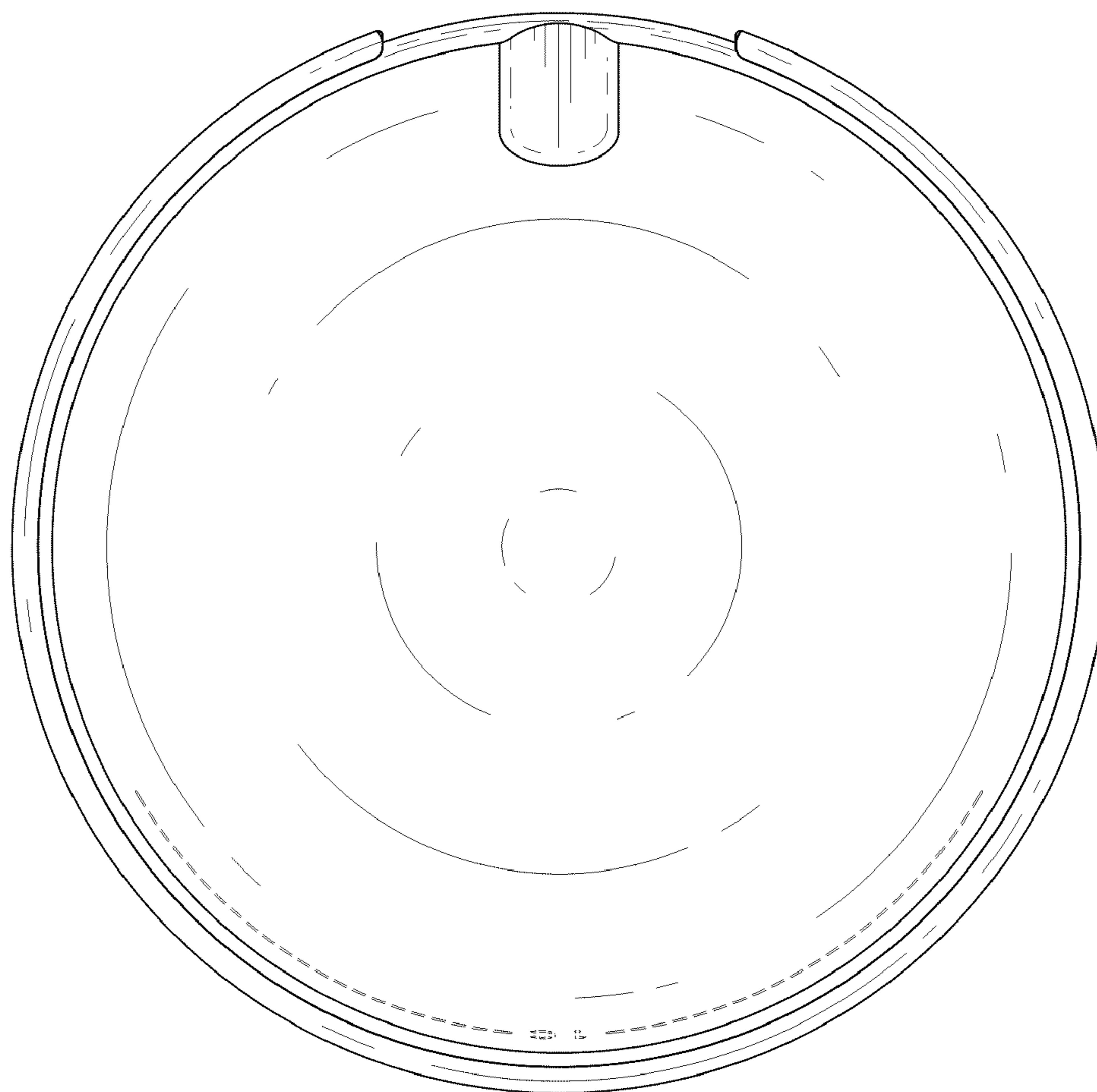

FIG. 2

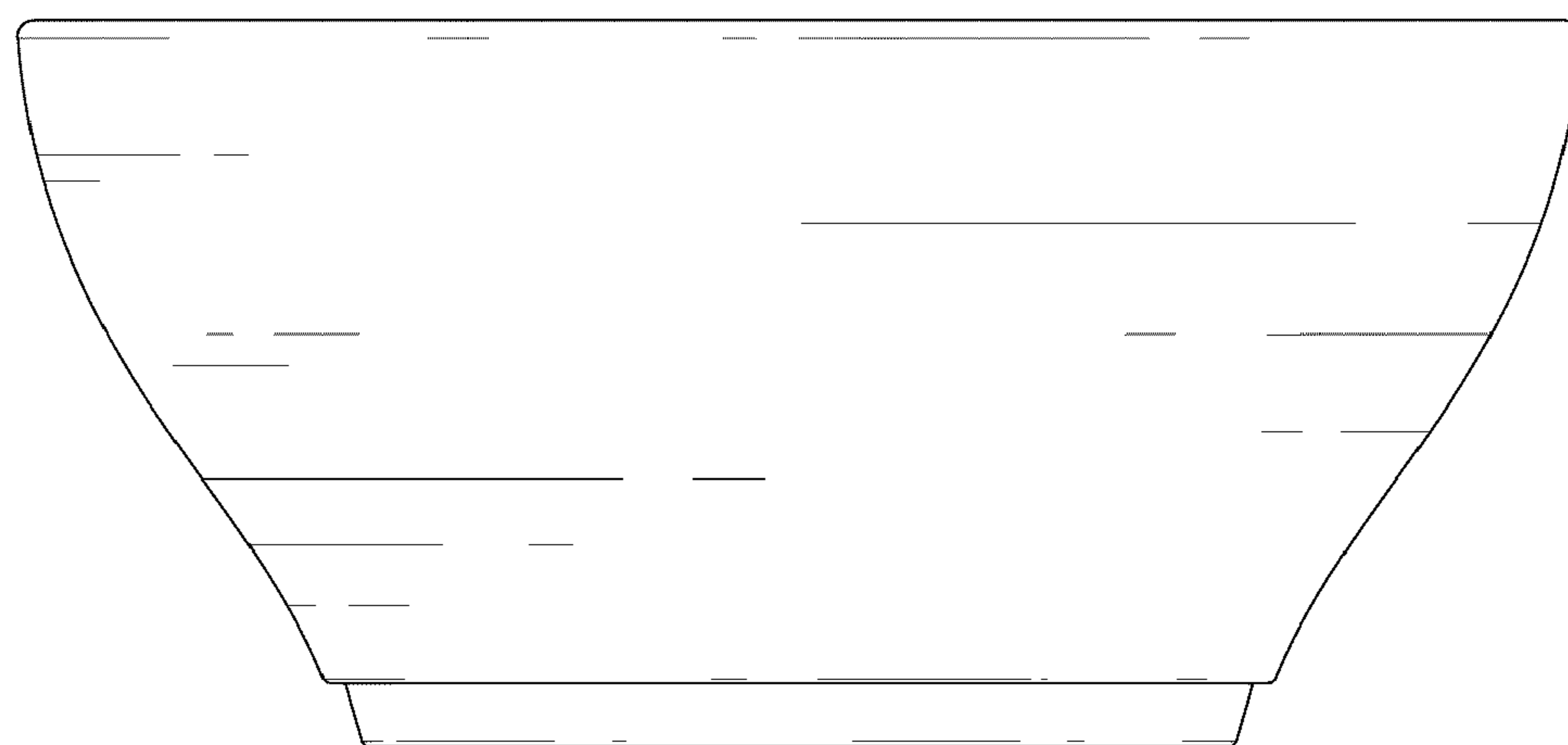

FIG. 3

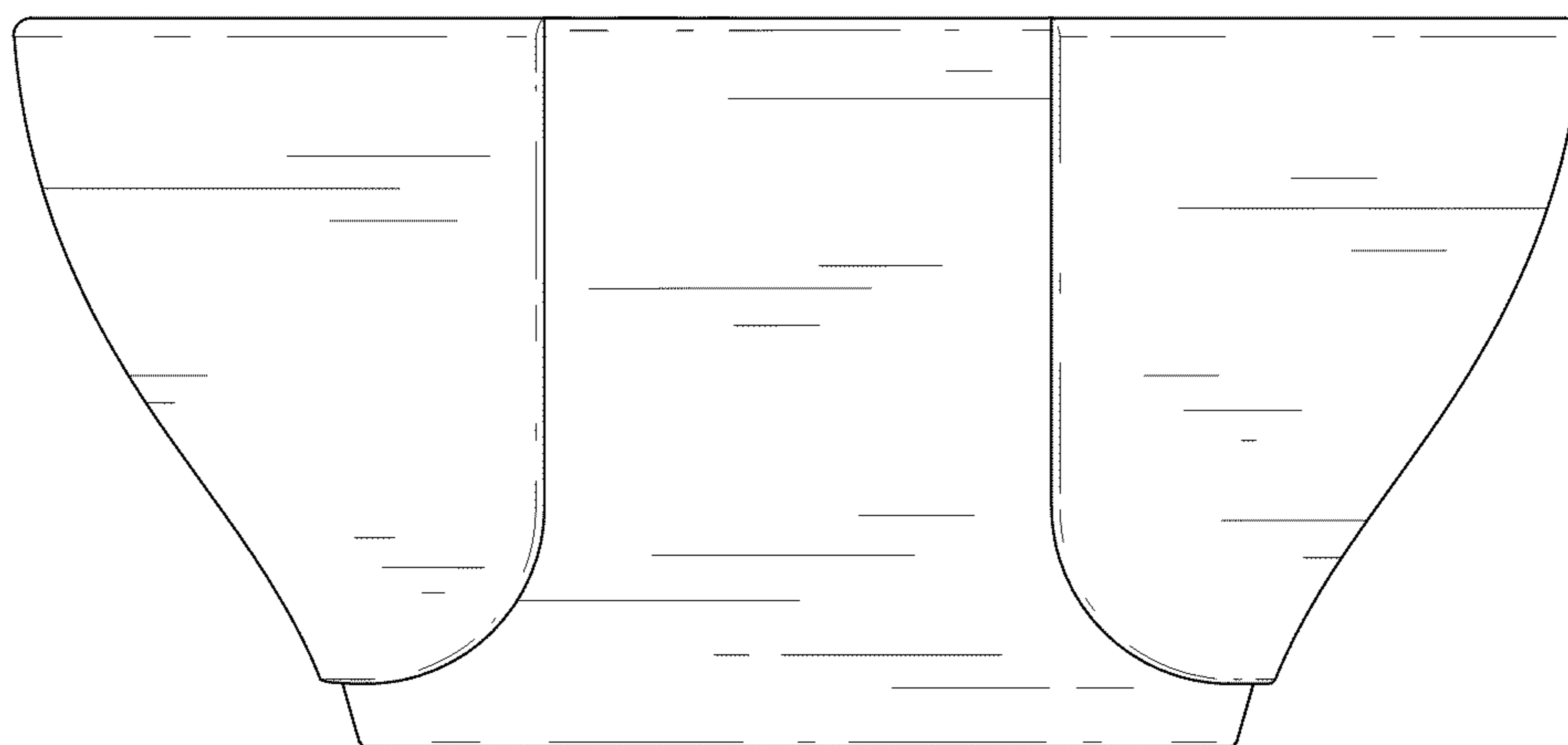

FIG. 4

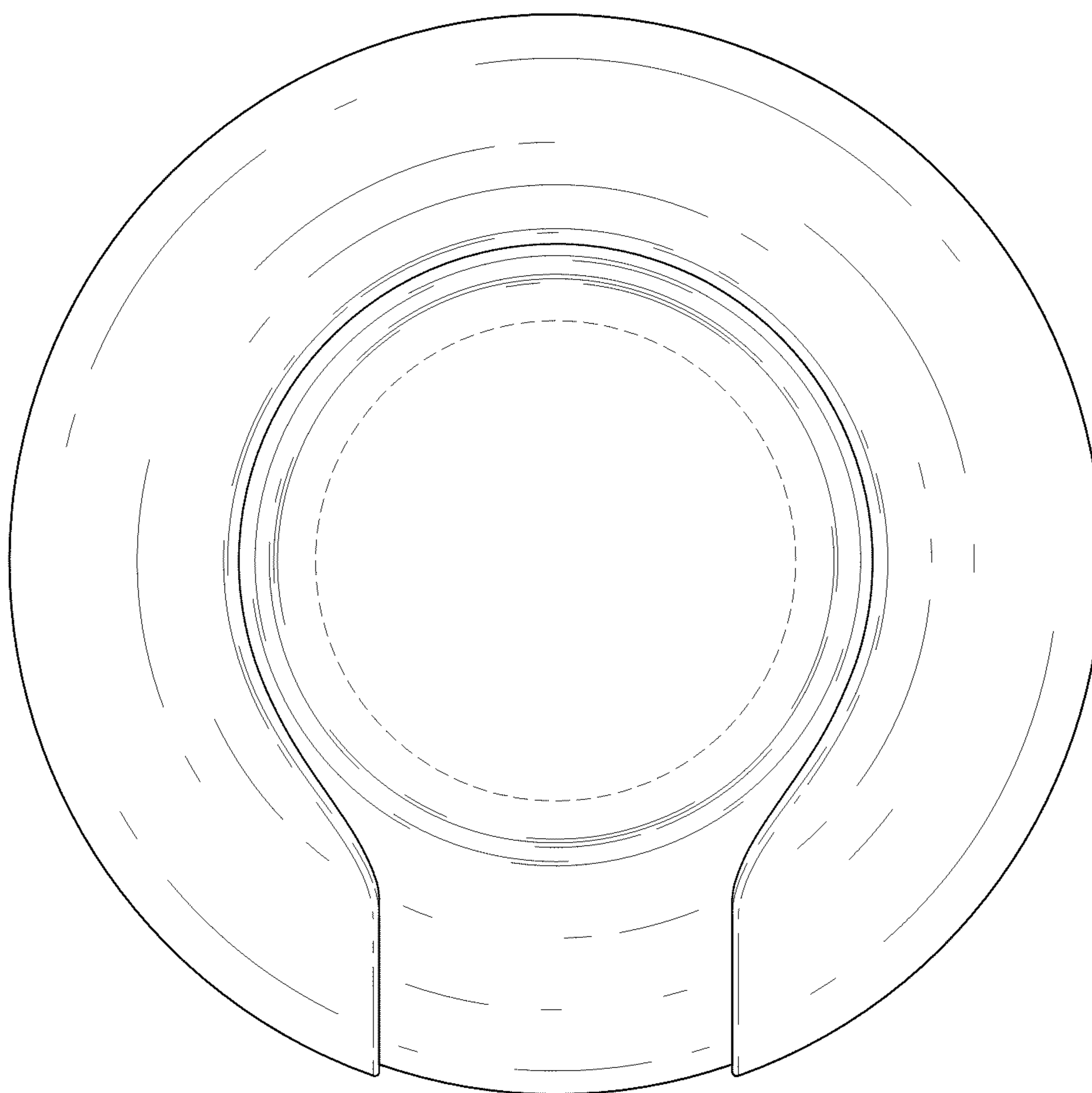

FIG. 5

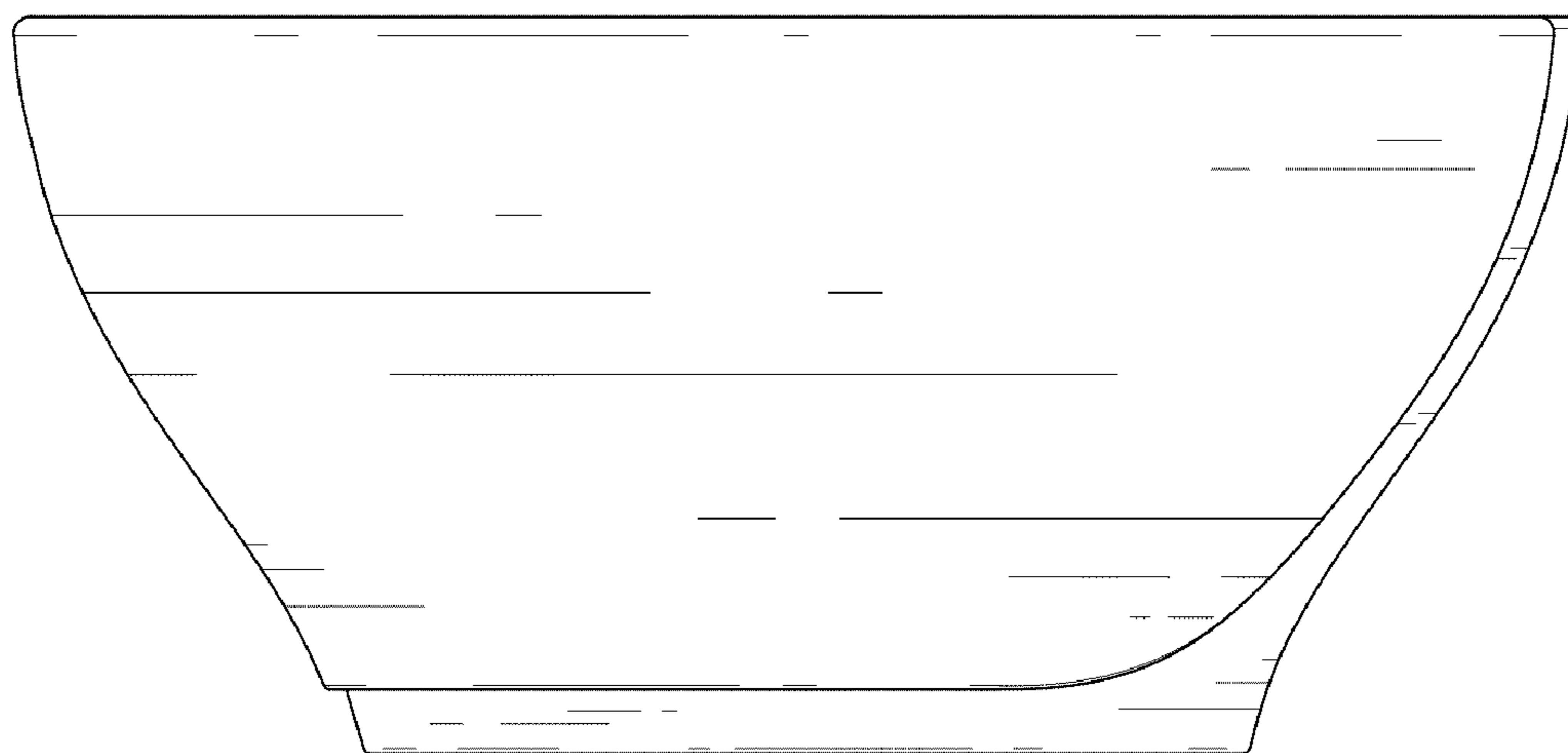

FIG. 6

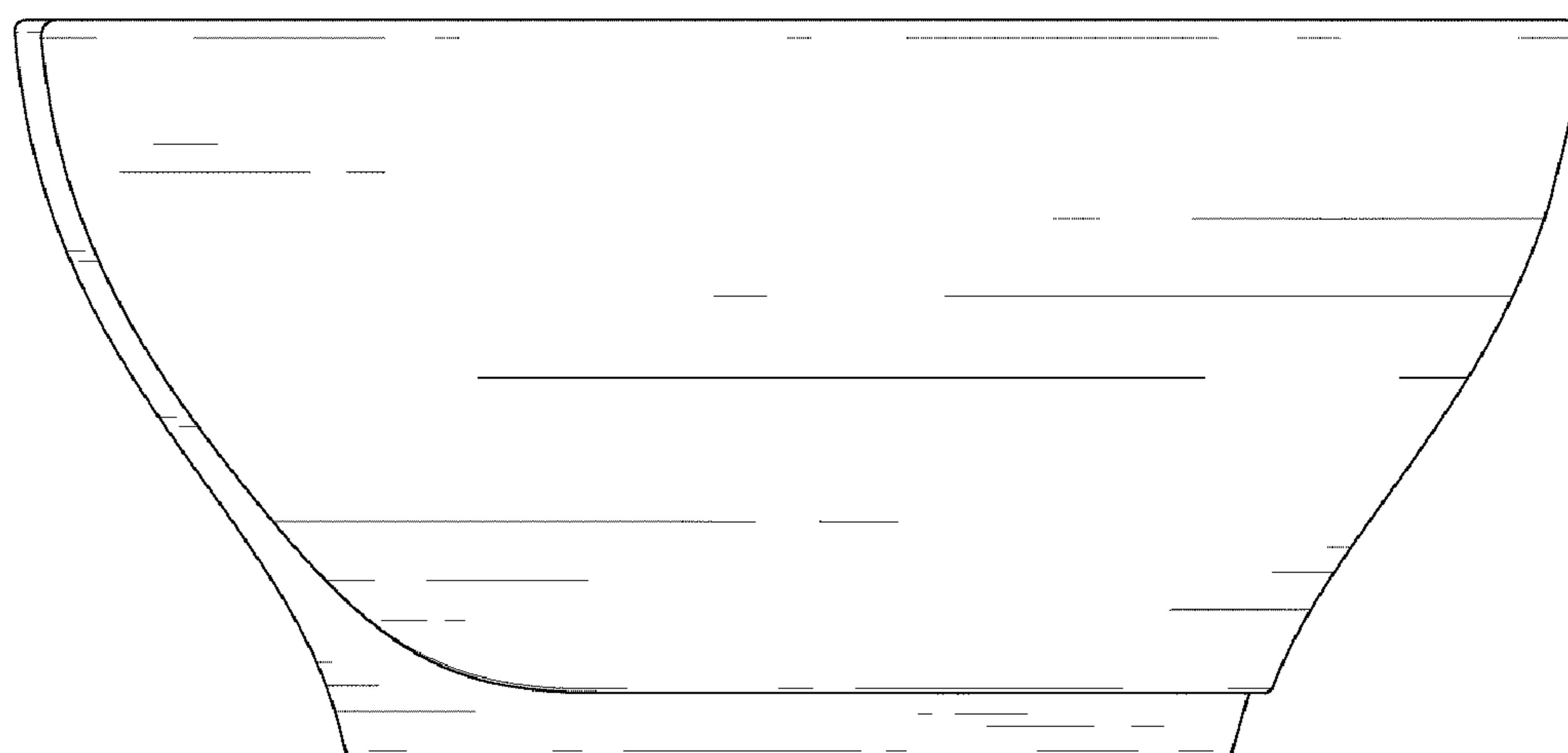

FIG. 7