



US00D627153S

(12) **United States Design Patent**
Schmidt et al.

(10) **Patent No.:** **US D627,153 S**

(45) **Date of Patent:** **** Nov. 16, 2010**

(54) **KEY FOB FOR MAGNETIC KEY LOCK**

D551,852 S * 10/2007 Oas D3/209

(75) Inventors: **Laurie Schmidt**, Dallas, TX (US); **John Wiseman**, Lewisville, TX (US)

* cited by examiner

Primary Examiner—Ralf Seifert

(73) Assignee: **Sports Solutions, Inc.**, Dallas, TX (US)

(74) *Attorney, Agent, or Firm*—Howison & Arnott, L.L.P.

(**) Term: **14 Years**

(57) **CLAIM**

(21) Appl. No.: **29/354,903**

The ornamental design for a key fob for a magnetic key lock, as shown.

(22) Filed: **Jan. 29, 2010**

DESCRIPTION

(51) **LOC (9) Cl.** **03-01**

FIG. 1 illustrates a front perspective view of a key fob;

(52) **U.S. Cl.** **D3/207**

FIG. 2 illustrates a front view of the key fob;

(58) **Field of Classification Search** D11/1-2,
D11/14, 26-29, 89-92, 44, 48, 81, 99; 63/26-28;
D3/207-212; D8/38, 330, 331, 347; 70/456 B;
206/37.1

FIG. 3 illustrates a rear view of the key fob;

FIG. 4 illustrates a left side view of the key fob;

FIG. 5 illustrates a top view of the key fob; and,

FIG. 6 illustrates a right side view of the key fob.

See application file for complete search history.

The broken lines in FIGS. 1, 2, 4 and 6 are included for the purpose of illustrating environmental matter and form no part of the claimed design.

(56) **References Cited**

U.S. PATENT DOCUMENTS

D501,781 S * 2/2005 Galli D8/99

1 Claim, 5 Drawing Sheets

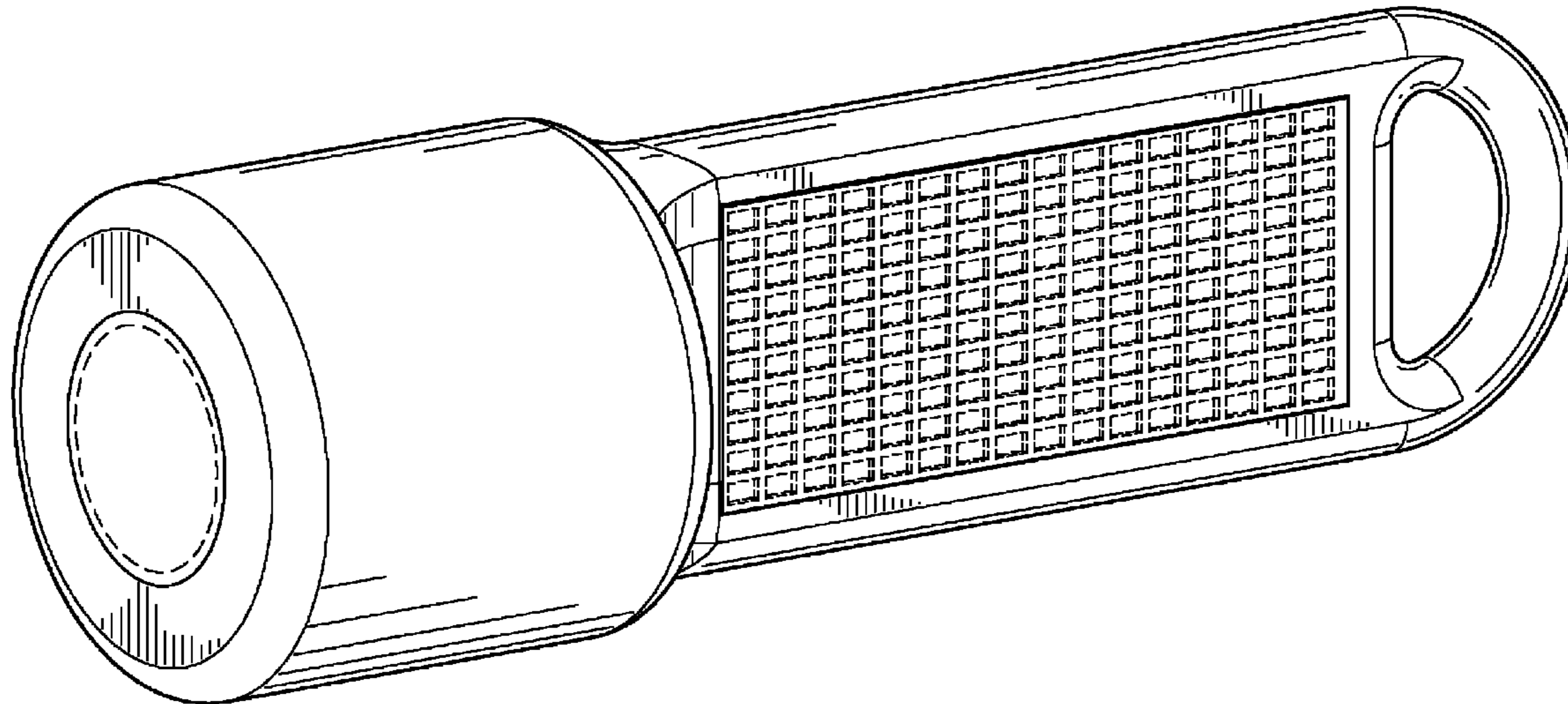

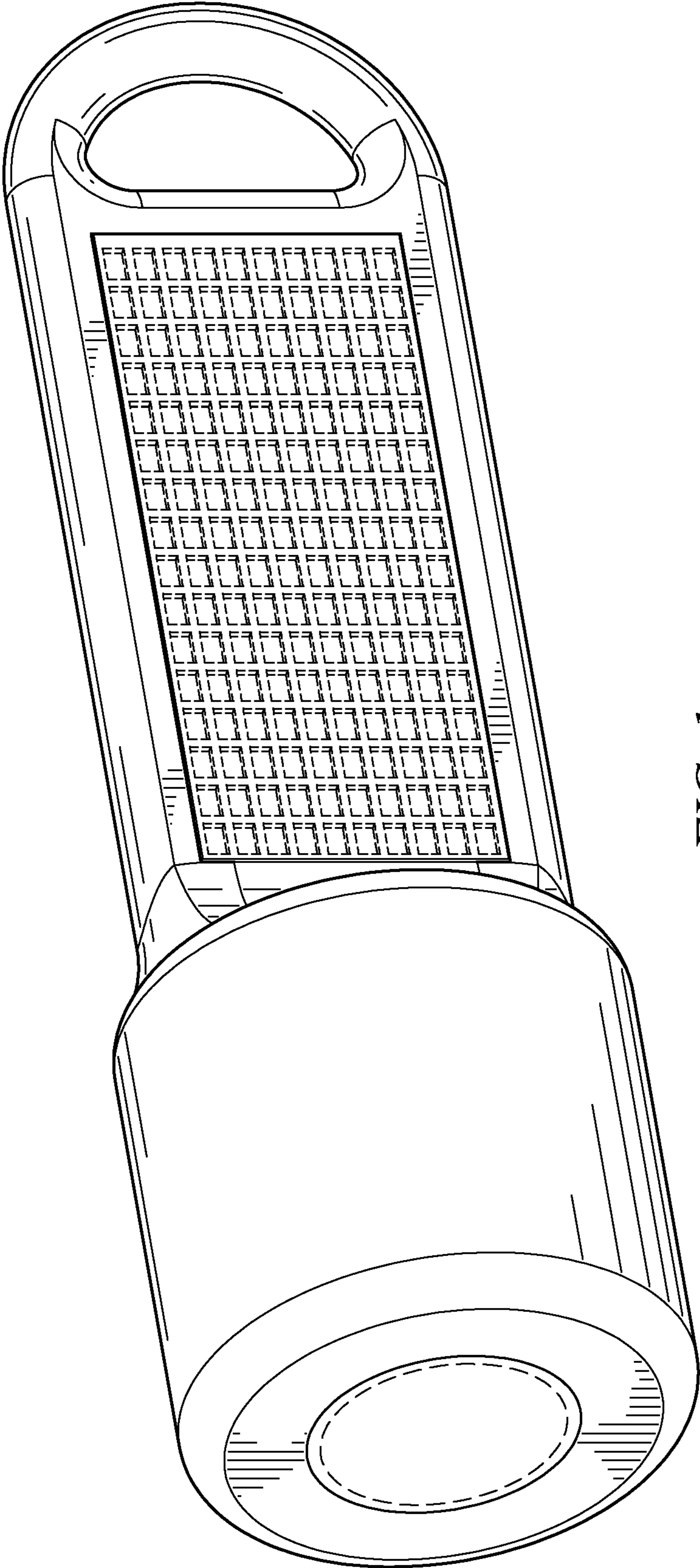

FIG. 1

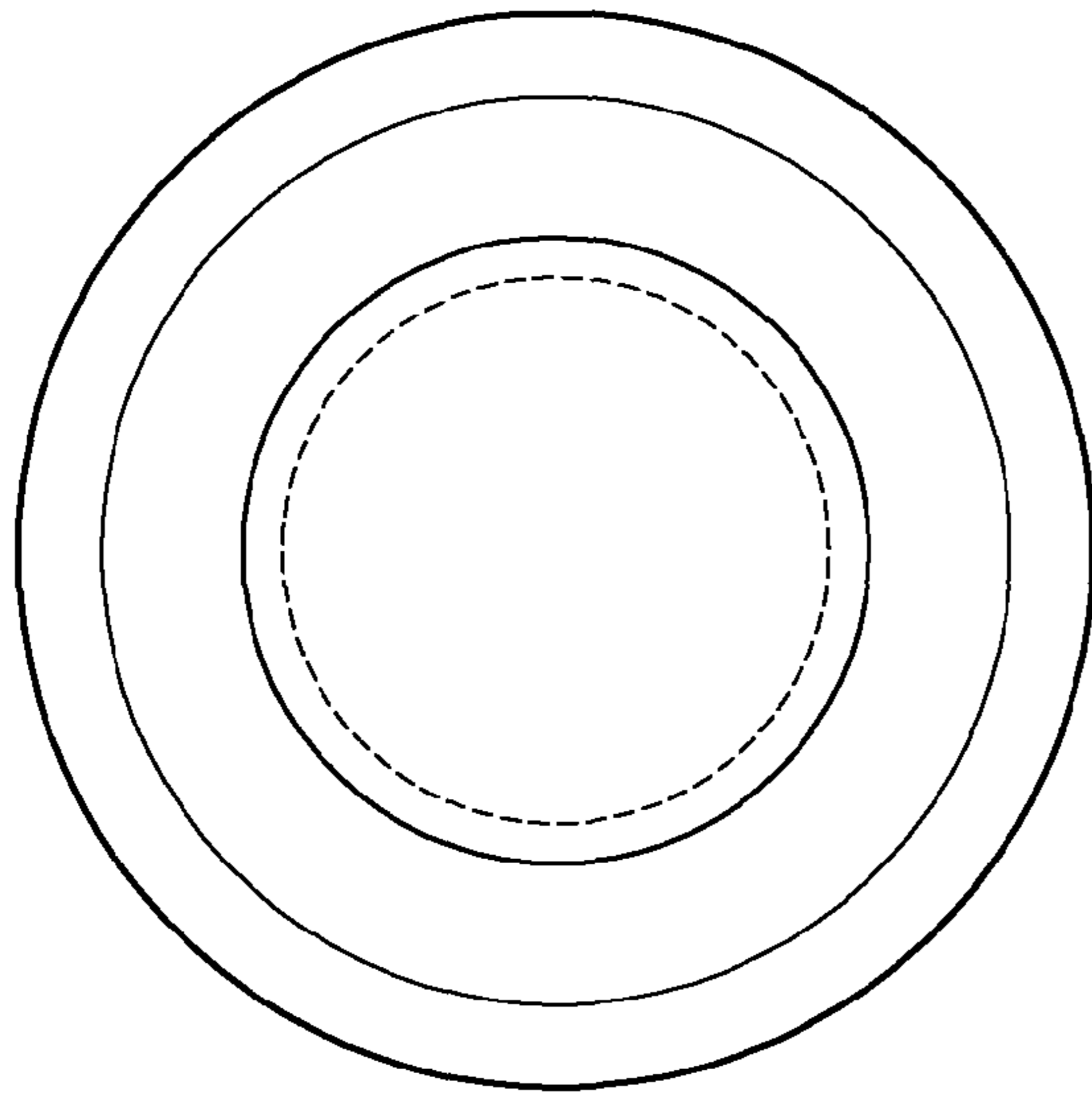

FIG. 2

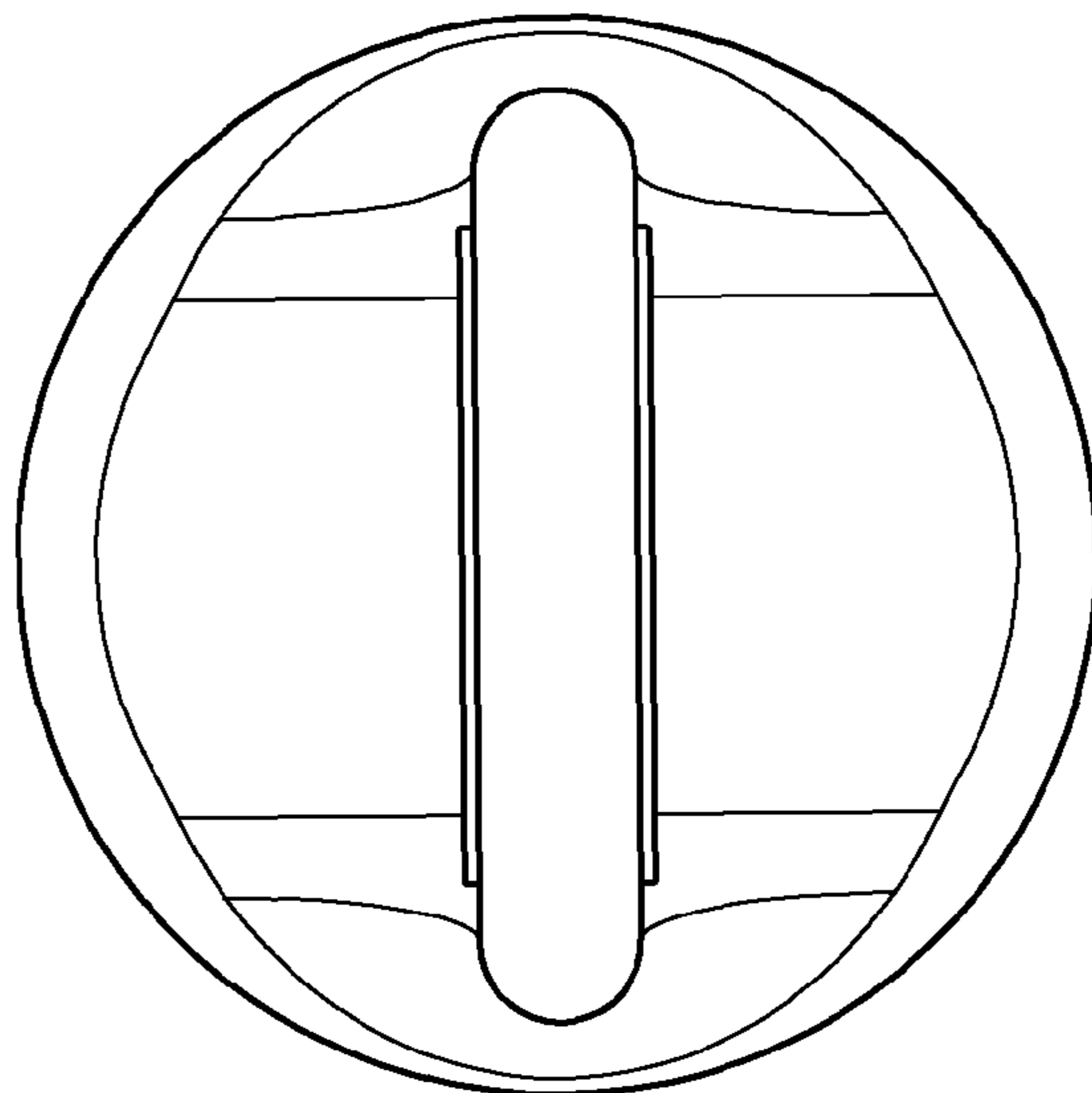

FIG. 3

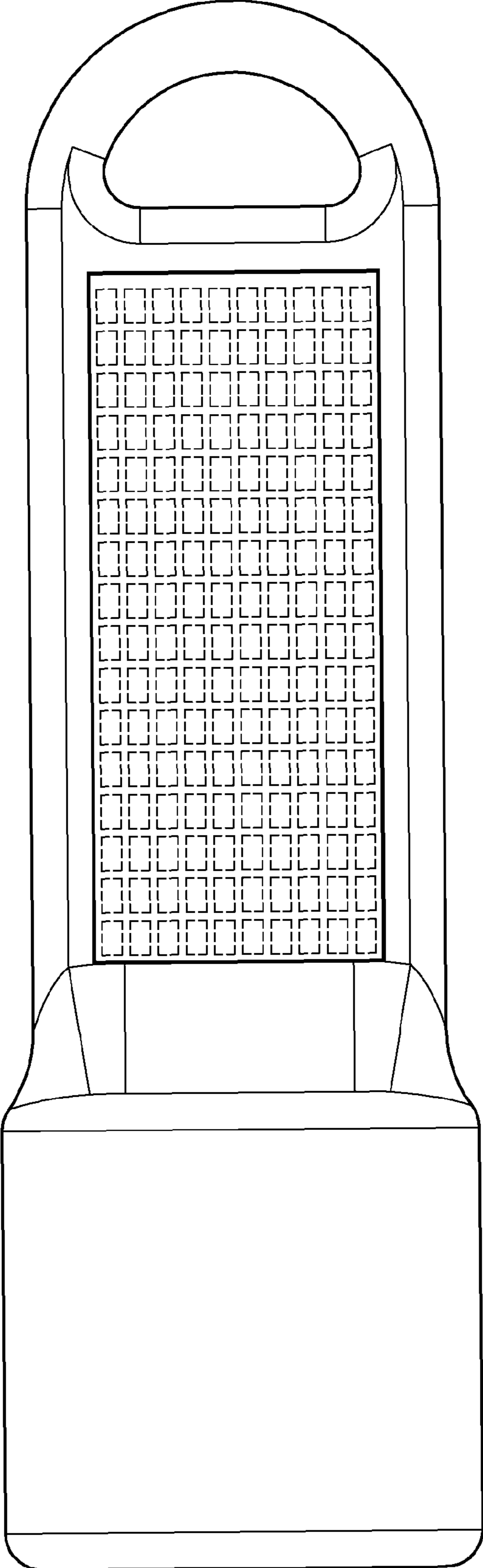

FIG. 4

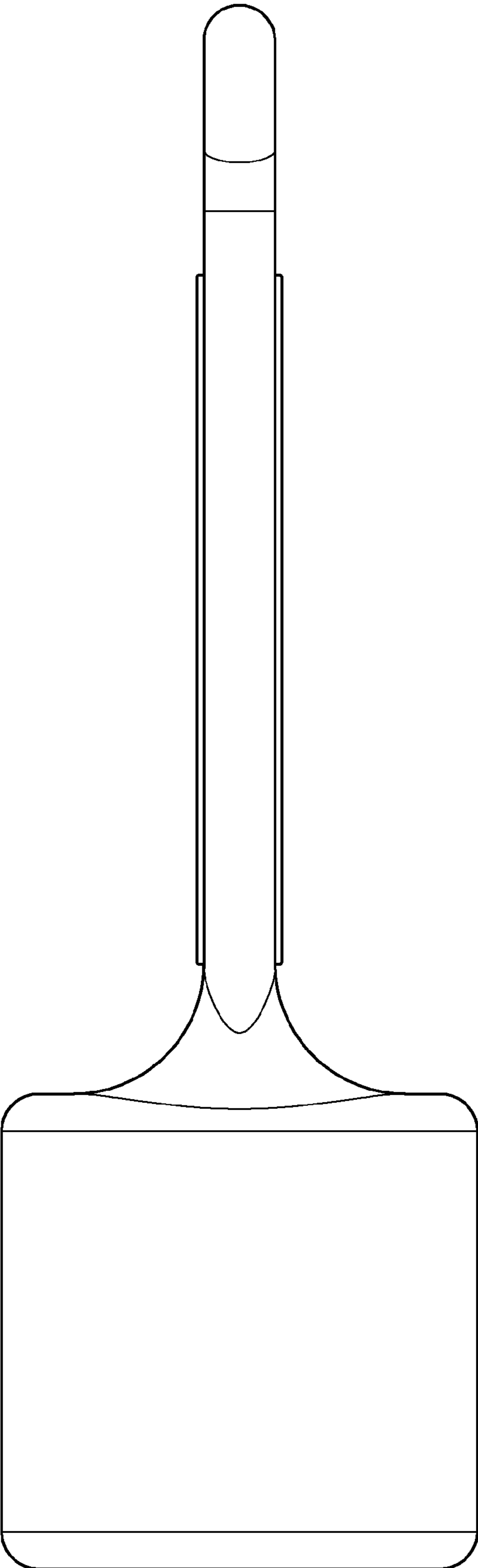

FIG. 5

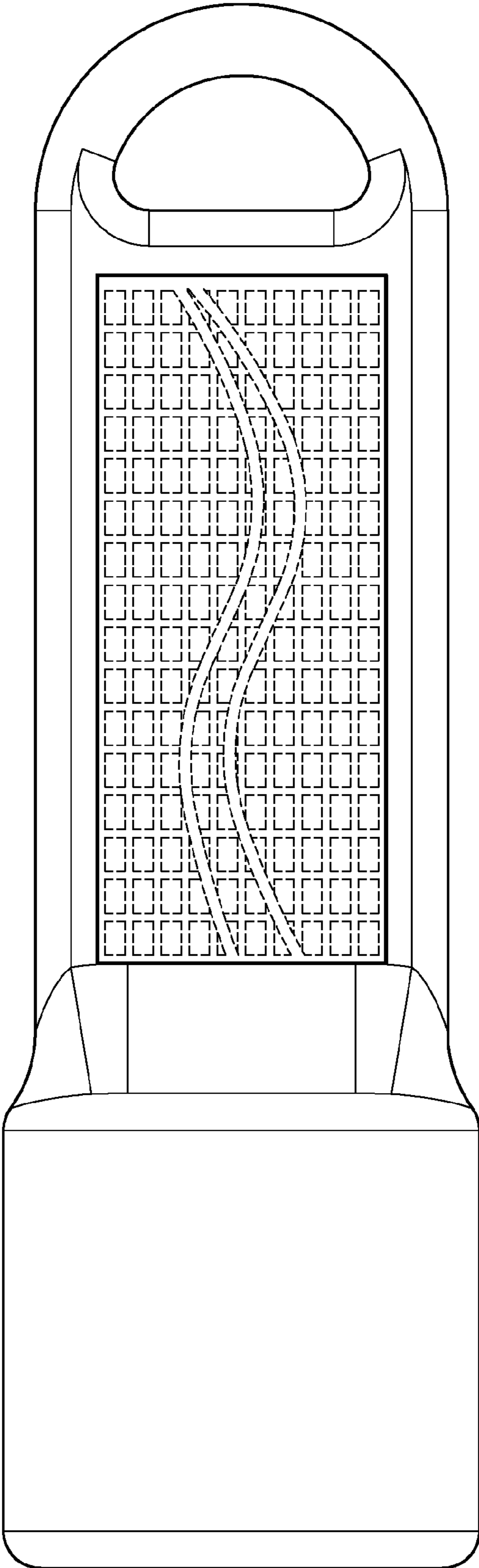

FIG. 6