



US00D627123S

(12) **United States Design Patent**
Schöniger

(10) **Patent No.:** **US D627,123 S**

(45) **Date of Patent:** **** Nov. 9, 2010**

(54) **DEVICE FOR HOLDING SACKS AND BAGS OPEN**

(57) **CLAIM**

The ornamental design for a device for holding sacks and bags open, as shown and described.

(75) Inventor: **Reinhard Schöniger**, Numana (IT)

(73) Assignee: **Italia Stampa s.r.l.** (IT)

(**) Term: **14 Years**

(21) Appl. No.: **29/282,063**

(22) Filed: **Jul. 10, 2007**

(30) **Foreign Application Priority Data**

Jan. 10, 2007	(EM)	000649470-0001
Jan. 10, 2007	(EM)	000649470-0002
Jan. 10, 2007	(EM)	000649470-0003
Jan. 10, 2007	(EM)	000649470-0004
Jan. 10, 2007	(EM)	000649470-0005

(51) **LOC (9) Cl.** **09-09**

(52) **U.S. Cl.** **D34/6**

(58) **Field of Classification Search** D34/1,
D34/5, 6, 7, 8, 9, 10, 11; 220/908-913; 248/95,
248/99, 100, 101

See application file for complete search history.

(56) **References Cited**

U.S. PATENT DOCUMENTS

4,832,292	A *	5/1989	Beckham	248/99
5,030,948	A *	7/1991	Rush	340/7.46
D404,184	S *	1/1999	Berrios	D34/6
6,068,221	A *	5/2000	Rosen	248/99
6,915,921	B2 *	7/2005	Mensch	220/212
2008/0023596	A1 *	1/2008	Schoniger	248/99

* cited by examiner

Primary Examiner—Cynthia E Ramirez

(74) *Attorney, Agent, or Firm*—Robert W. Becker & Assoc.;
Robert W. Becker

DESCRIPTION

FIG. 1 is a front view for a device for holding sacks and bags open showing my design;

FIG. 2 is a perspective view with the spikes folded down;

FIG. 3 is a perspective view with the cover folded down;

FIG. 4 is another perspective view thereof;

FIG. 5 is a side view with the cover folded down;

FIG. 6 is a side view thereof;

FIG. 7 is a top plan view with the cover folded down;

FIG. 8 is a rear view thereof;

FIG. 9 is a bottom view thereof;

FIG. 10 is a top plan view of a second embodiment;

FIG. 11 is a front view thereof;

FIG. 12 is a perspective view thereof;

FIG. 13 is a rear view thereof;

FIG. 14 is a side view thereof;

FIG. 15 is a bottom view thereof;

FIG. 16 is a perspective view of a third embodiment;

FIG. 17 is a perspective view with the cover folded down thereof;

FIG. 18 is a rear view thereof; and,

FIG. 19 is a bottom view thereof.

The broken line showing in the figures is included for the purpose of illustrating portions of the device and forms no part of the claimed design.

1 Claim, 19 Drawing Sheets

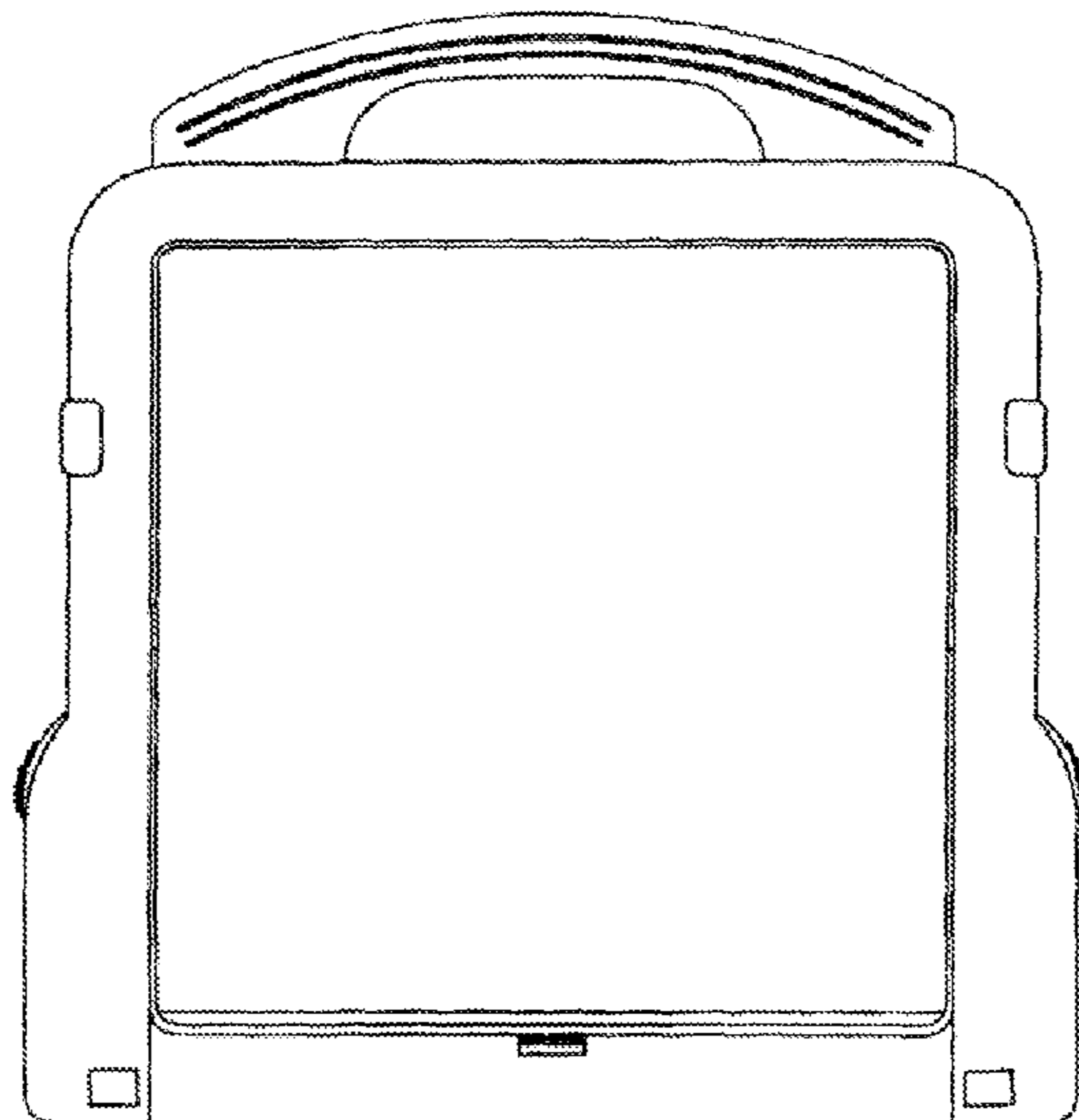

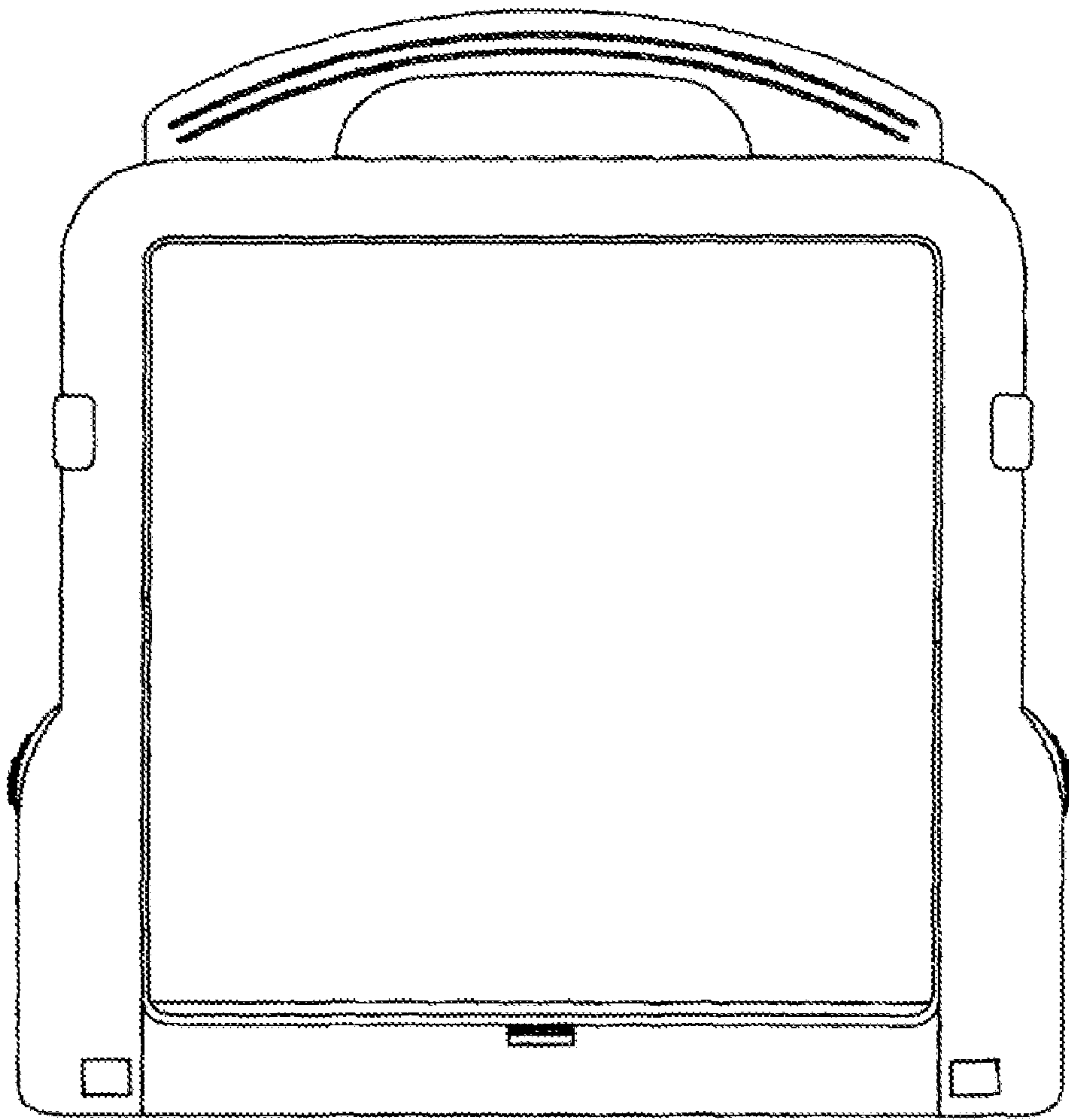

FIG. 1

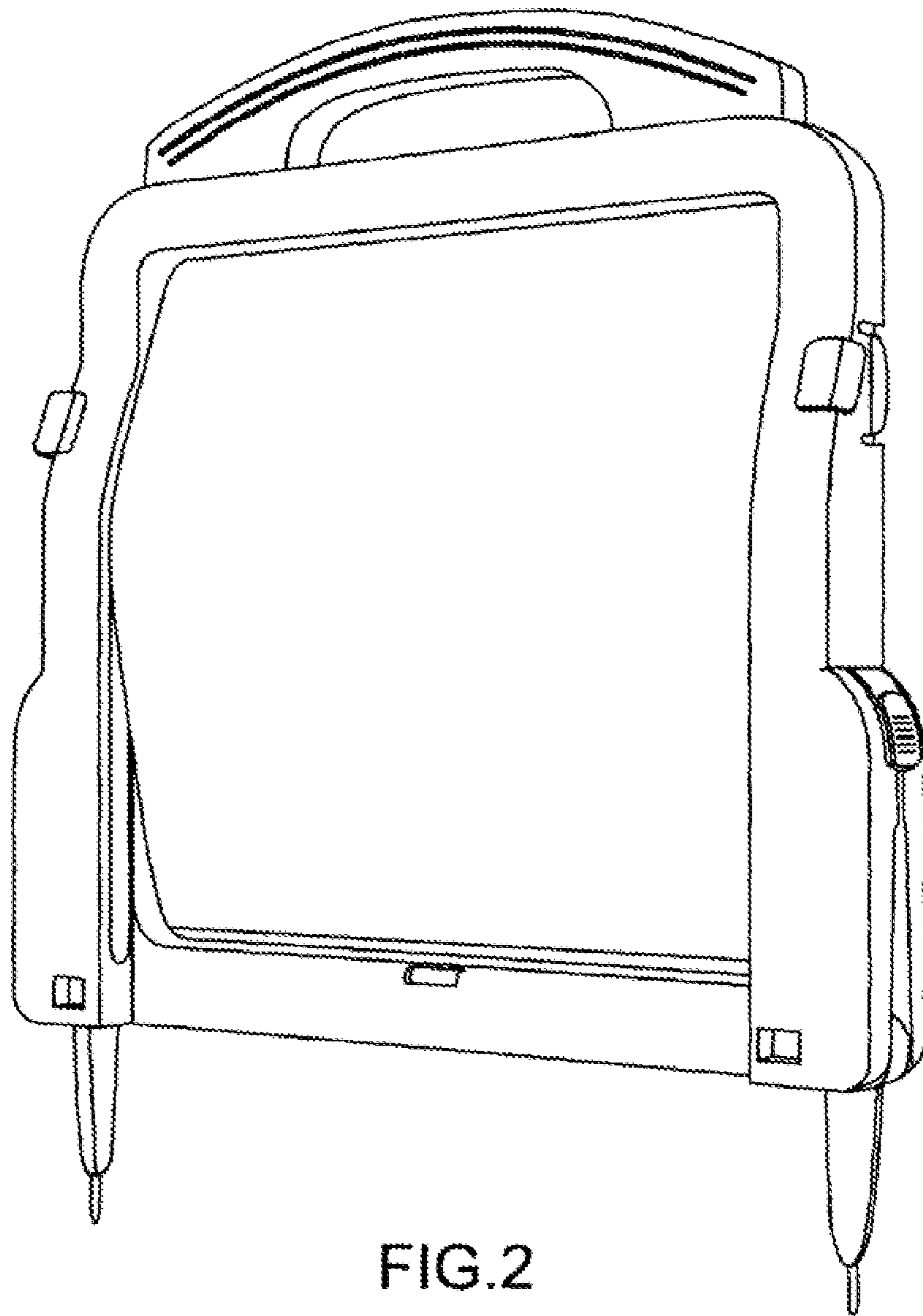

FIG. 2

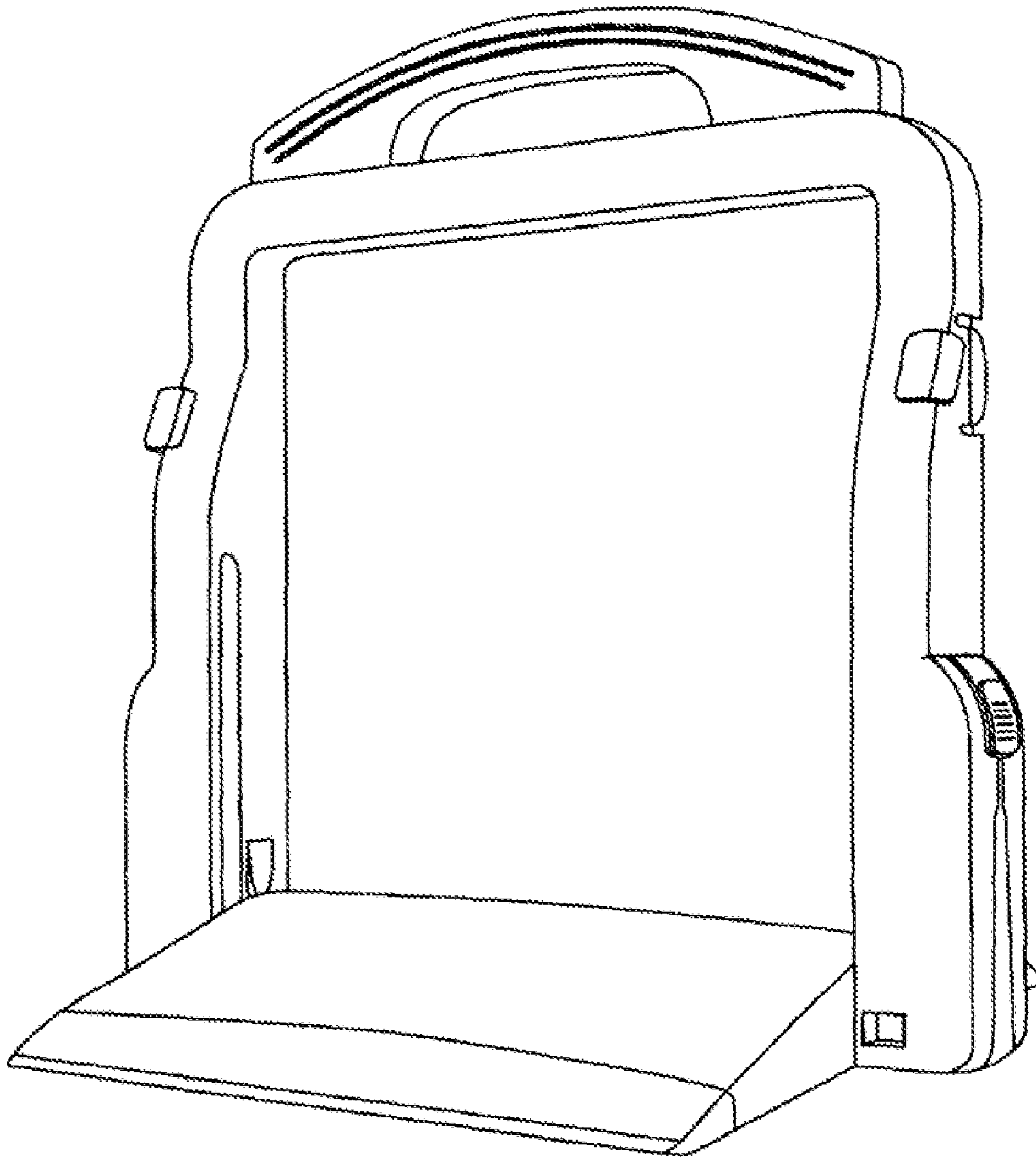

FIG.3

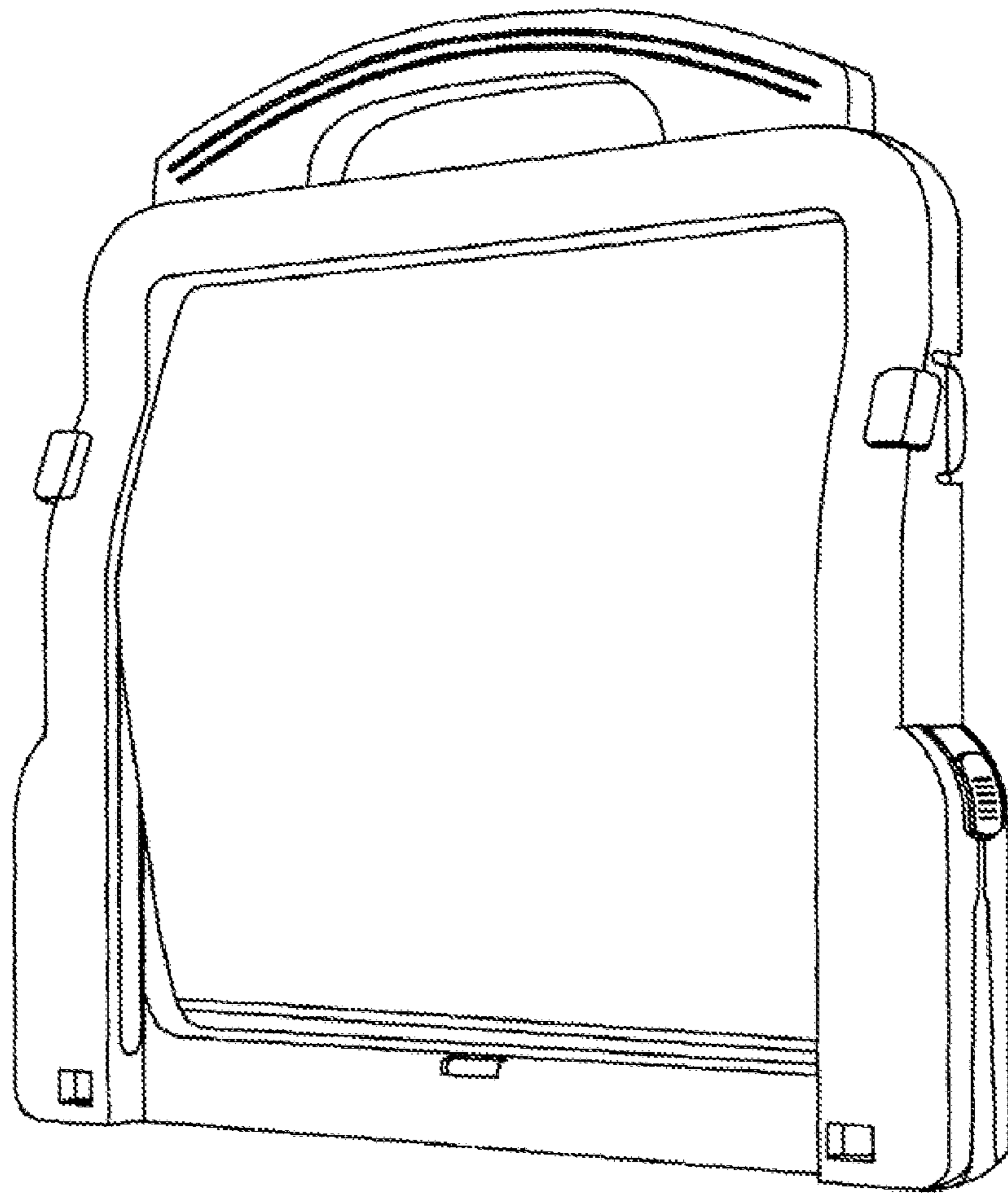

FIG.4

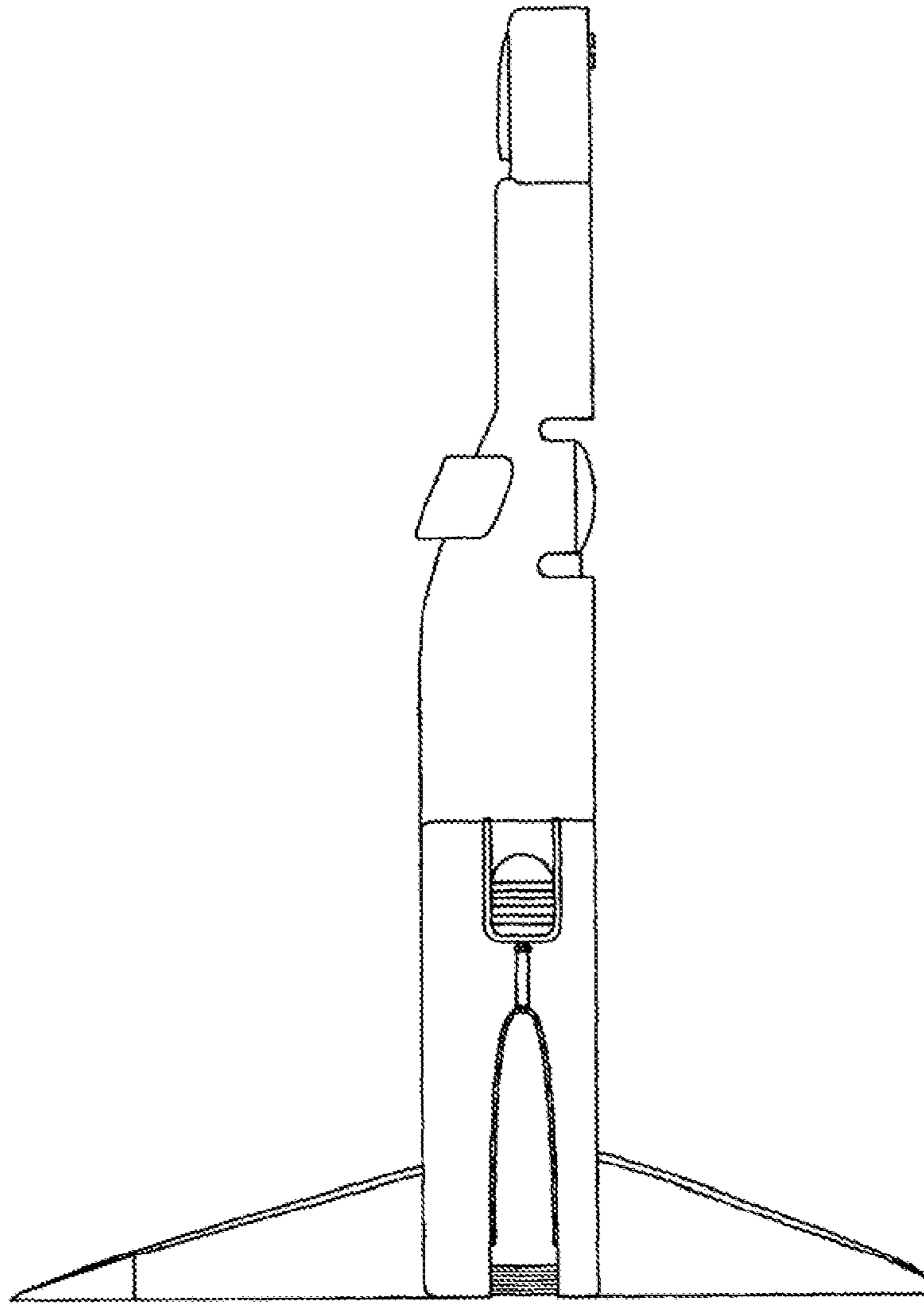

FIG.5

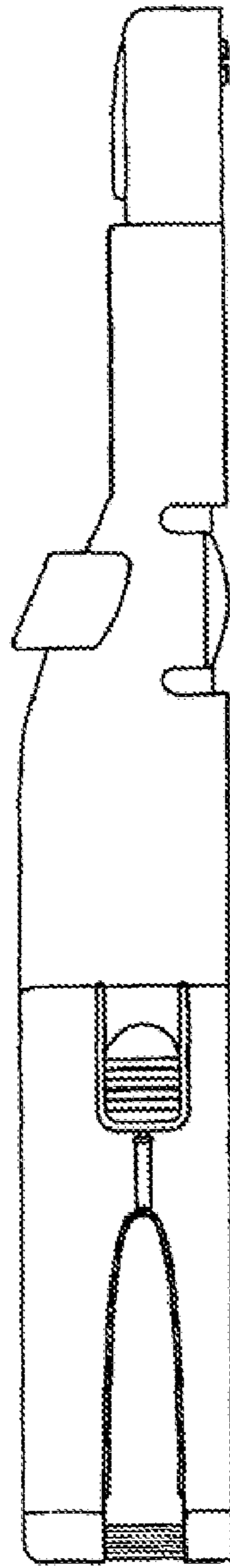

FIG.6

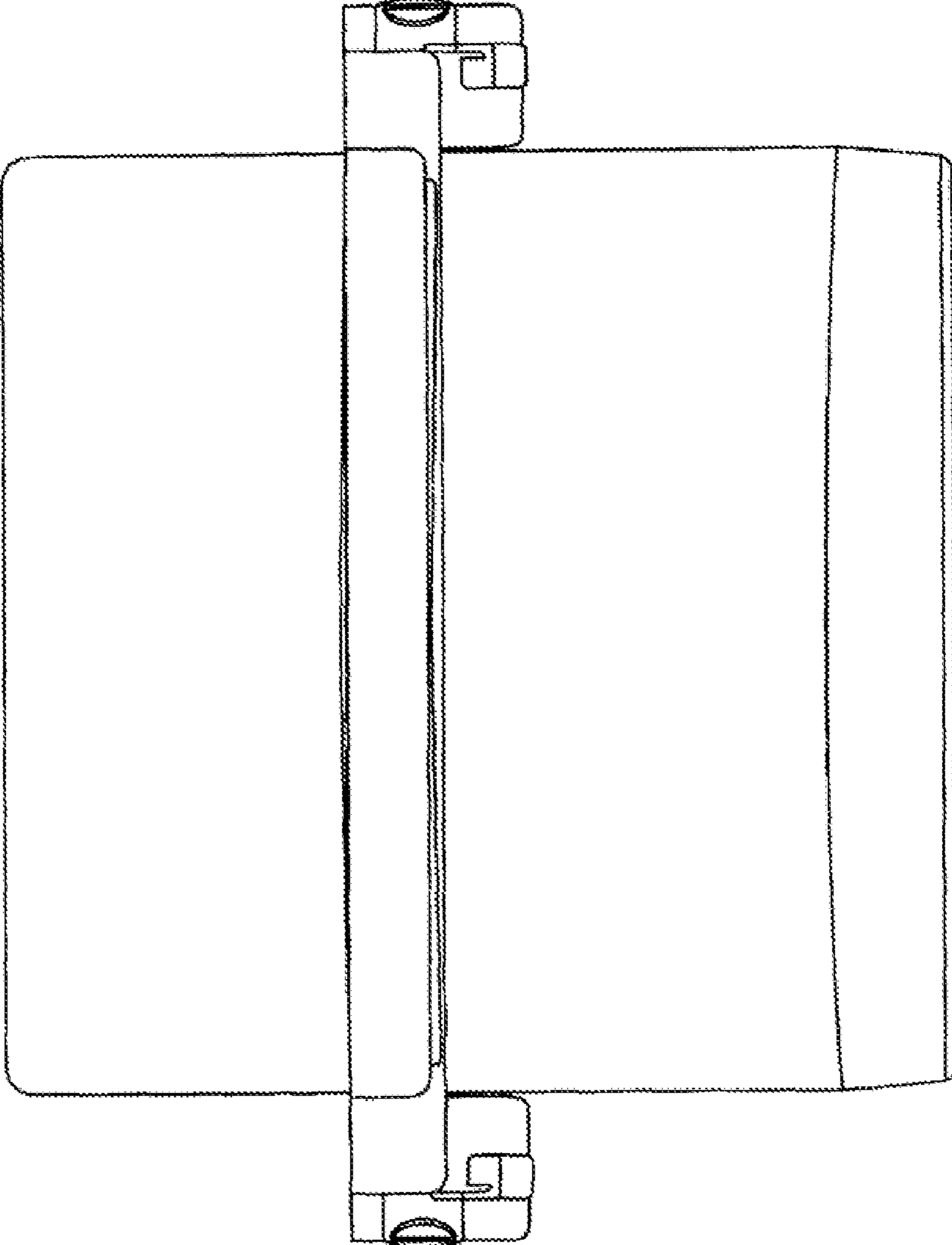

FIG.7

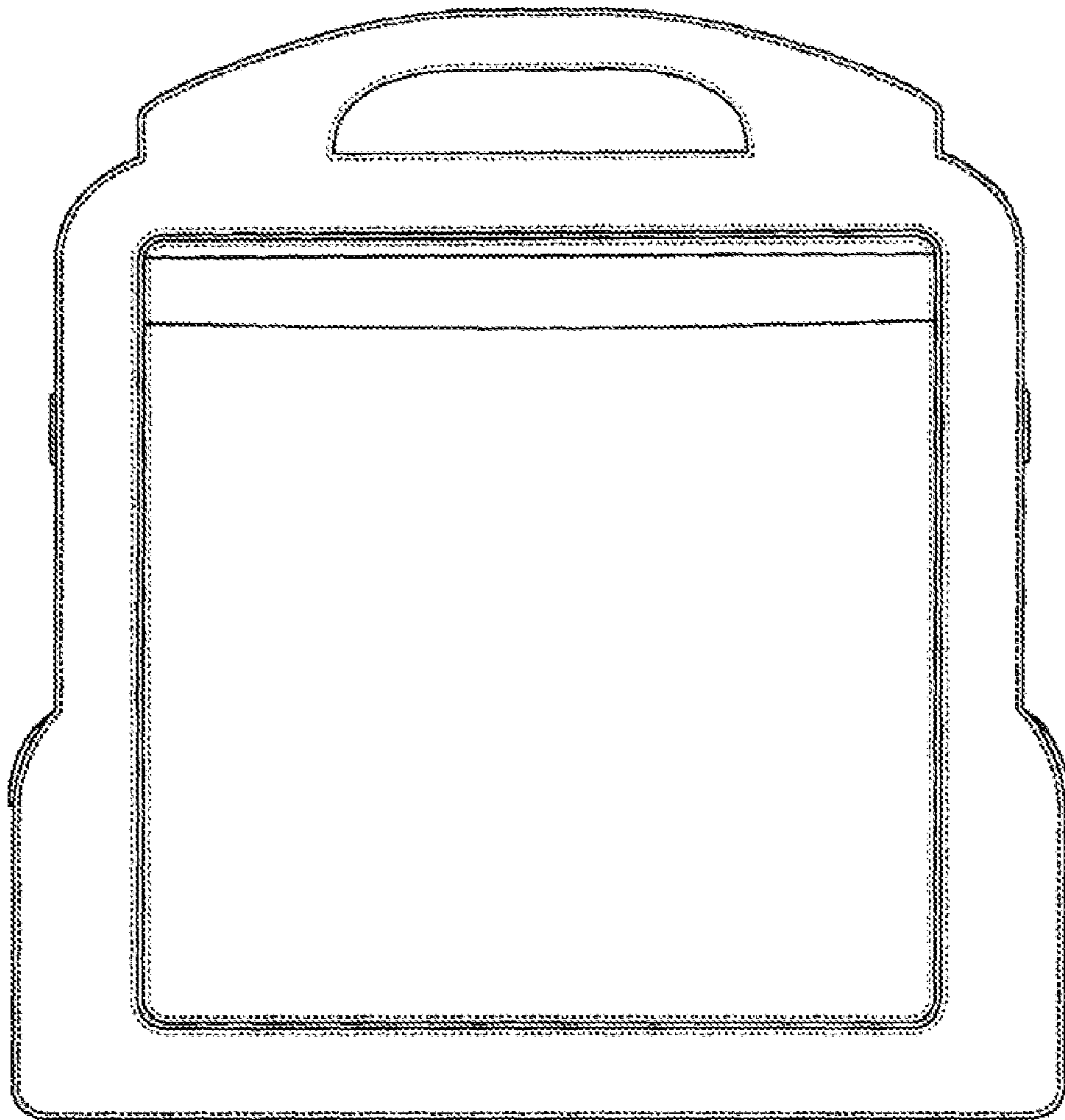

FIG. 8

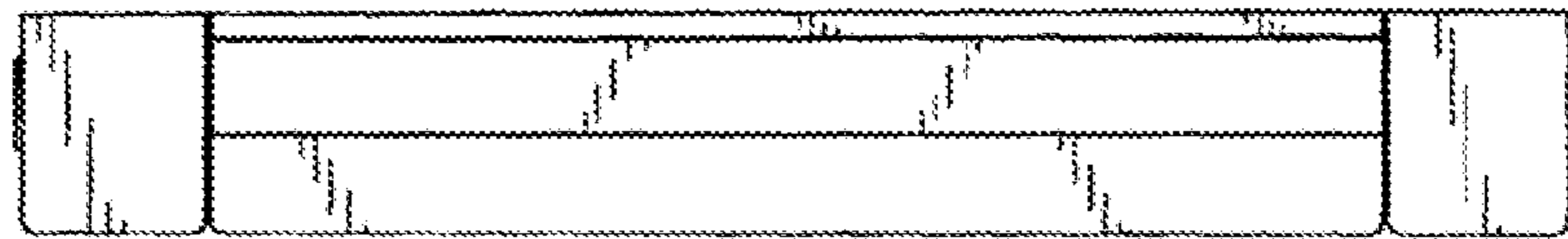

FIG.9

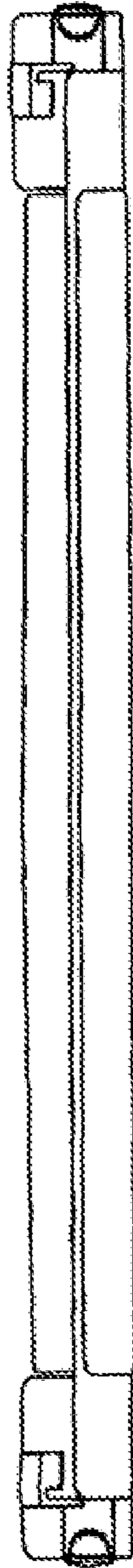

FIG. 10

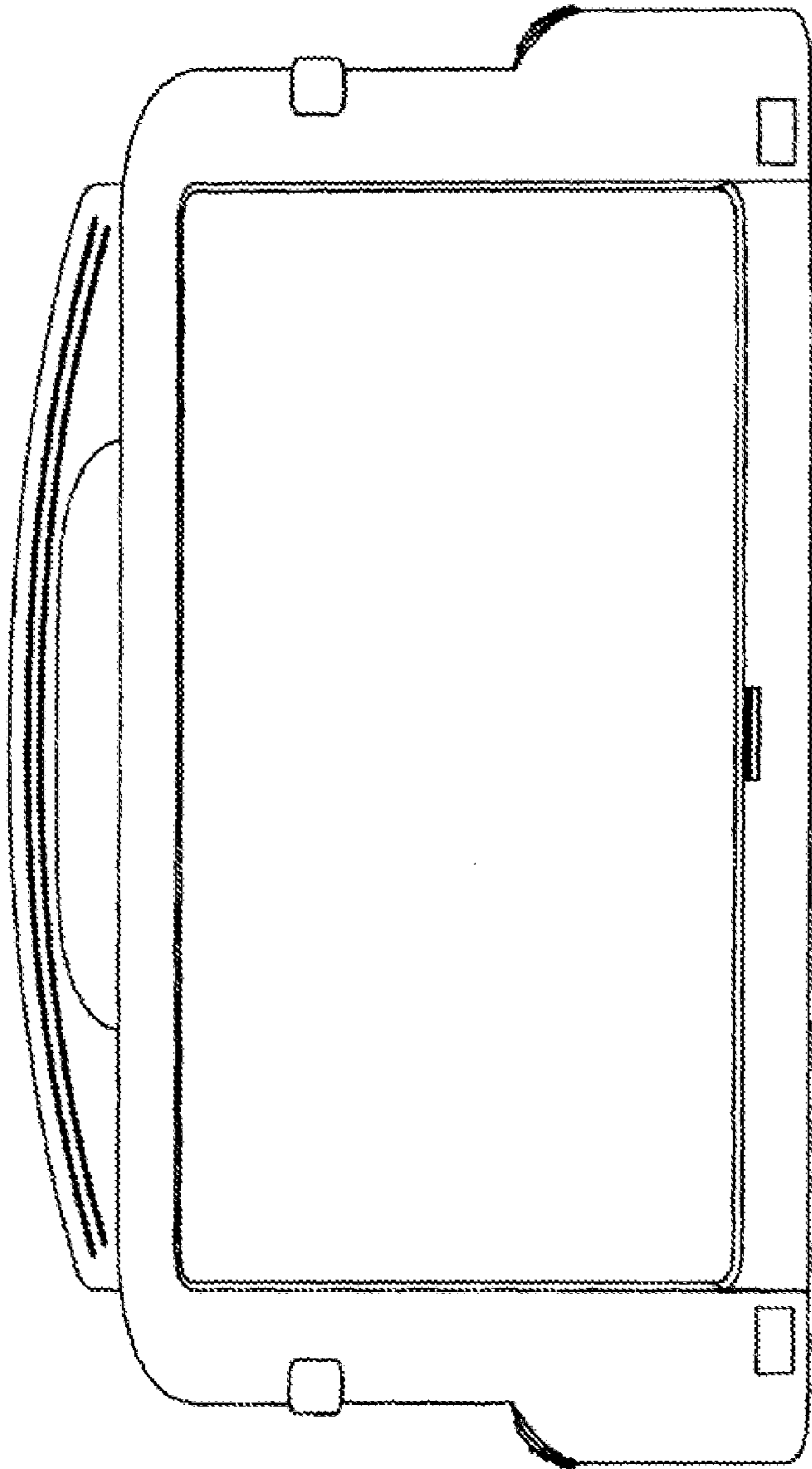

FIG.11

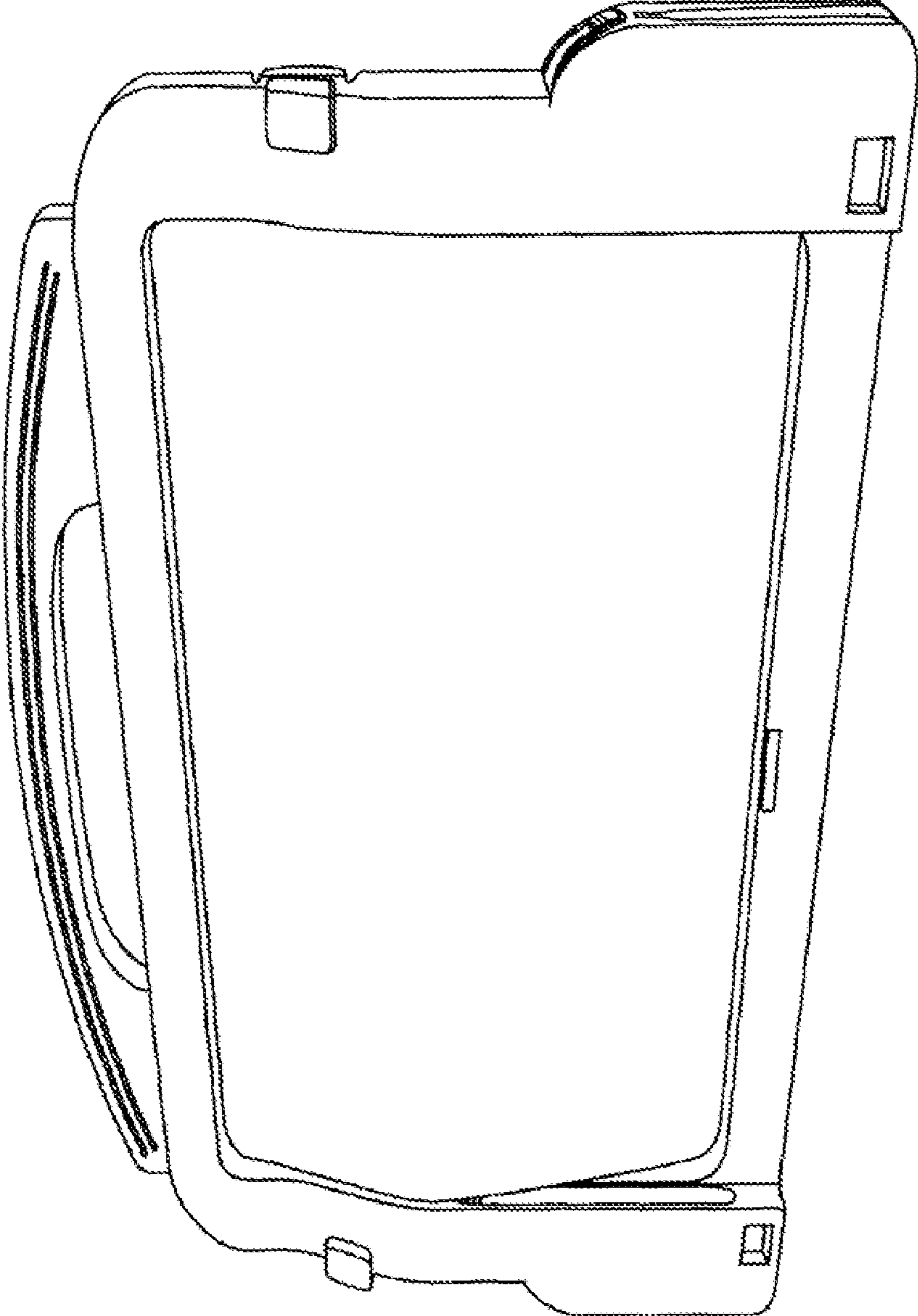

FIG.12

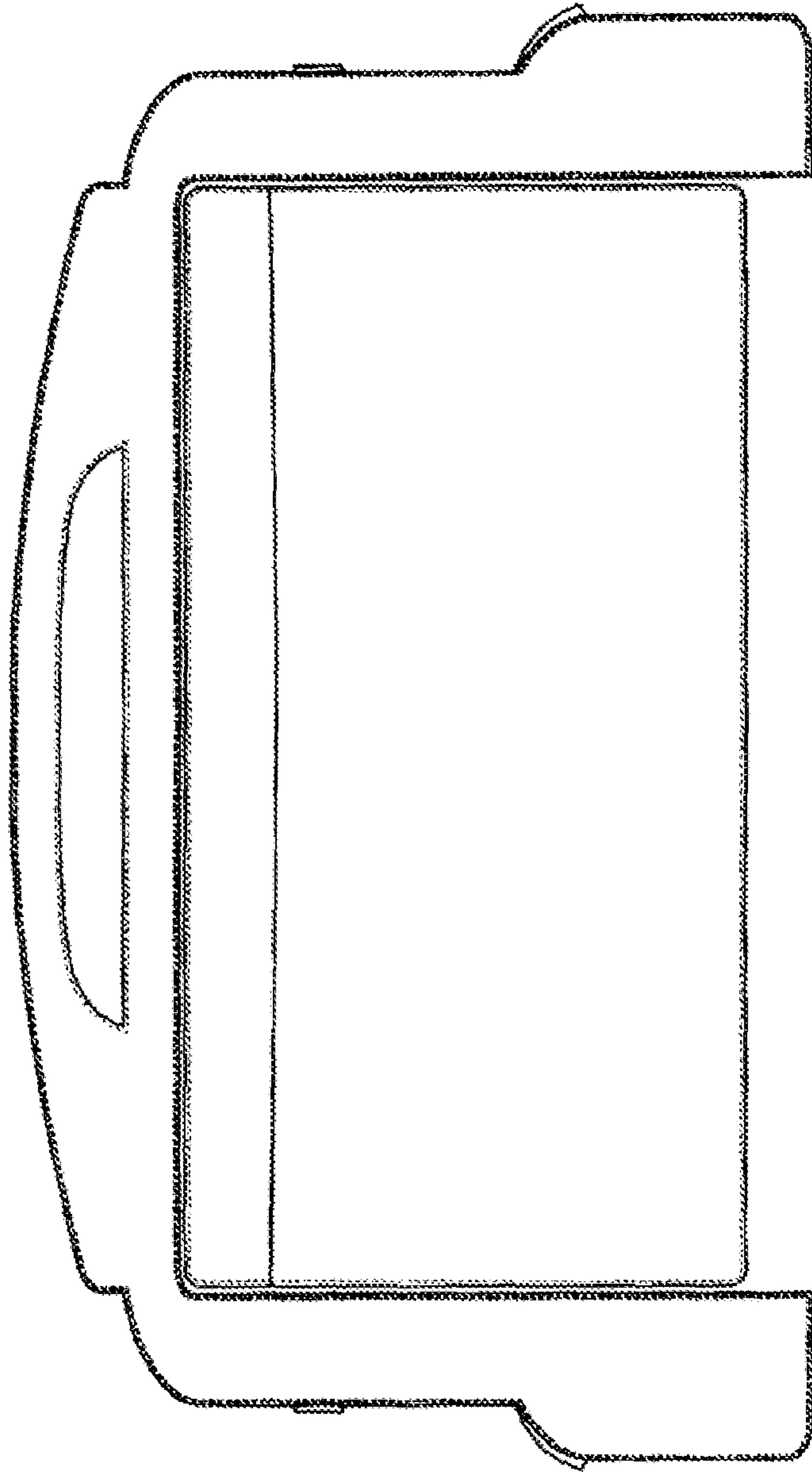

FIG. 13



FIG. 14

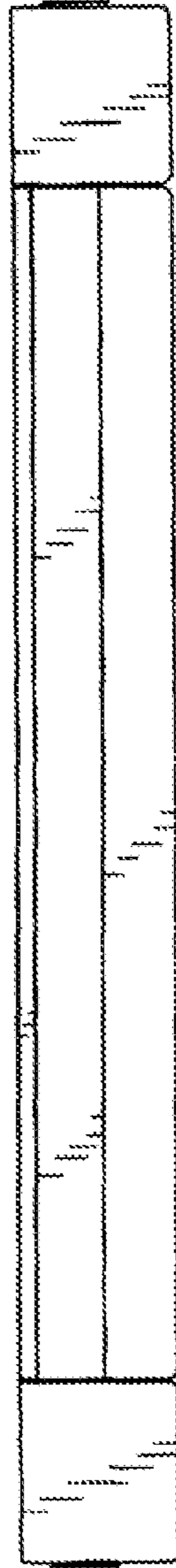

FIG.15

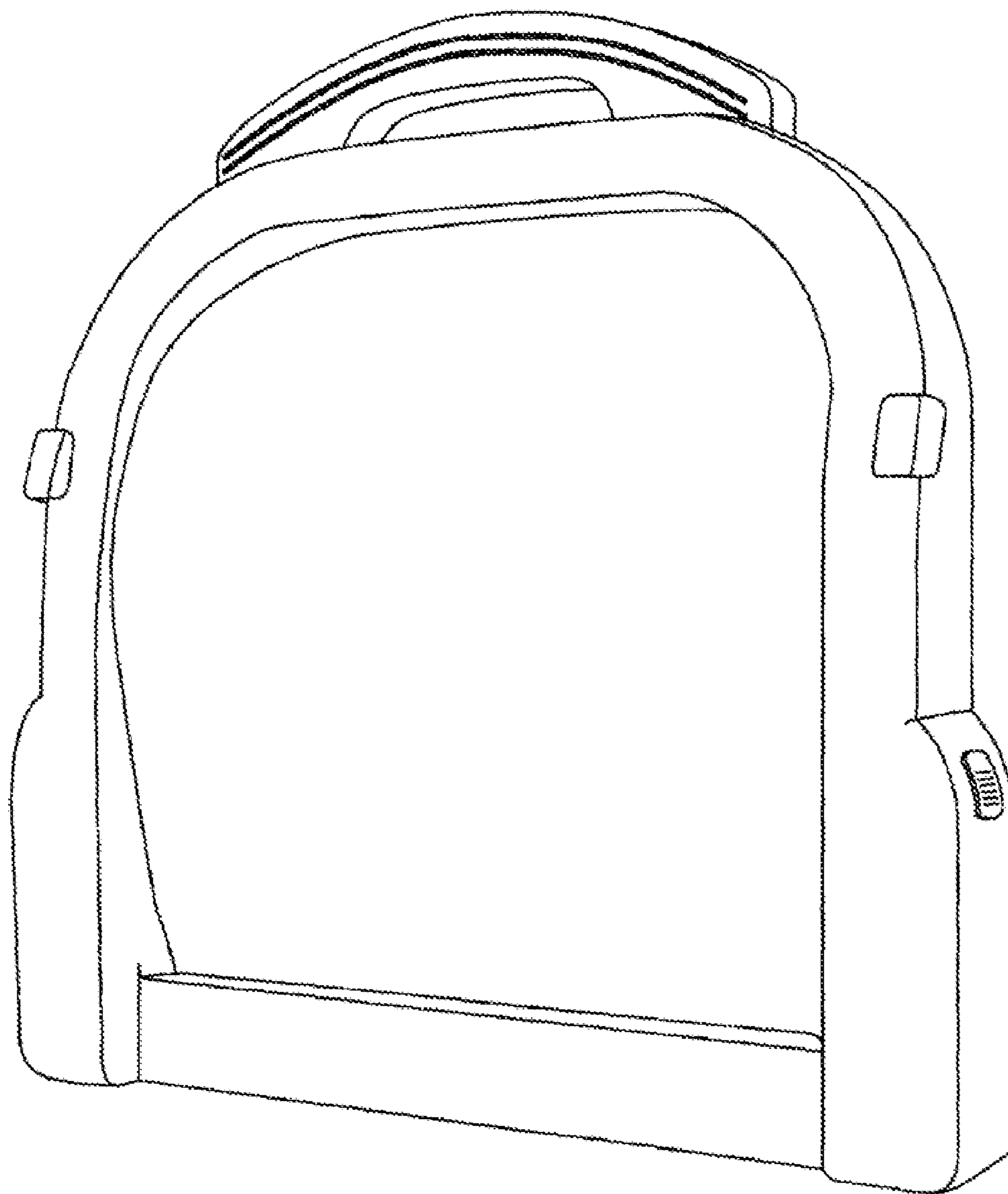

FIG.16

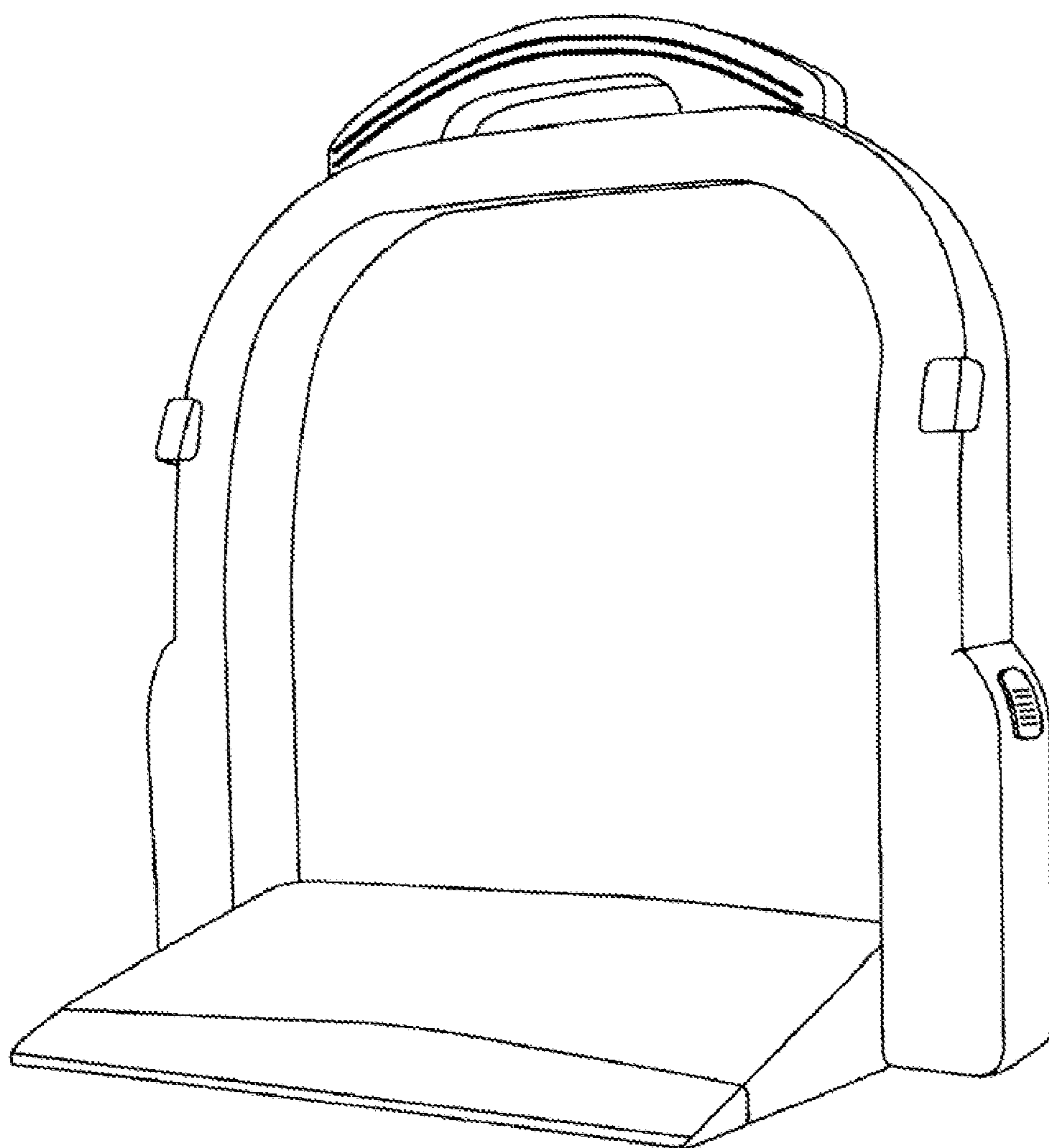

FIG.17

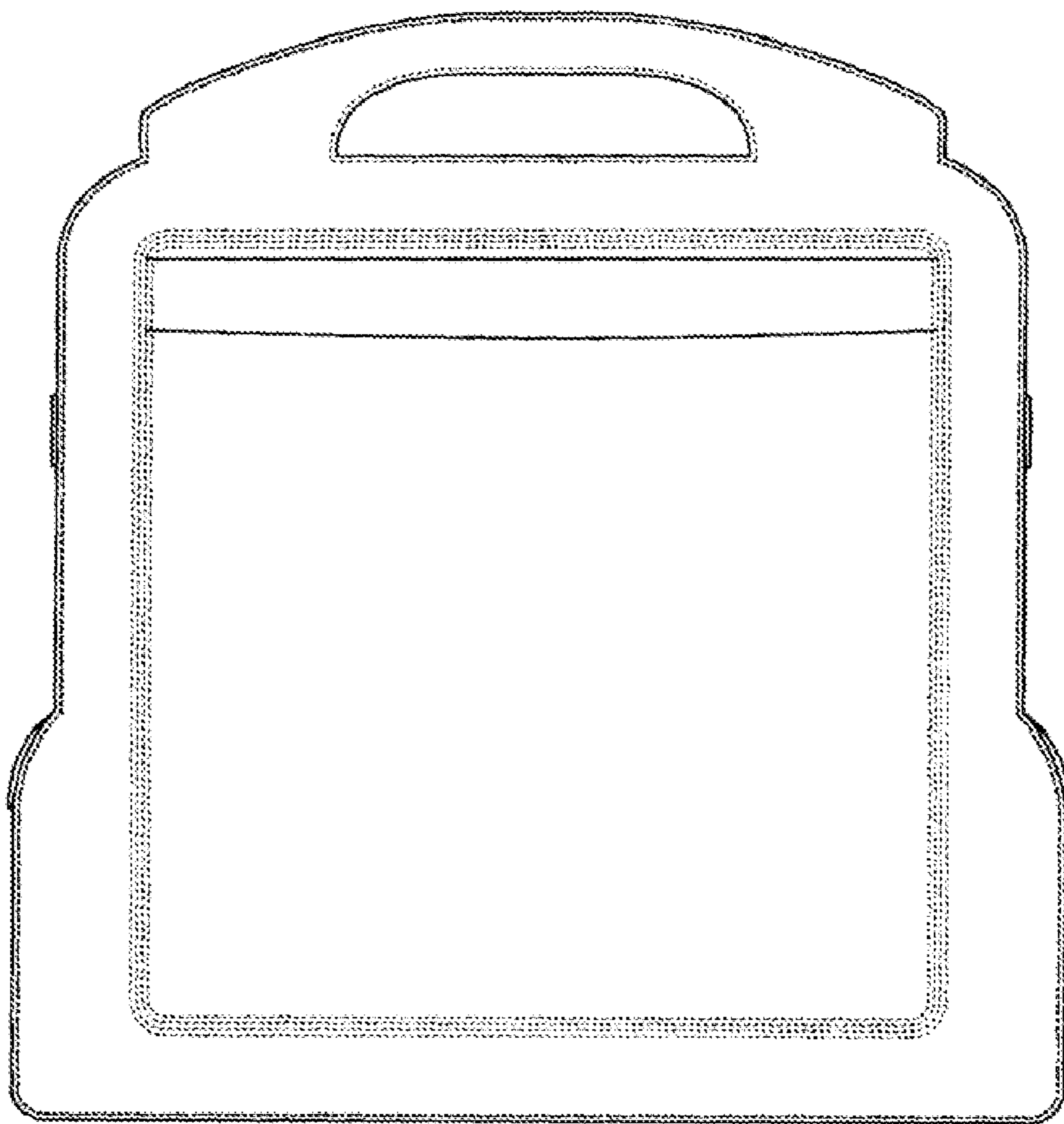

FIG.18



FIG. 19