



US00D627067S

(12) **United States Design Patent**
Daniel

(10) **Patent No.:** **US D627,067 S**
(45) **Date of Patent:** **** Nov. 9, 2010**

(54) **DUST FILTER GUARD WITH A REMOVABLE FILTER**

(75) Inventor: **Isaac Sayo Daniel**, Miami, FL (US)

(73) Assignee: **Lead Technology Capital Management, LLC**, Miami, FL (US)

(**) Term: **14 Years**

(21) Appl. No.: **29/353,293**

(22) Filed: **Jan. 6, 2010**

(51) **LOC (9) Cl.** **24-01**

(52) **U.S. Cl.** **D24/162**

(58) **Field of Classification Search** D24/162,
D24/164, 110.1, 106; D23/209; 55/DIG. 35;
128/201.18, 206.11, 206.18, 207.18

See application file for complete search history.

(56) **References Cited**

U.S. PATENT DOCUMENTS

3,905,335	A *	9/1975	Kapp	128/206.11
D251,017	S *	2/1979	Amezcu	D24/106
4,267,831	A *	5/1981	Aguilar	128/206.11
4,327,719	A *	5/1982	Childers	128/206.11
D451,193	S *	11/2001	McCormick	D24/106
6,978,781	B1 *	12/2005	Jordan	128/206.11
D556,325	S *	11/2007	Michaels	D24/162
D572,360	S *	7/2008	Dolezal et al.	D24/106
D608,441	S *	1/2010	Scharlott	D24/106
2007/0175478	A1 *	8/2007	Brunst	128/206.18
2008/0023007	A1 *	1/2008	Dolezal et al.	128/206.11

* cited by examiner

Primary Examiner—T. Chase Nelson

Assistant Examiner—Anhdao Doan

(74) *Attorney, Agent, or Firm*—Carol N. Green, Esq.

(57) **CLAIM**

The ornamental design for a dust filter guard with a removable filter, as shown and described.

DESCRIPTION

FIG. 1 is a front perspective view of the invention.

FIG. 2 is a rear perspective view of the invention.

FIG. 3 is a front plan view of the invention.

FIG. 4 is a rear plan view of the invention.

FIG. 5 is a side view of the invention.

FIG. 6 is a top plan view of the invention.

FIG. 7 is a front perspective view of the invention with the removable filter detached.

FIG. 8 is a rear perspective view of the invention with the removable filter detached.

FIG. 9 is a front plan view of the invention with the removable filter detached.

FIG. 10 is a front plan view of the invention with the removable filter detached.

FIG. 11 is a side view of the invention with the removable filters detached and placed side by side with the main component.

FIG. 12 is a top plan view of the invention with the removable filter detached; and,

FIG. 13 is a front view of the invention being worn as a dust filter guard. The phantom lines shown in FIG. 13 are for illustrative purposes only and form no part of the claimed design.

1 Claim, 8 Drawing Sheets

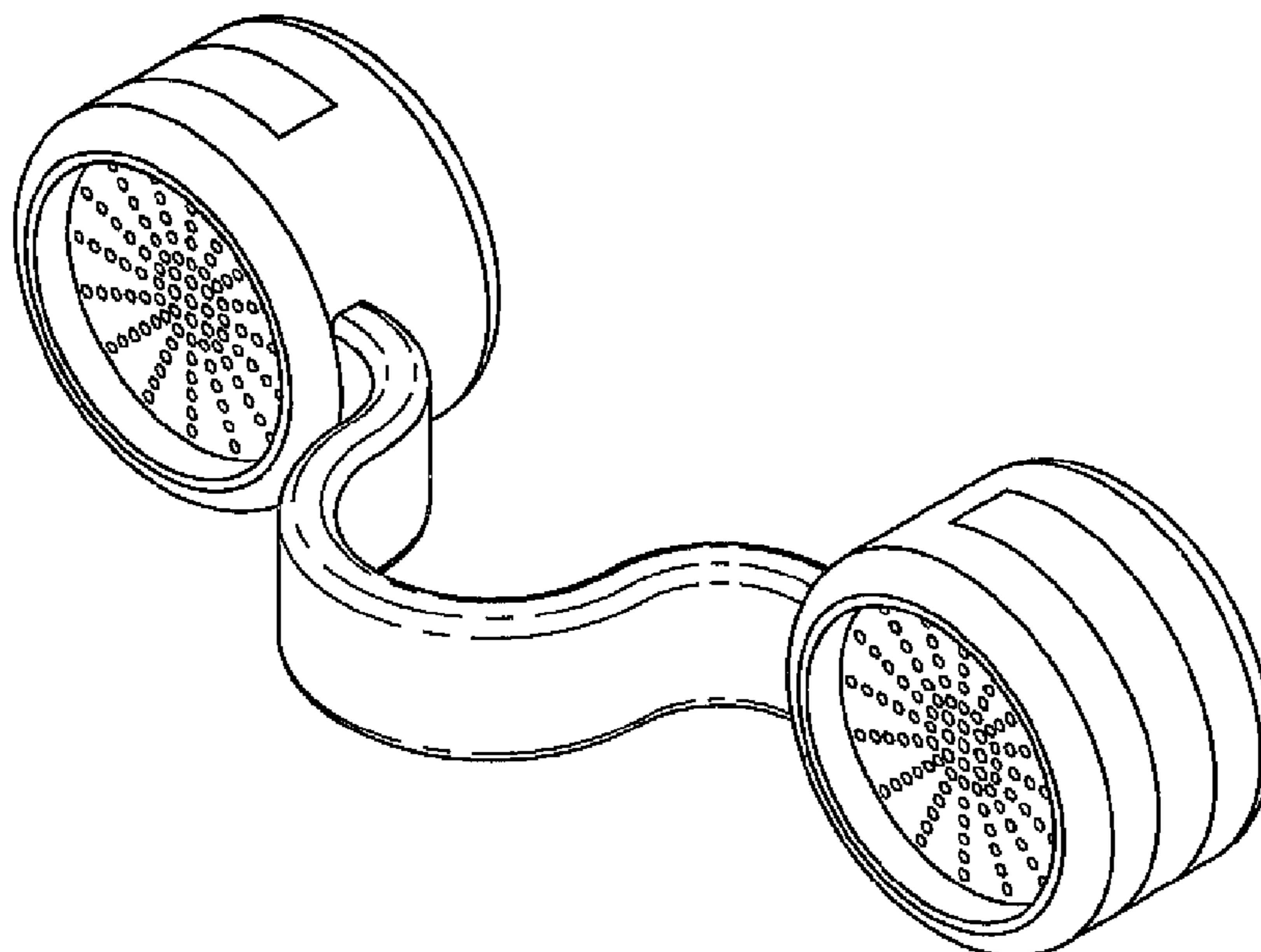

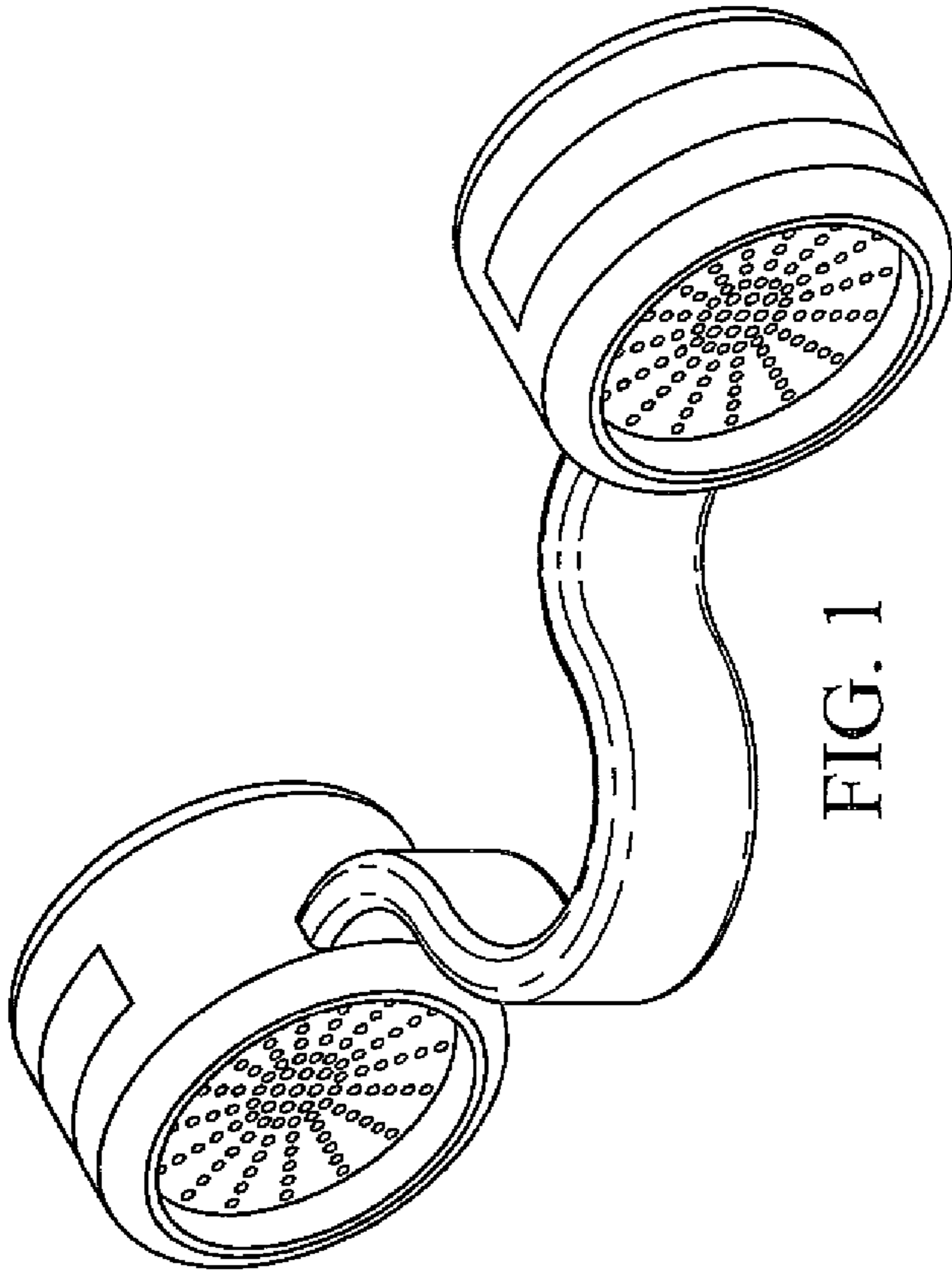

FIG. 1

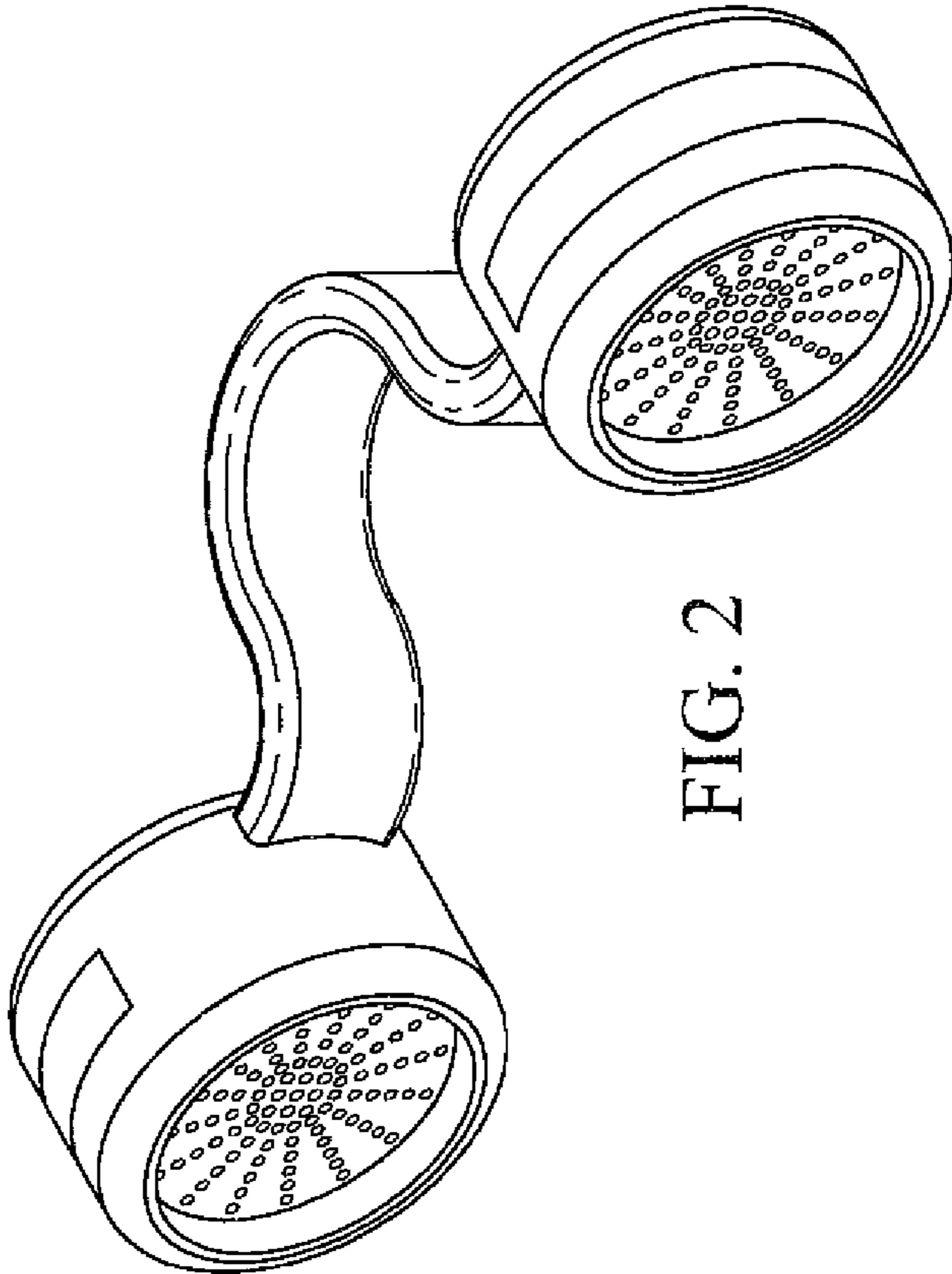

FIG. 2

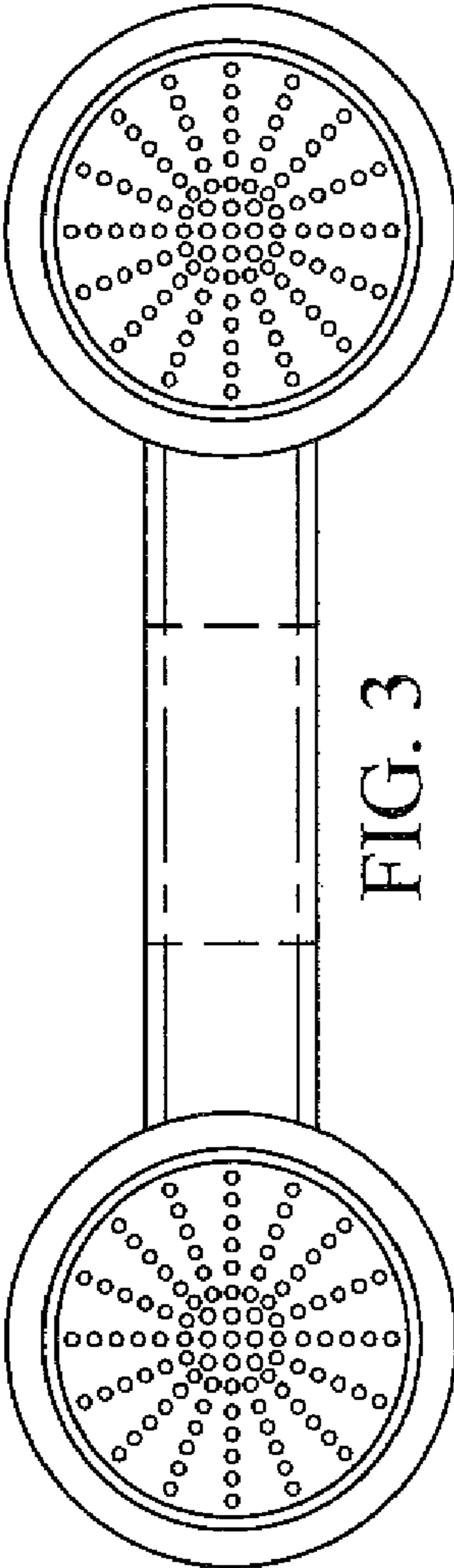

FIG. 3

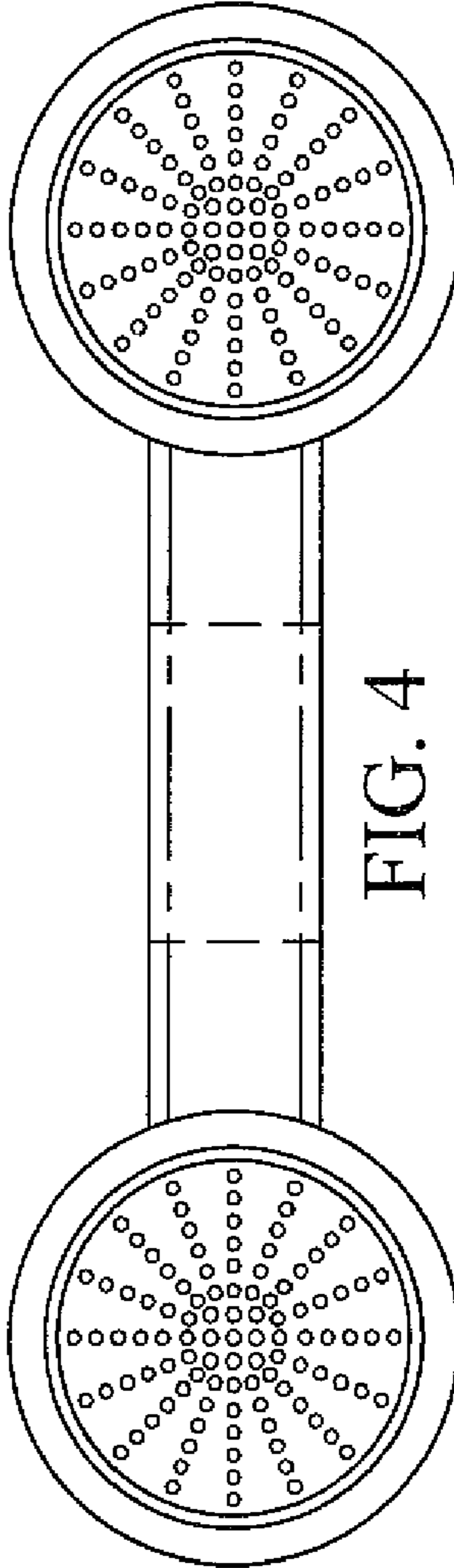

FIG. 4

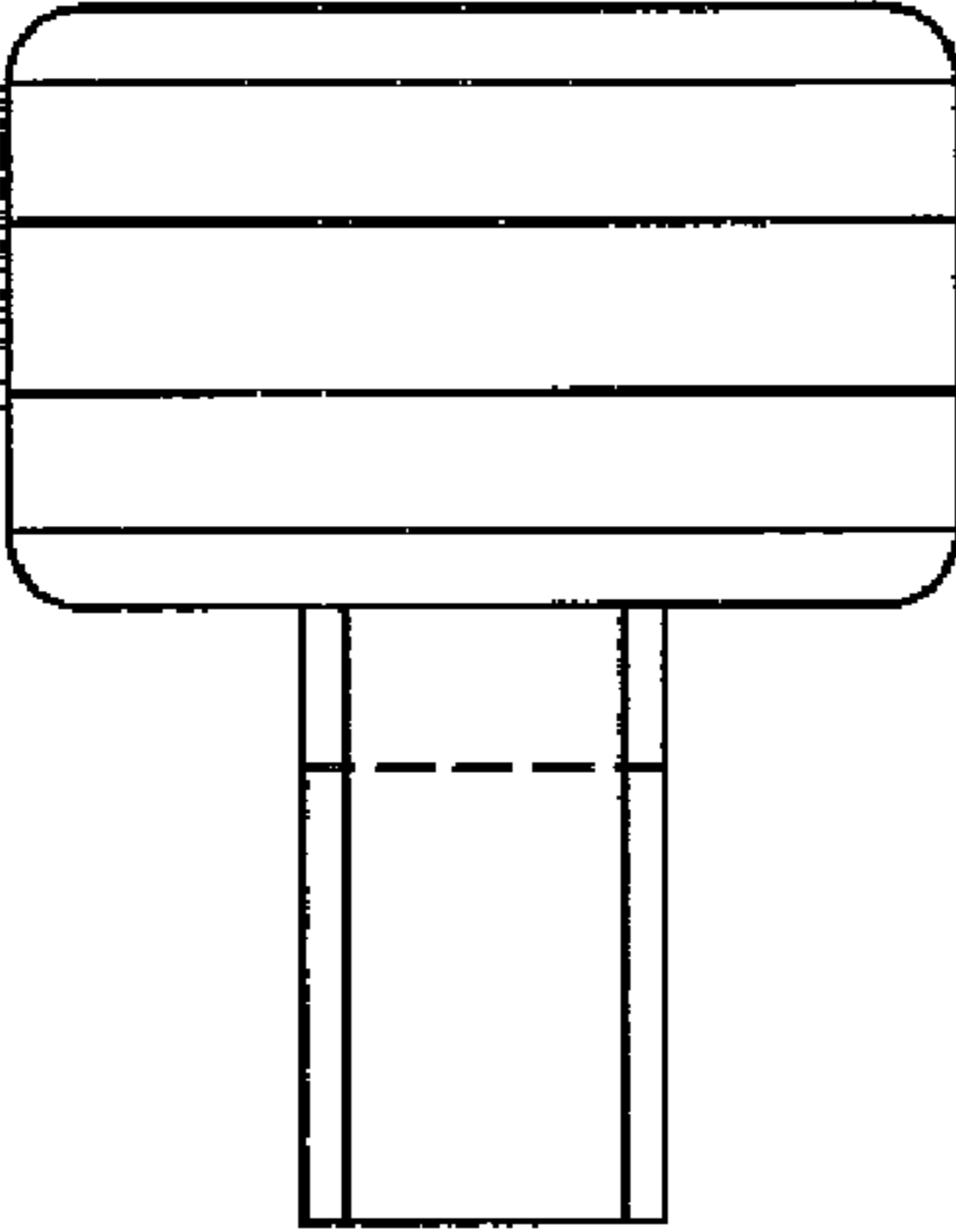

FIG. 5

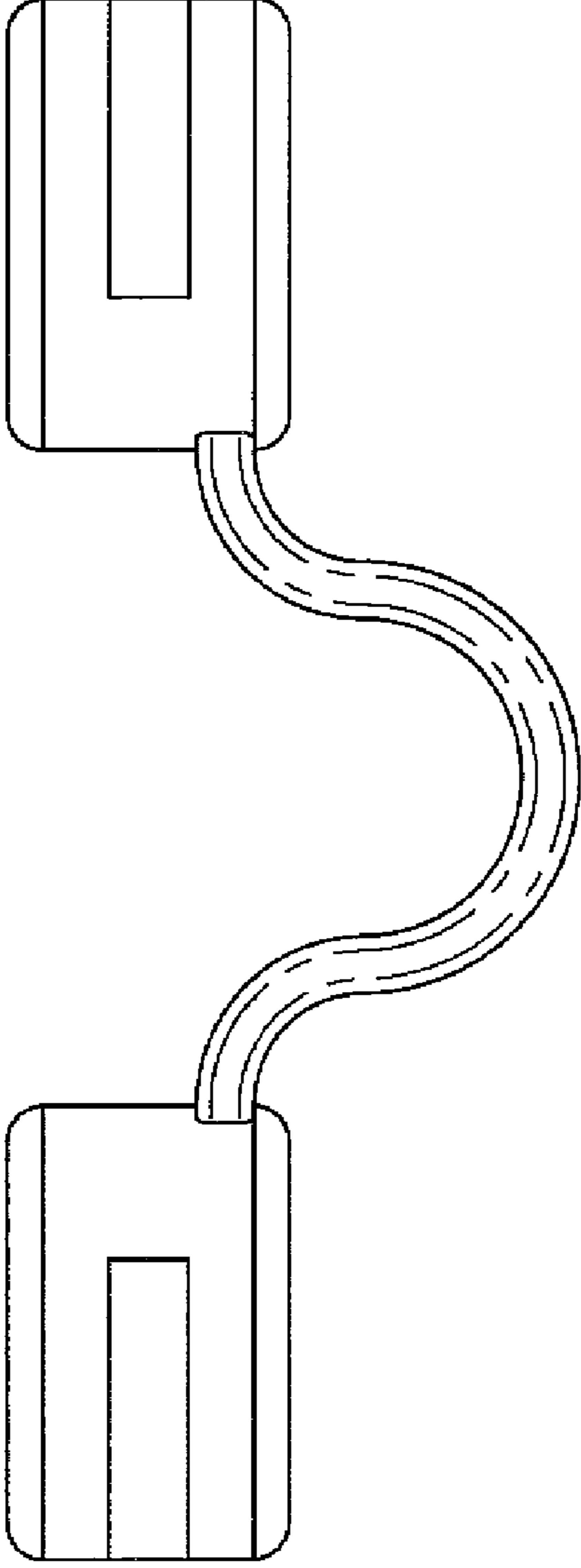

FIG. 6

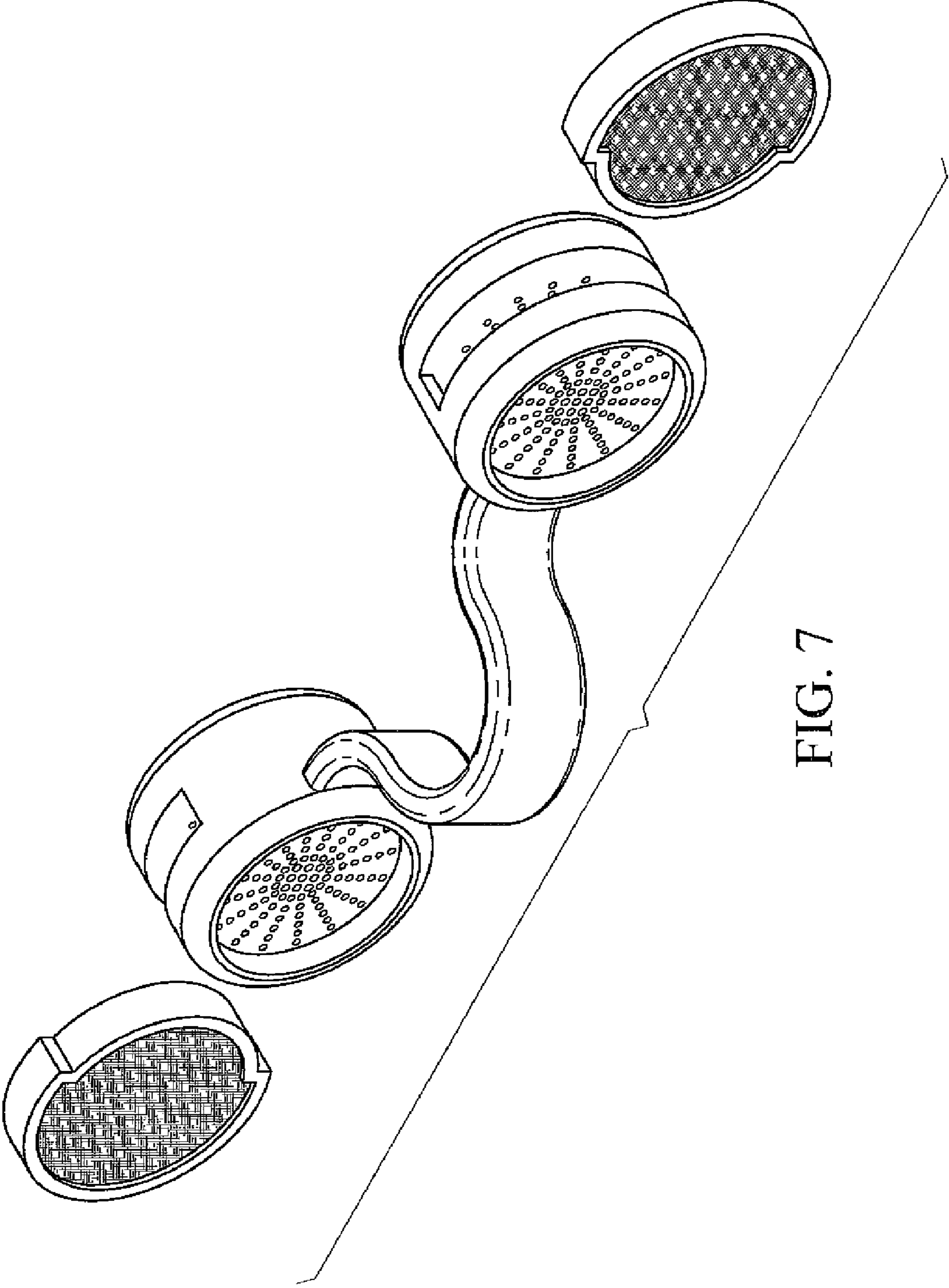

FIG. 7

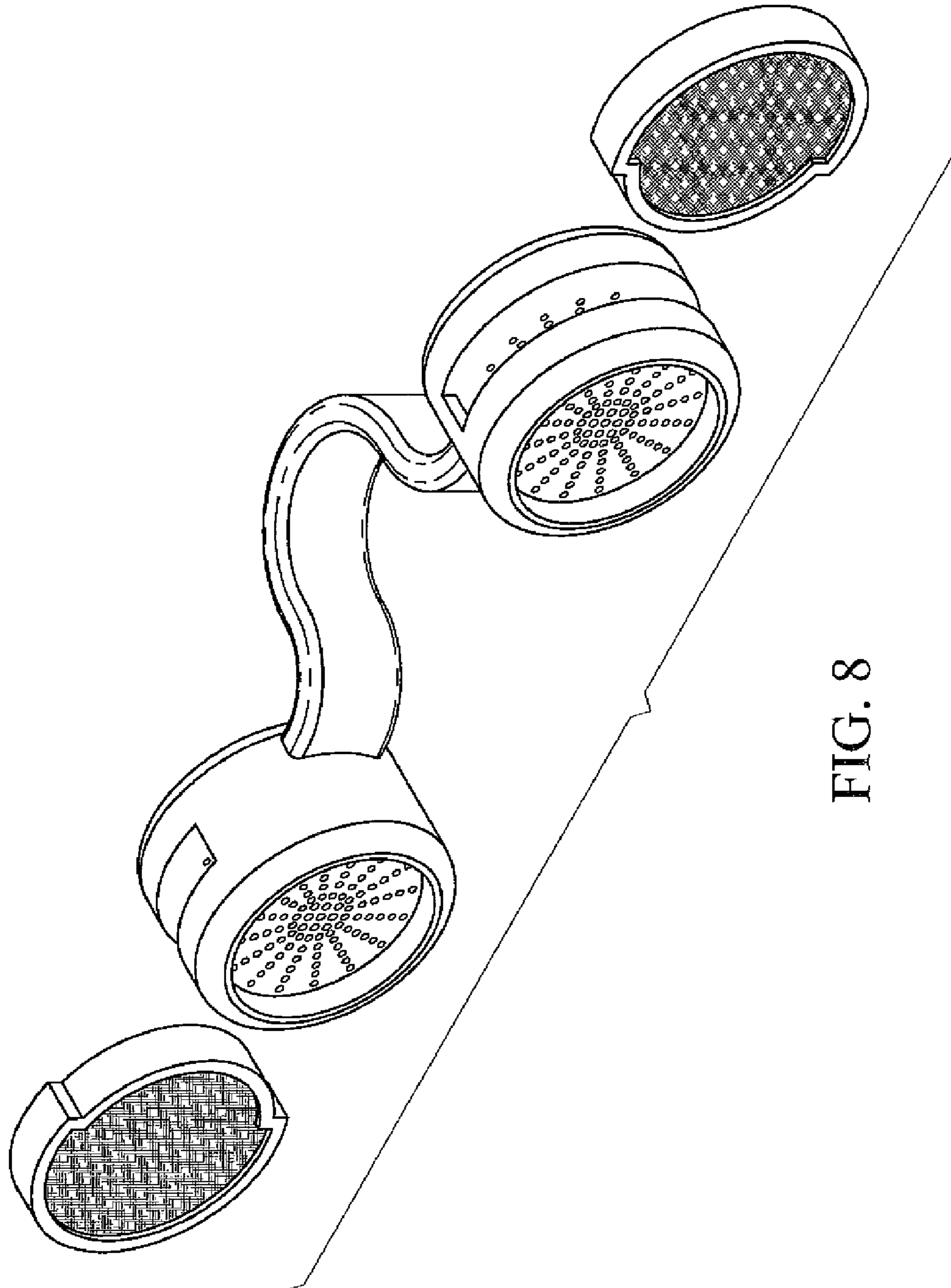

FIG. 8

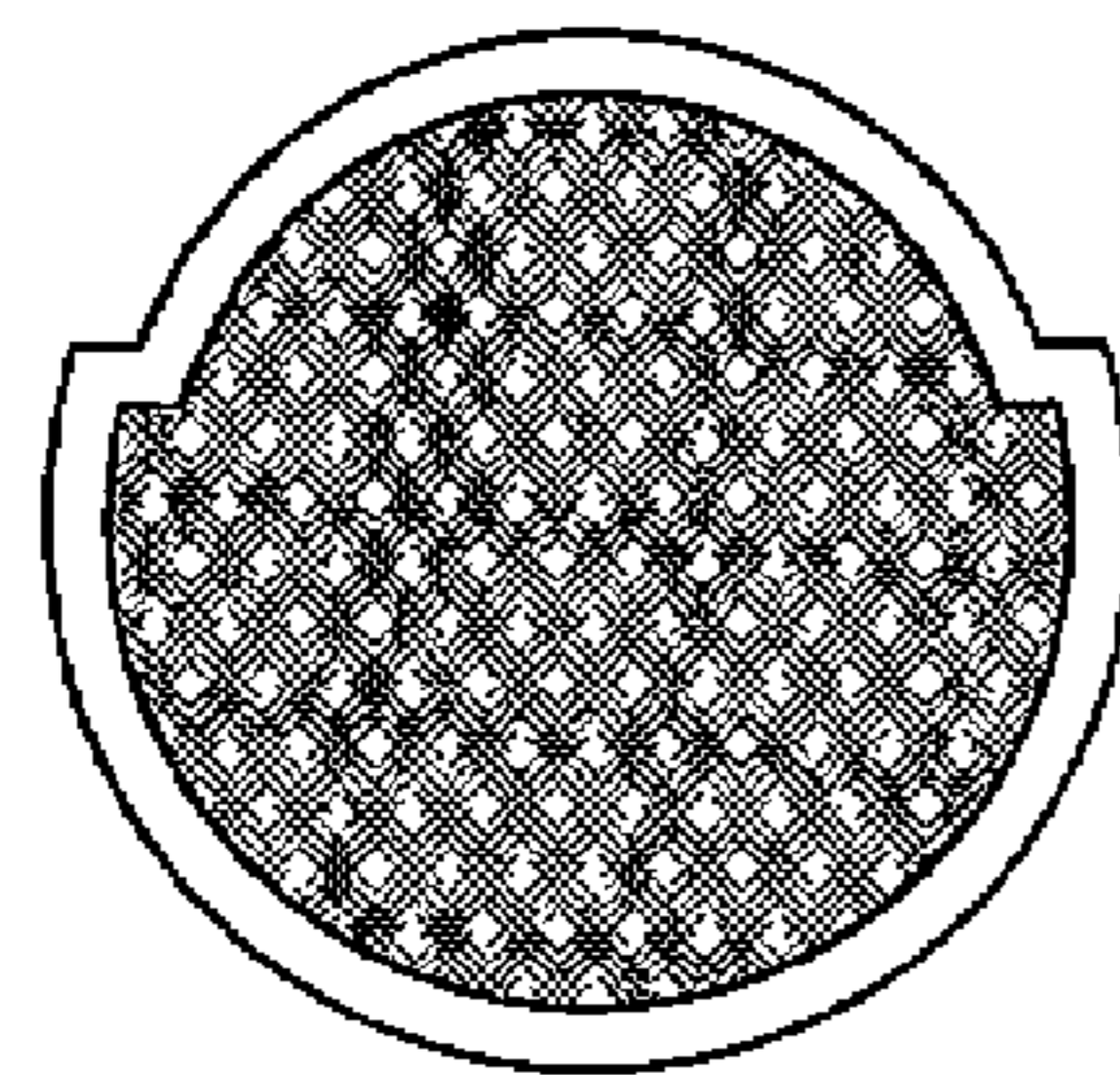
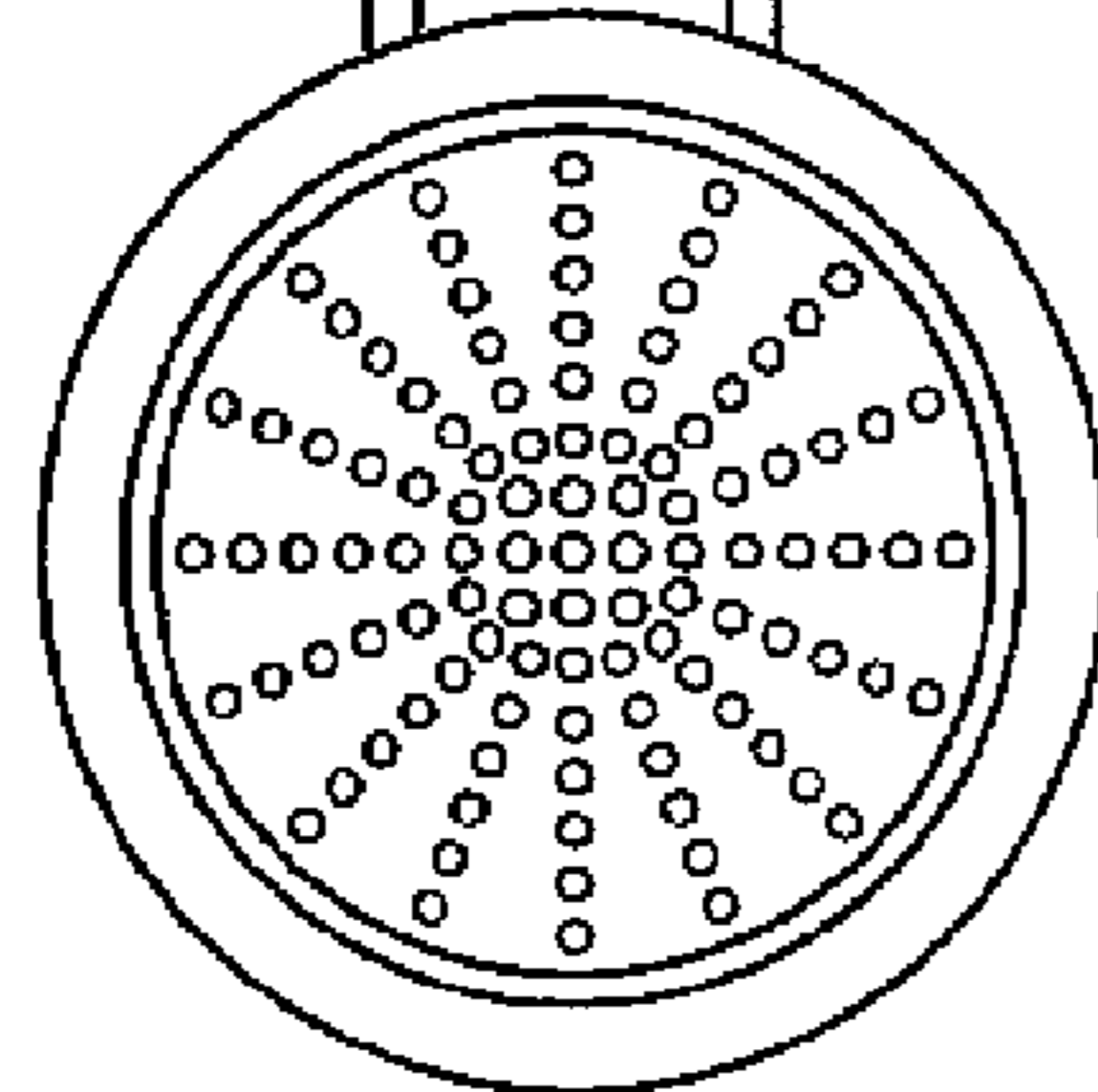
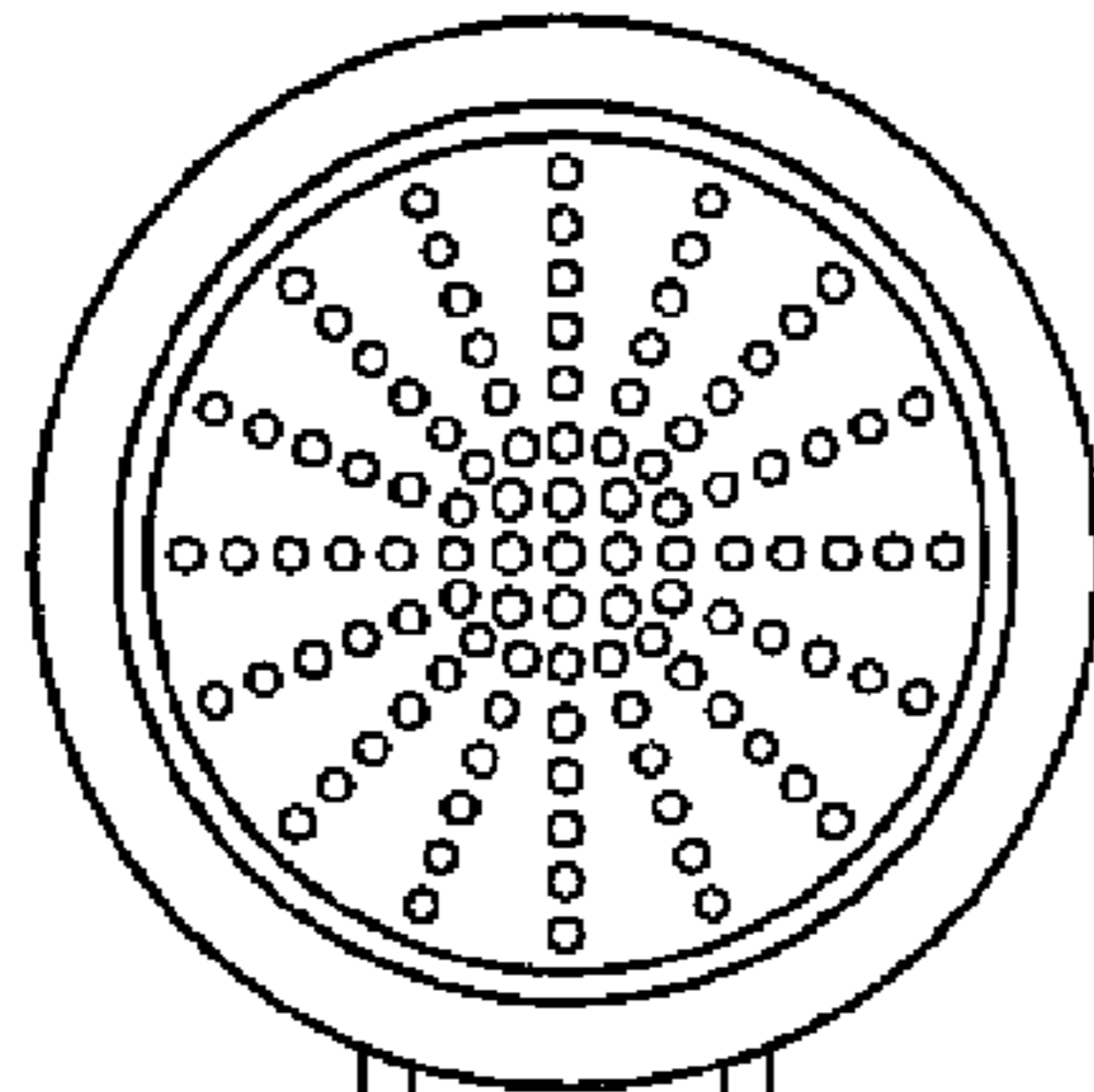
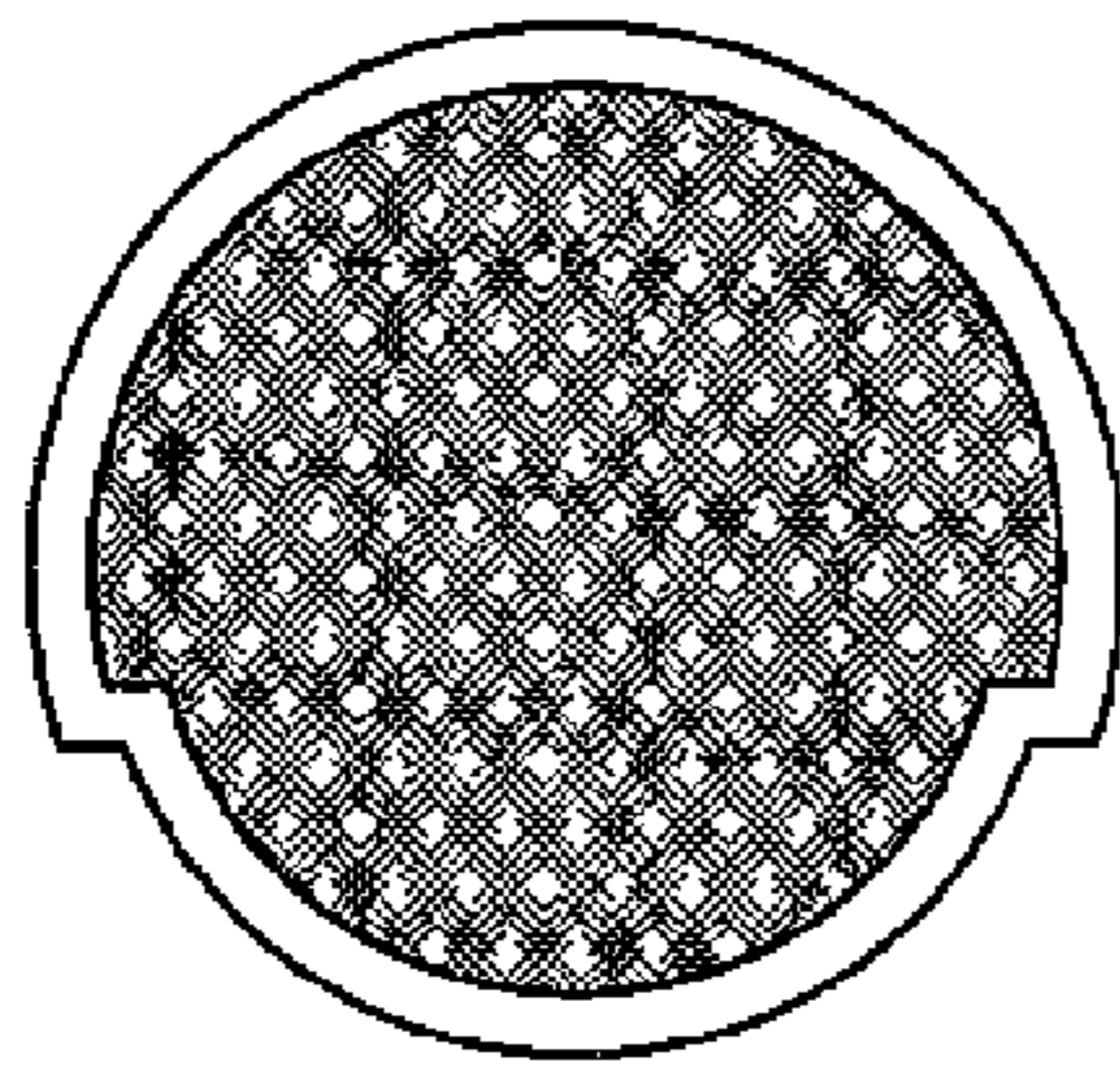

FIG. 9

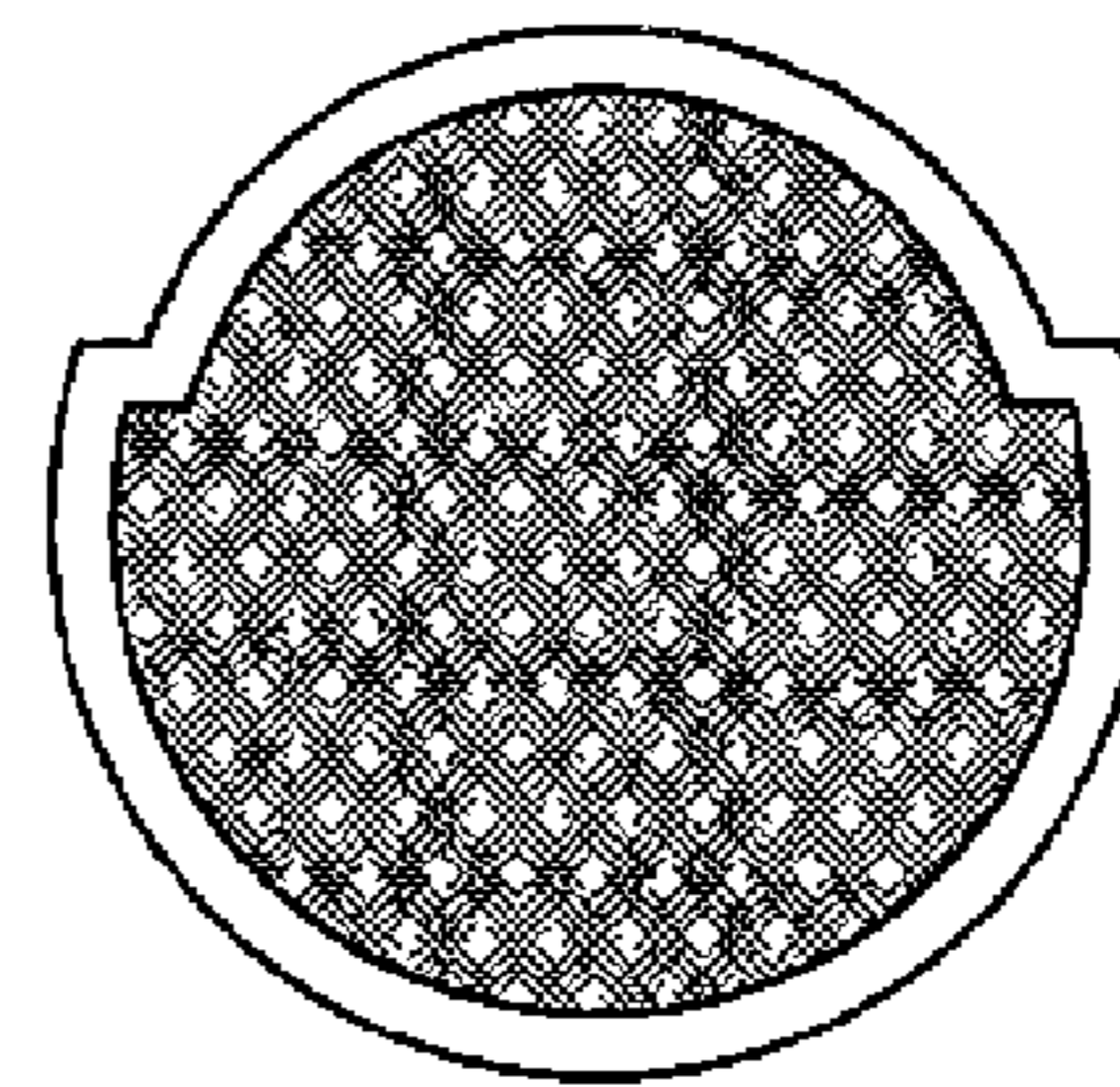
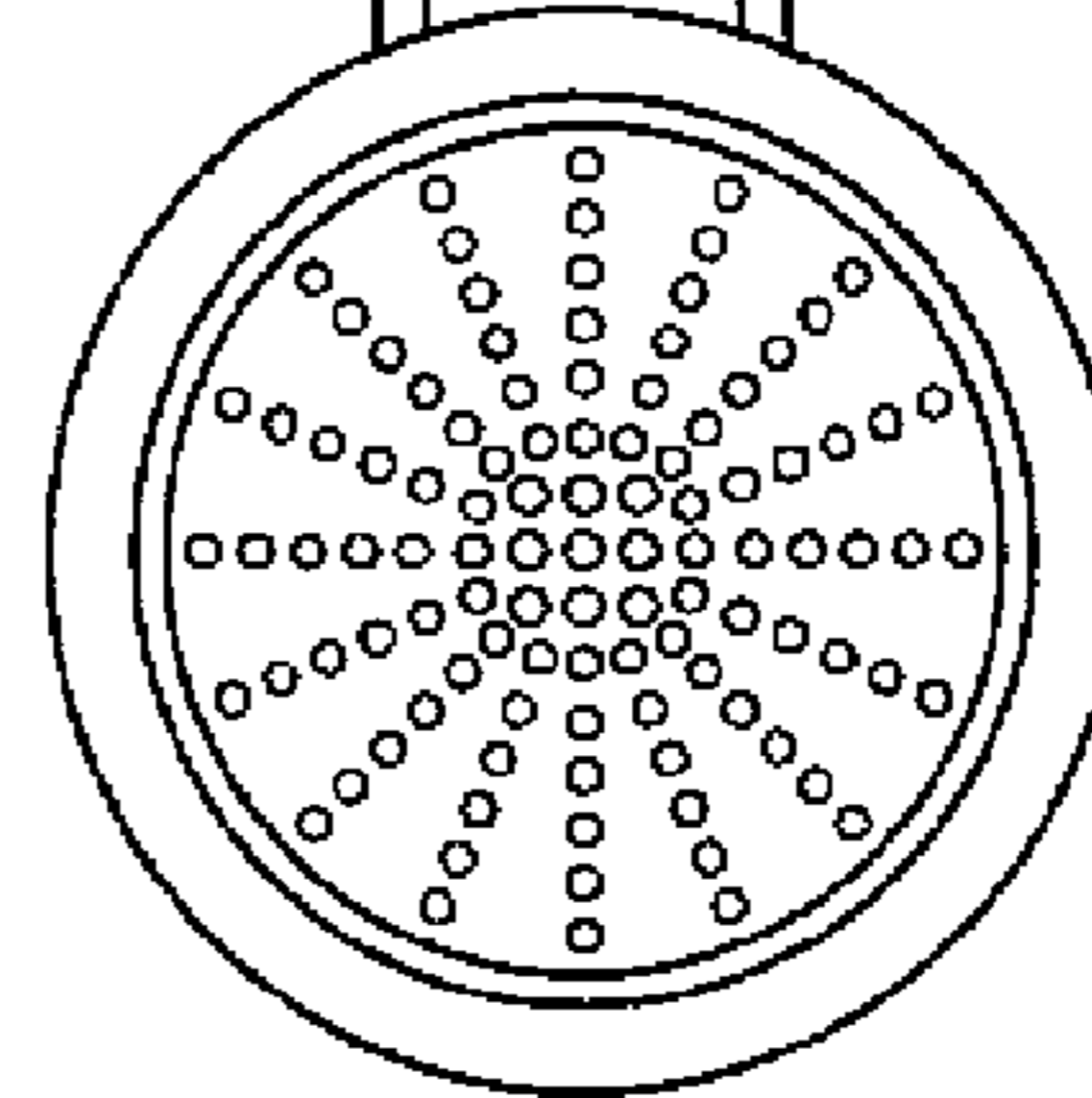
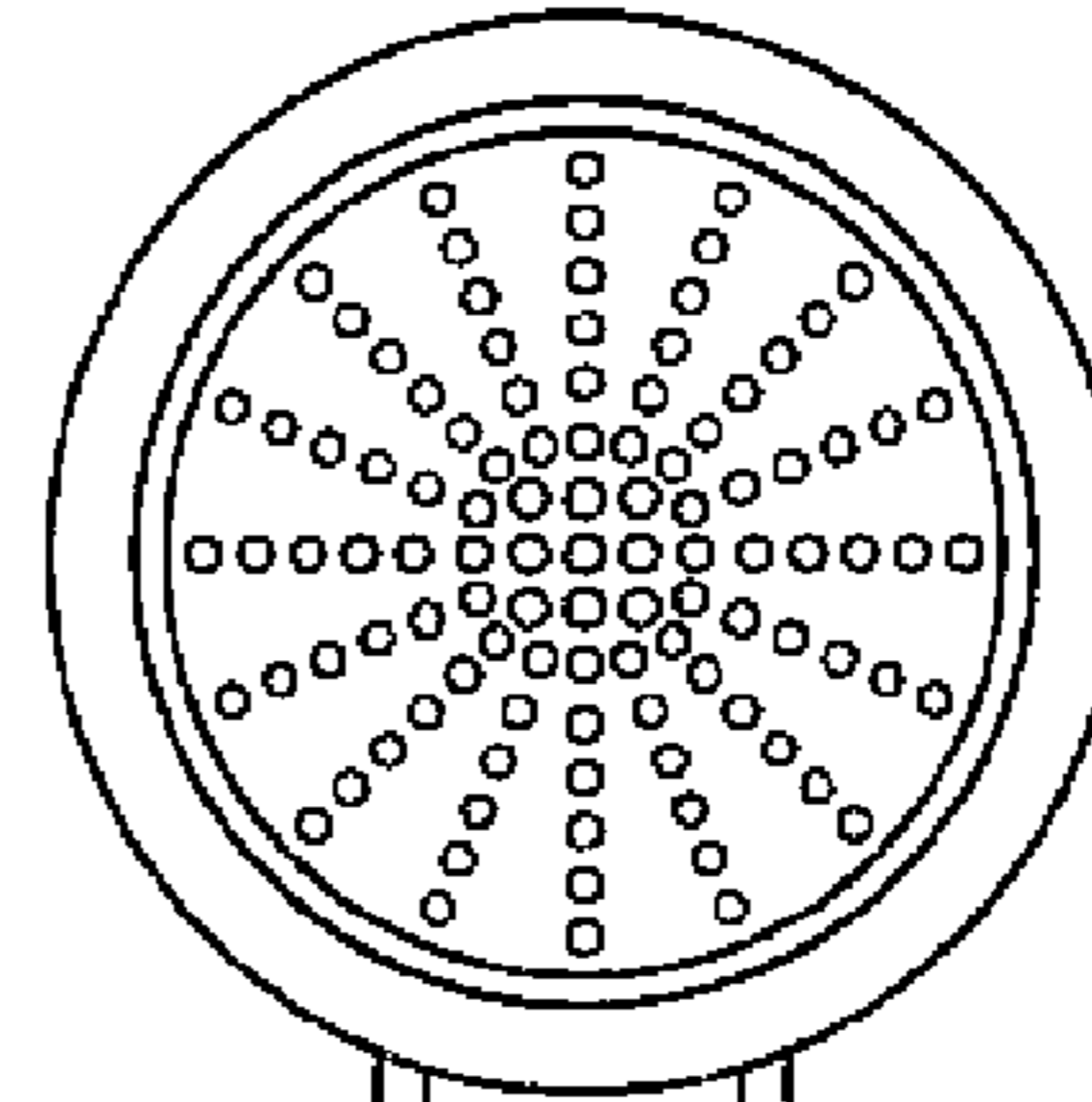
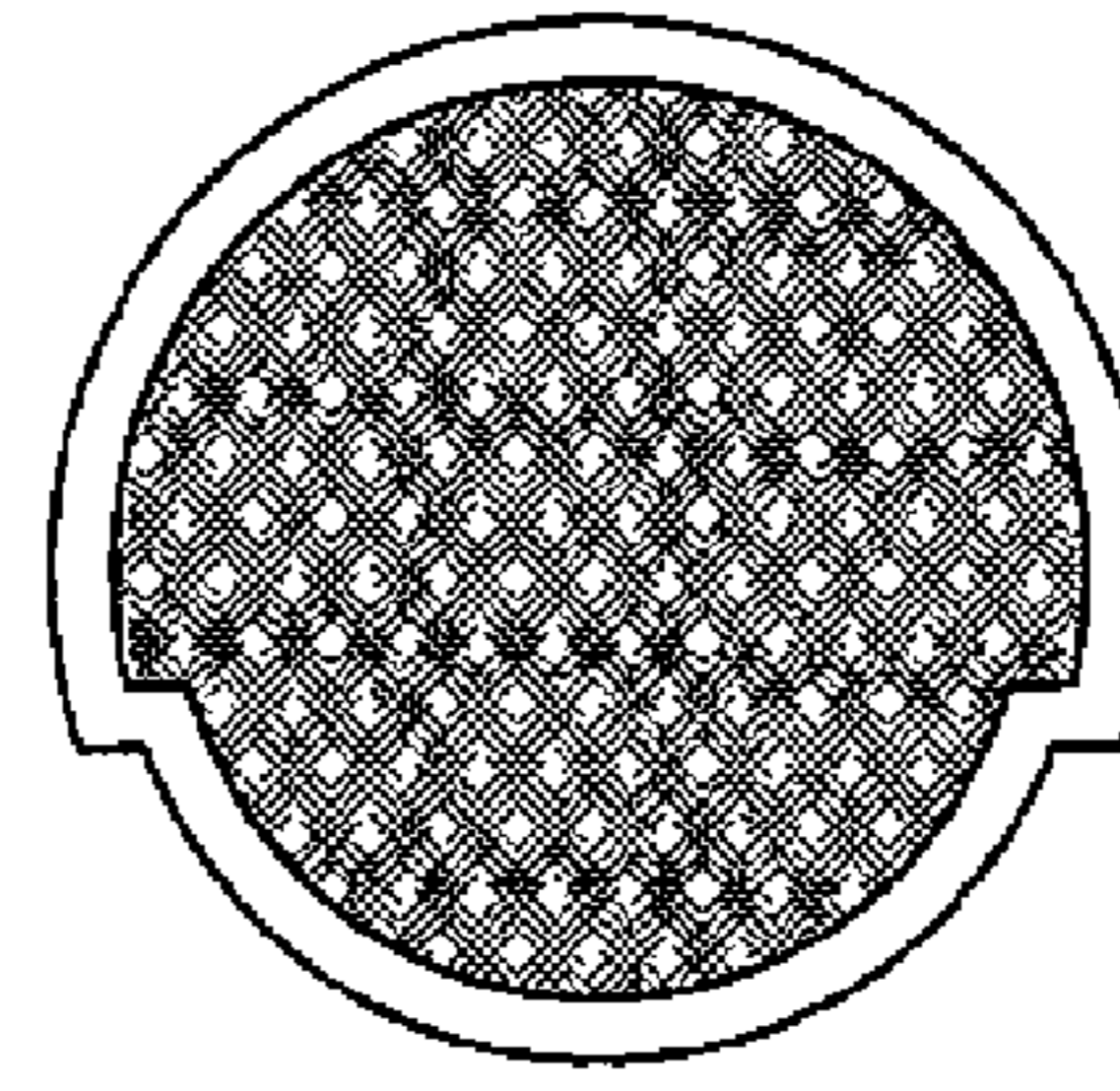

FIG. 10

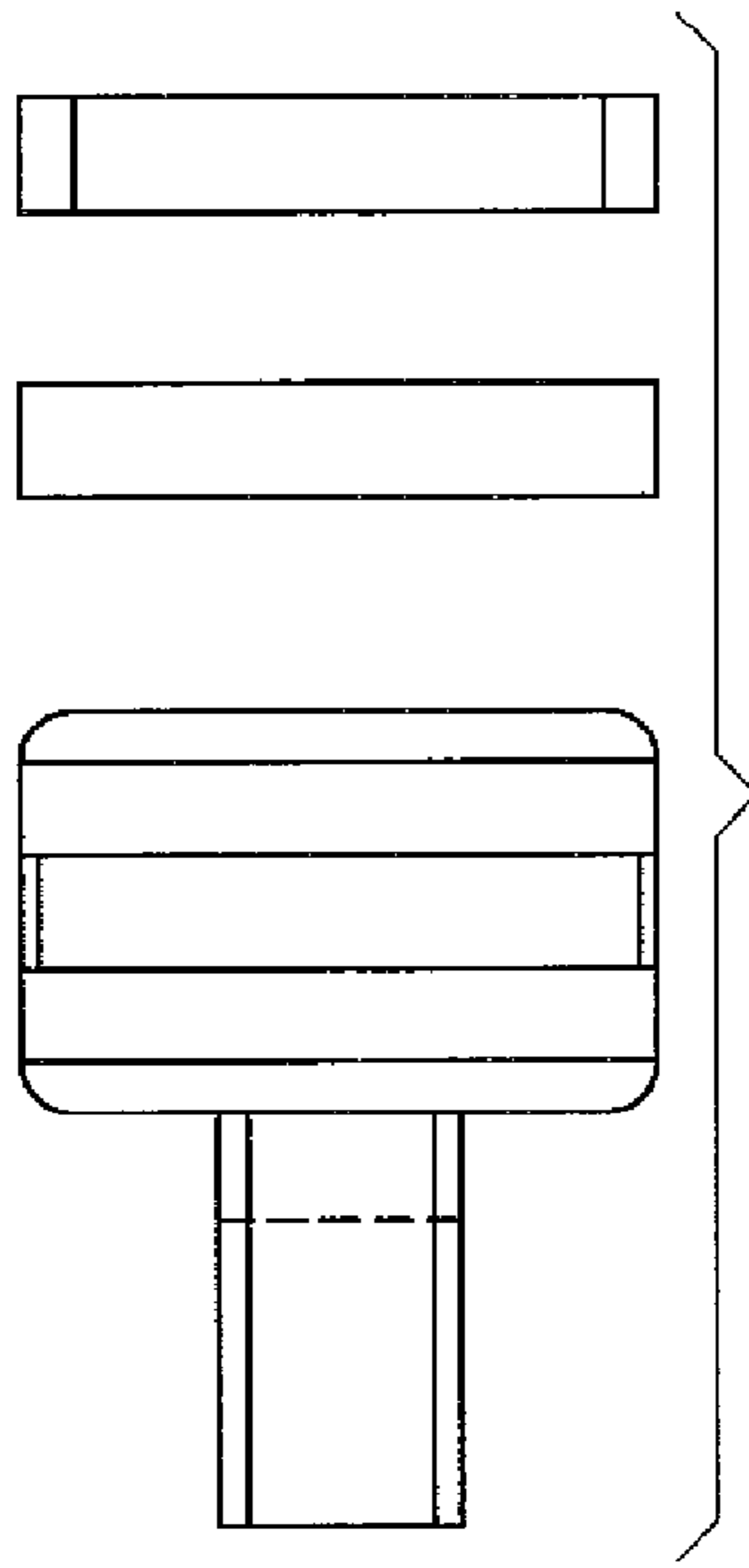

FIG. 11

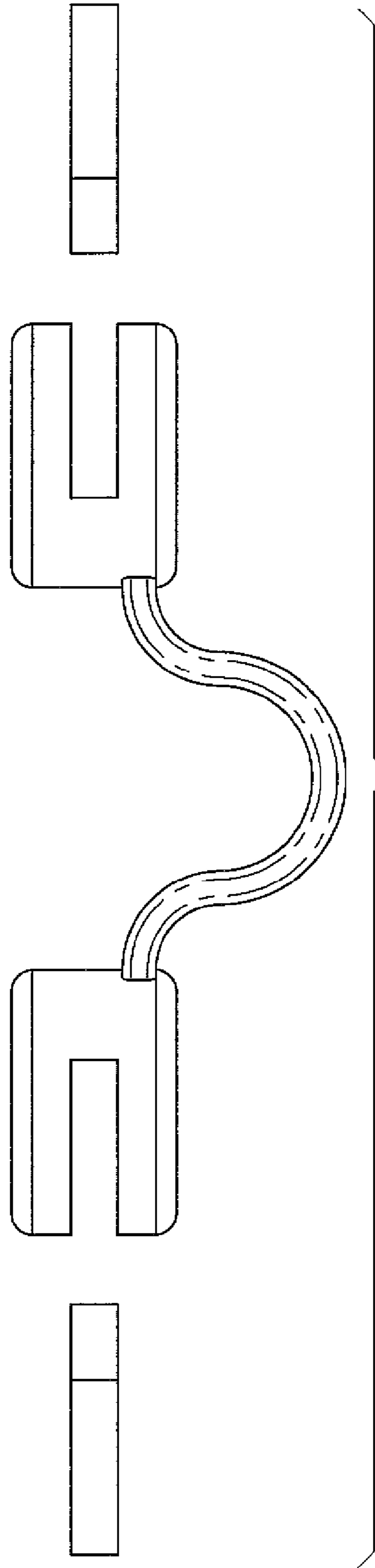

FIG. 12

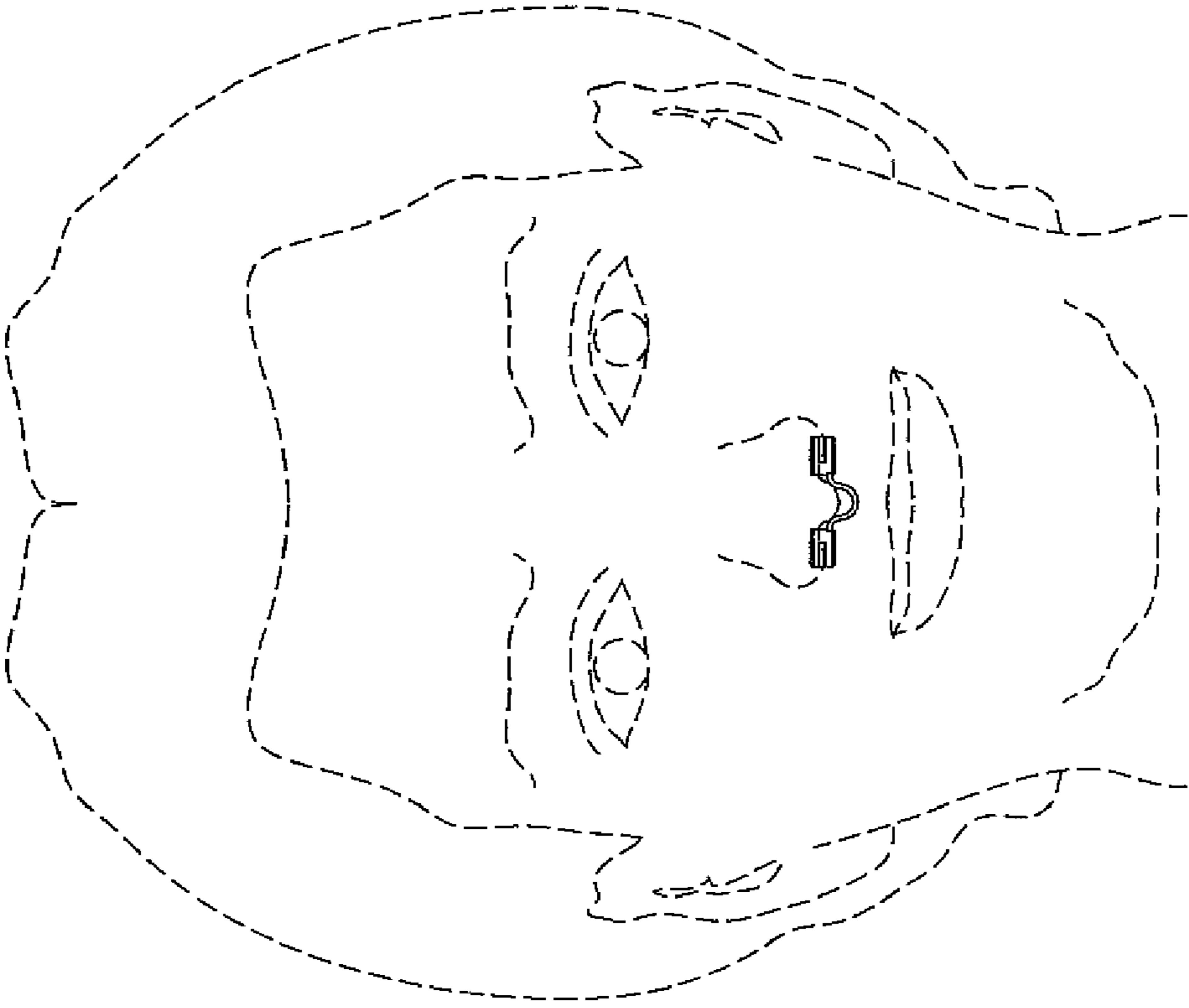

FIG. 13