



US00D627040S

(12) **United States Design Patent**  
**Kehrer et al.**

(10) **Patent No.:** **US D627,040 S**

(45) **Date of Patent:** **\*\* Nov. 9, 2010**

(54) **SINK**

(75) Inventors: **Joachim Kehrer**, Bretten-Bauerbach (DE); **Katherina Pafralidou**, Heilbronn (DE)

(73) Assignee: **Blanco GmbH + Co KG**, Oberderdingen (DE)

(\*\*) Term: **14 Years**

(21) Appl. No.: **29/334,728**

(22) Filed: **Mar. 31, 2009**

(51) **LOC (9) Cl.** ..... **23-02**

(52) **U.S. Cl.** ..... **D23/293.1**

(58) **Field of Classification Search** ..... D23/284-285, D23/293.1, 308; 4/619, 631, 650, 660  
See application file for complete search history.

(56) **References Cited**

**U.S. PATENT DOCUMENTS**

- D505,188 S \* 5/2005 Bayer ..... D23/293.1
- D541,912 S \* 5/2007 Ziemann ..... D23/293.1
- D544,586 S \* 6/2007 Gilbert et al. .... D23/293.1

**OTHER PUBLICATIONS**

Julien, Inc., Home Refinements Specification, dated 2006, Front and Rear Covers and pp. 1-49 (53 pages total). In particular, the Vintage Collection of Undermount Sinks shown on pp. 24-26.

Blanco, Manufacturer's Suggested Price List, listing for Blanco Diamond undermount sinks, 2002, front cover, pp. 58-59, and one additional sheet (4 pages total).

Julien Inc., Vintage Collection Undermount Sinks, Undated Literature, pp. 32-36 (5 pages total).

Blanco, Black Diamond Product Literature, Undated, pp. 39-41 (3 pages).

\* cited by examiner

*Primary Examiner*—Robert A Delehanty

(74) *Attorney, Agent, or Firm*—Hanley, Flight & Zimmerman, LLC.

(57) **CLAIM**

The ornamental design for a “sink,” as shown and described.

**DESCRIPTION**

FIG. 1 is a perspective view of the sink from above;

FIG. 2 is a top plan view of the sink;

FIG. 3 is a bottom plan view of the sink;

FIG. 4 is a front view of the sink;

FIG. 5 is a rear view of the sink;

FIG. 6 is a side view of the sink from the right side; and,

FIG. 7 is a side view of the sink from the left side.

**1 Claim, 7 Drawing Sheets**

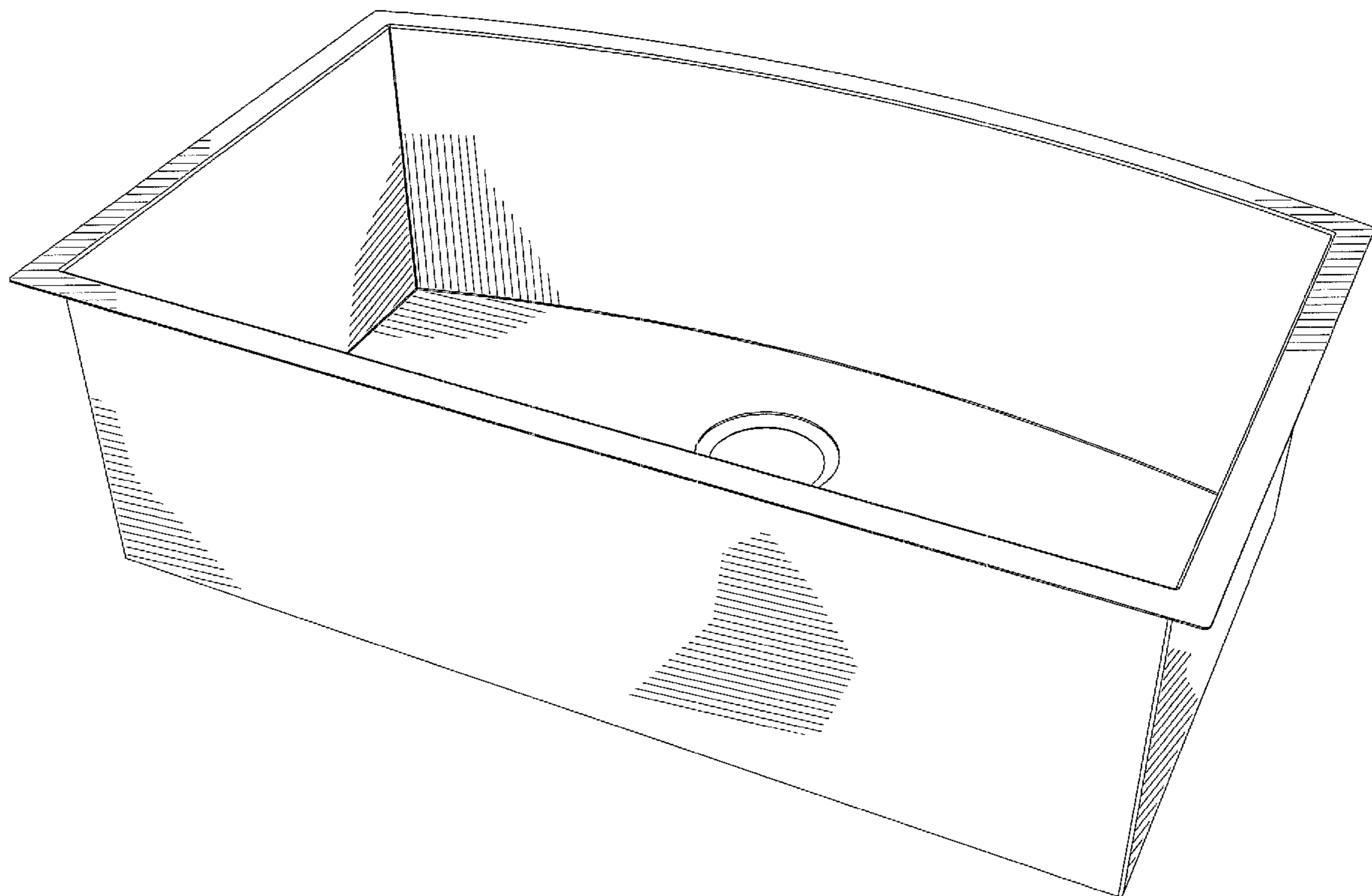

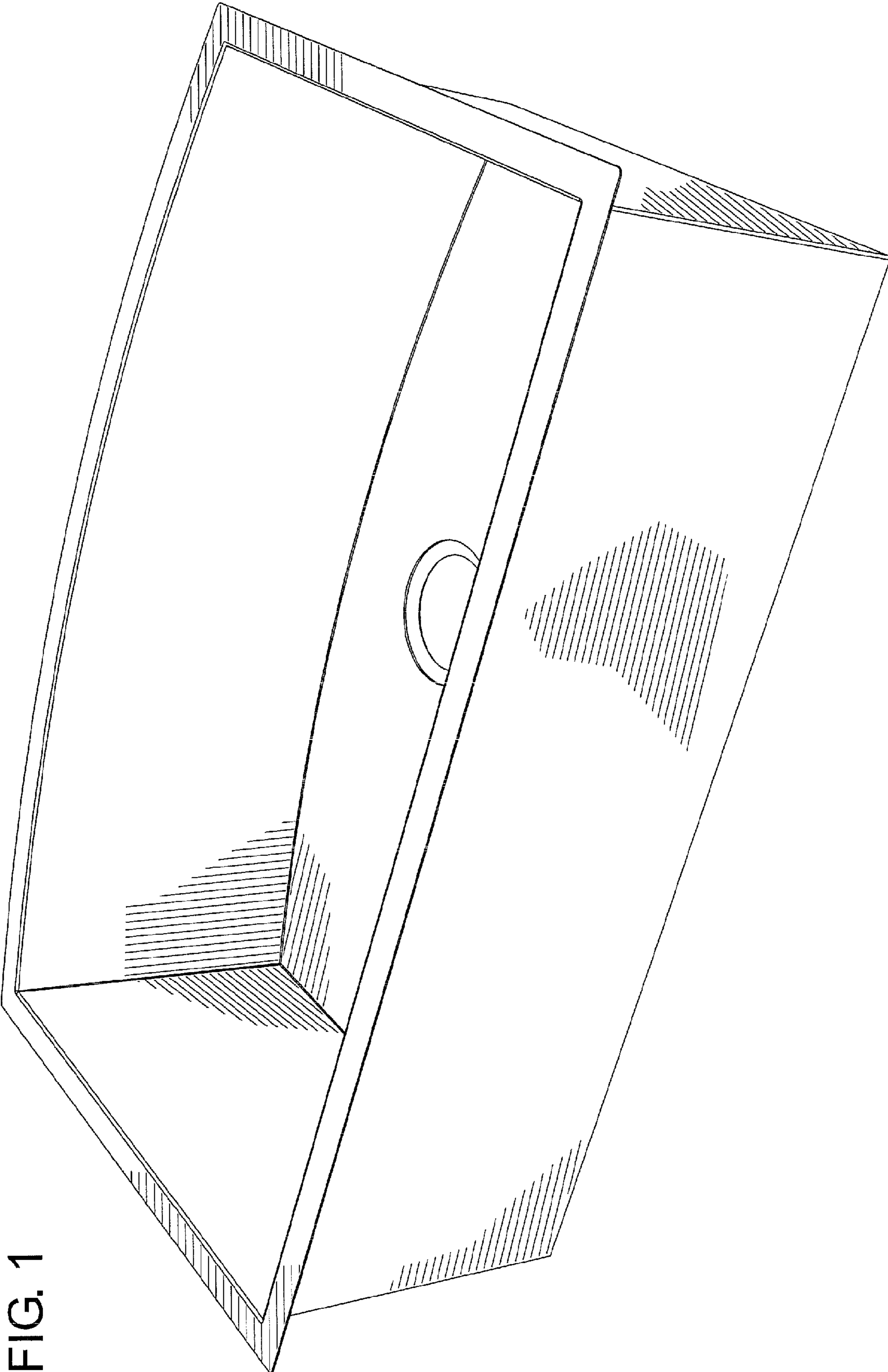

FIG. 1

FIG. 2

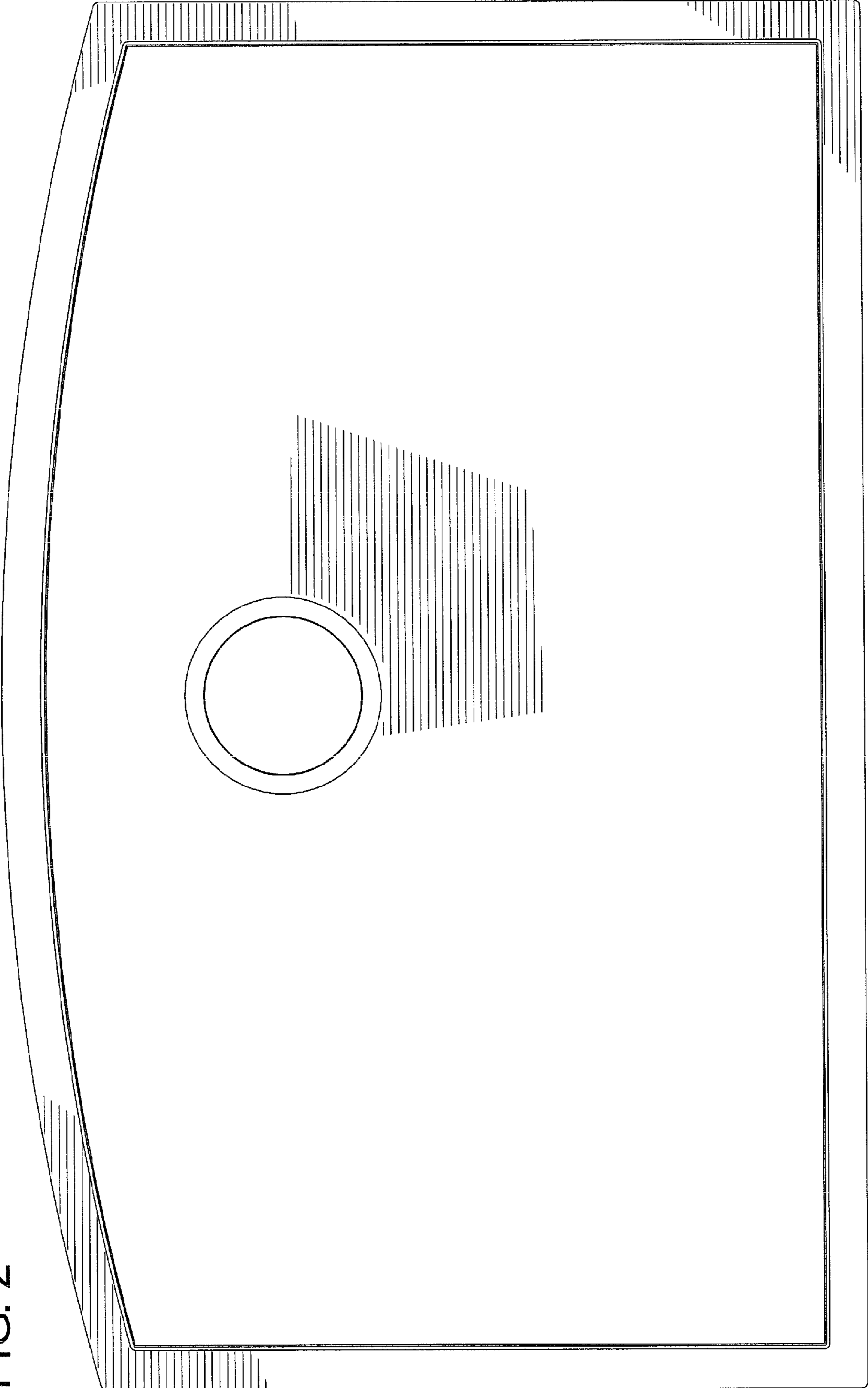

FIG. 3

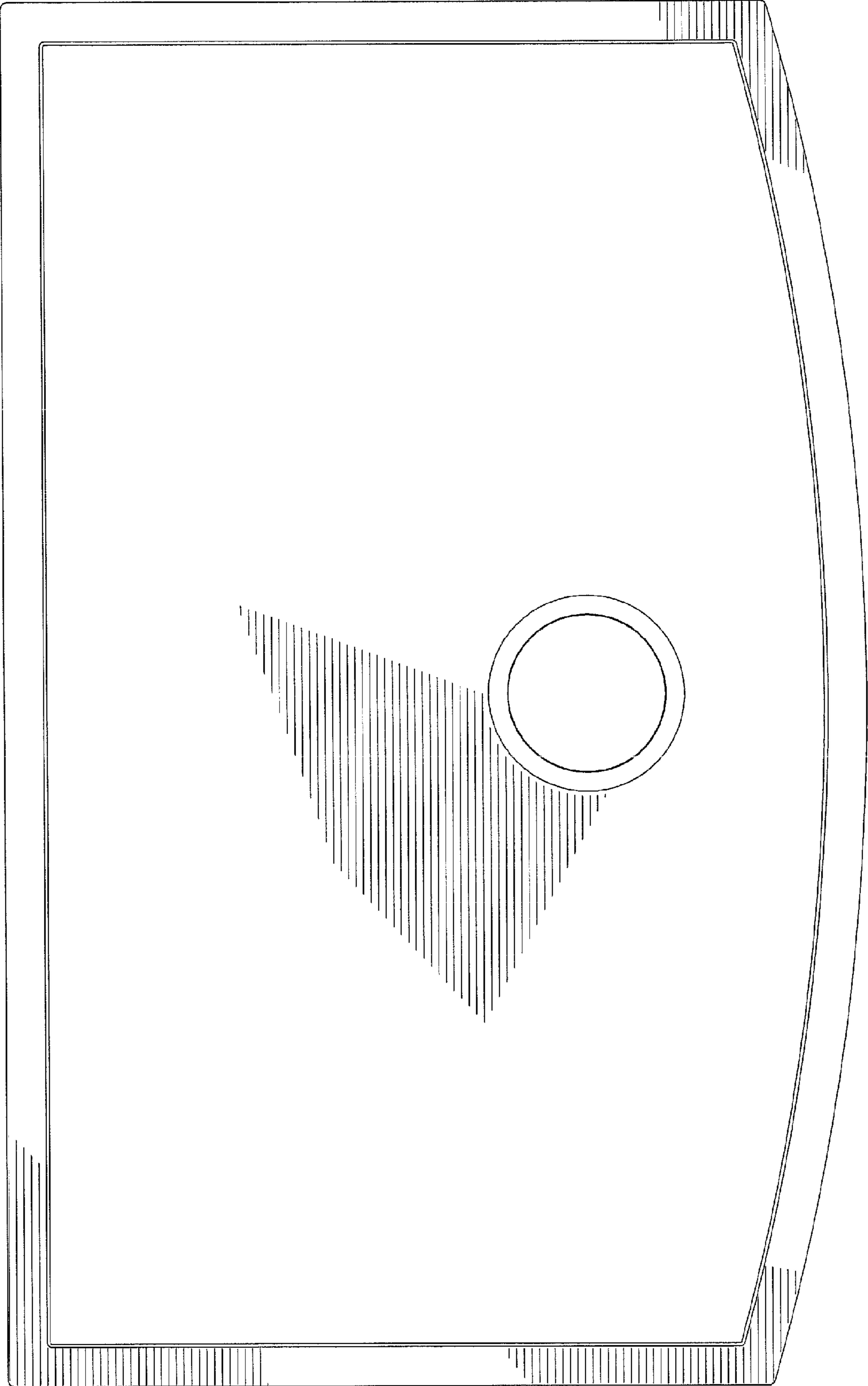

FIG. 4

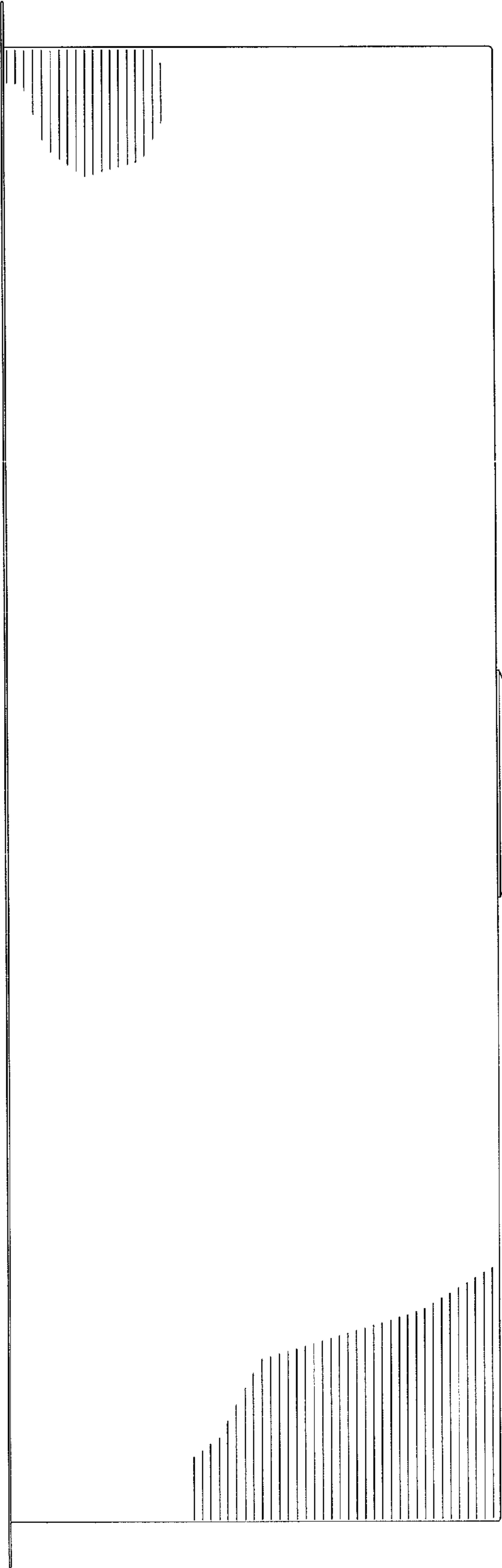
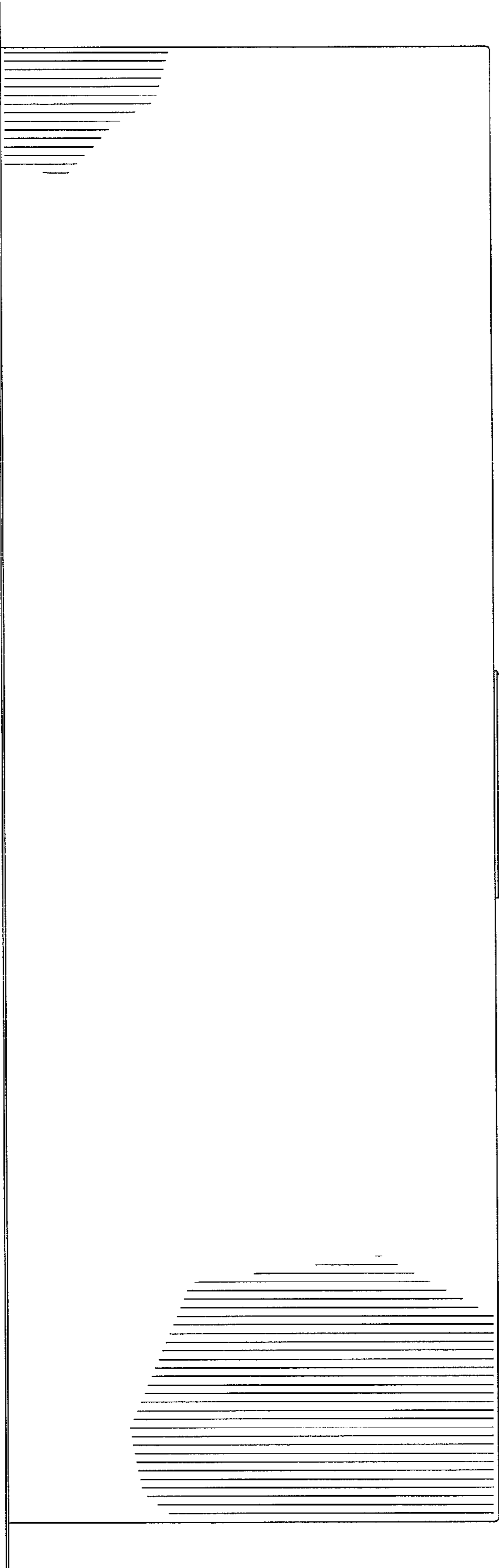

FIG. 5



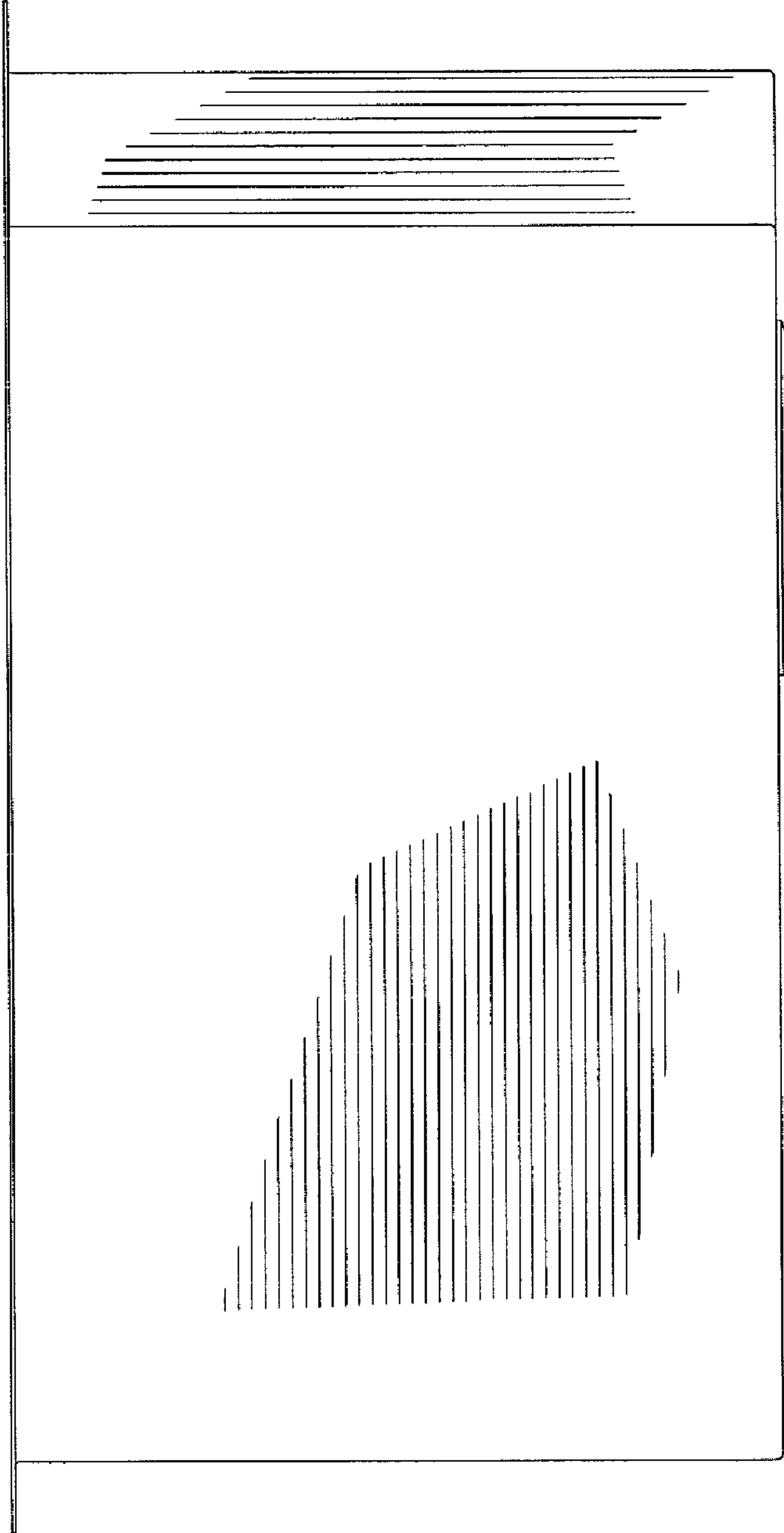

FIG. 6

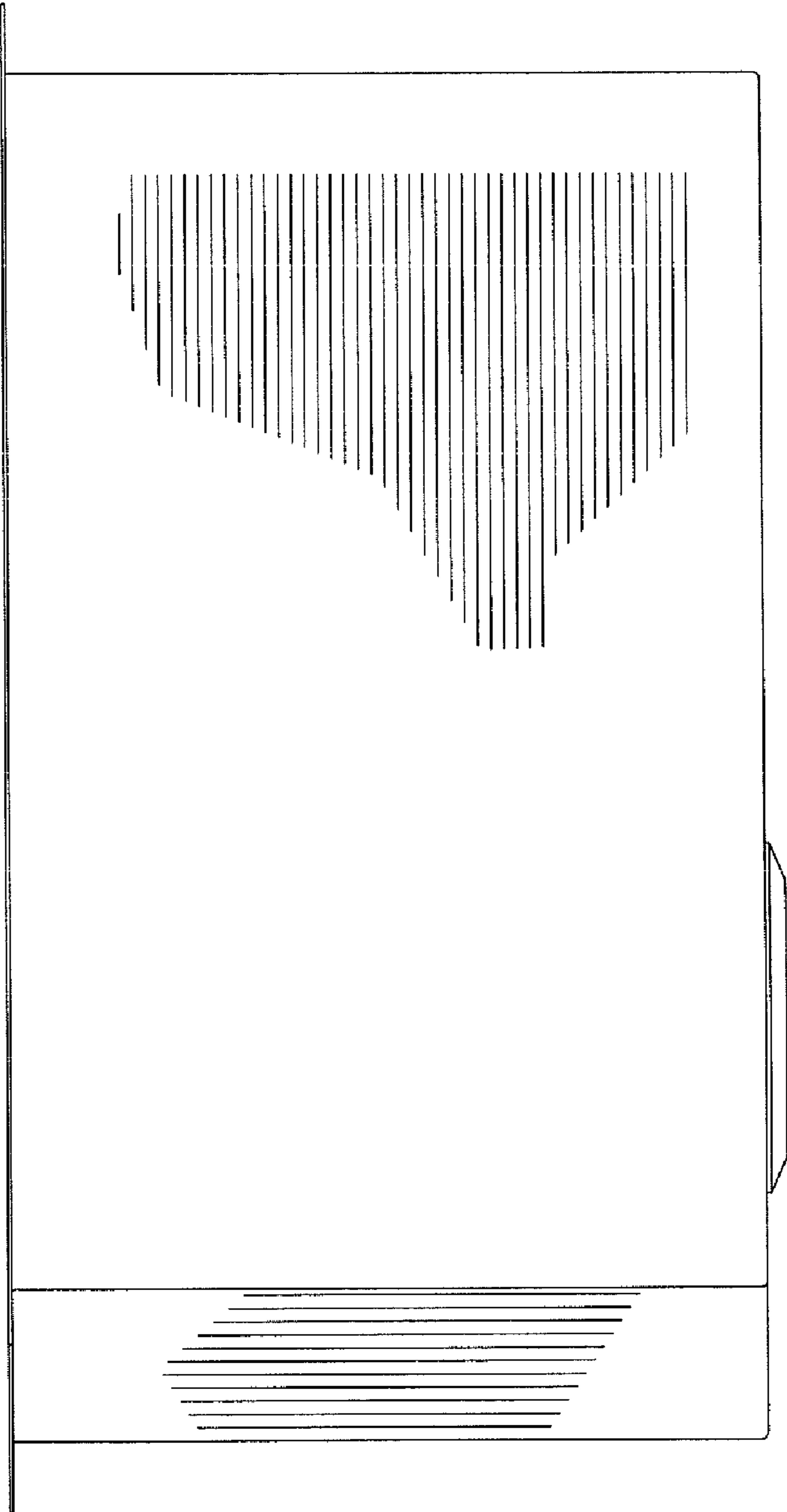

FIG. 7