



US00D626981S

(12) **United States Design Patent**
Okamoto et al.

(10) **Patent No.:** **US D626,981 S**

(45) **Date of Patent:** **** Nov. 9, 2010**

(54) **AUTOMATIC TABLET PACKING MACHINE**

(75) Inventors: **Yasutoshi Okamoto**, Osaka (JP); **Fumio Yamada**, Osaka (JP); **Akihiro Mochizuki**, Osaka (JP)

(73) Assignee: **Sanyo Electric Co., Ltd.**, Osaka (JP)

(**) Term: **14 Years**

(21) Appl. No.: **29/347,760**

(22) Filed: **May 19, 2010**

(30) **Foreign Application Priority Data**

Dec. 14, 2009 (JP) 2009-028998

(51) **LOC (9) Cl.** **15-99**

(52) **U.S. Cl.** **D15/145**

(58) **Field of Classification Search** D6/436,
D6/441, 445, 446, 448, 455, 559, 561; D15/145;
D18/50, 53, 55; D20/4, 5; 53/131.4, 167,
53/202, 279, 284.5, 284.7, 370.7, 370.9,
53/381.1, 426, 550, 563, 565; 493/184
See application file for complete search history.

(56) **References Cited**

U.S. PATENT DOCUMENTS

D365,224 S *	12/1995	Pohlman	D6/445
D377,721 S *	2/1997	Pohlman	D6/436
D410,230 S *	5/1999	Witte	D14/371
D413,141 S *	8/1999	Matsumoto	D18/55
D424,101 S *	5/2000	Takeuchi	D18/53
D431,934 S *	10/2000	Chininis	D6/446
D443,305 S *	6/2001	Stettes et al.	D20/5
D468,755 S *	1/2003	Muniz-Rivera et al.	D15/81
D492,507 S *	7/2004	Moon et al.	D6/446
D506,090 S *	6/2005	Ben-Or	D6/448
D517,805 S *	3/2006	Hosking	D3/295

7,028,447 B2 *	4/2006	Sung	53/131.5
D535,494 S *	1/2007	Bixby et al.	D6/446
D543,222 S *	5/2007	Pester et al.	D15/145
D552,166 S *	10/2007	Ohashi	D18/50
D563,692 S *	3/2008	DeCarlo et al.	D6/448
D567,272 S *	4/2008	Okamoto et al.	D15/145
7,428,805 B2 *	9/2008	Kim	53/131.4
D613,319 S *	4/2010	Okamoto et al.	D15/145
2005/0122010 A1 *	6/2005	Kobayashi et al.	312/209
2006/0021299 A1 *	2/2006	Jones	53/461
2007/0151204 A1 *	7/2007	Kim	53/55
2007/0274042 A1 *	11/2007	Jackson et al.	361/695

* cited by examiner

Primary Examiner—Patricia Palasik

(74) *Attorney, Agent, or Firm*—Rabin & Berdo, PC

(57) **CLAIM**

The ornamental design for an automatic tablet packing machine, as shown and described.

DESCRIPTION

FIG. 1 is a perspective view of an automatic tablet packing machine showing our new design;

FIG. 2 is a front elevation view thereof;

FIG. 3 is a rear elevation view thereof;

FIG. 4 is a top plan view thereof;

FIG. 5 is a bottom plan view thereof;

FIG. 6 is a right side view thereof;

FIG. 7 is a left side view thereof; and,

FIG. 8 is another perspective view thereof showing a state with a cover and a door open, the tablet cases, one of which is pulled out, are shown in broken lines forming no part of the claimed design.

1 Claim, 8 Drawing Sheets

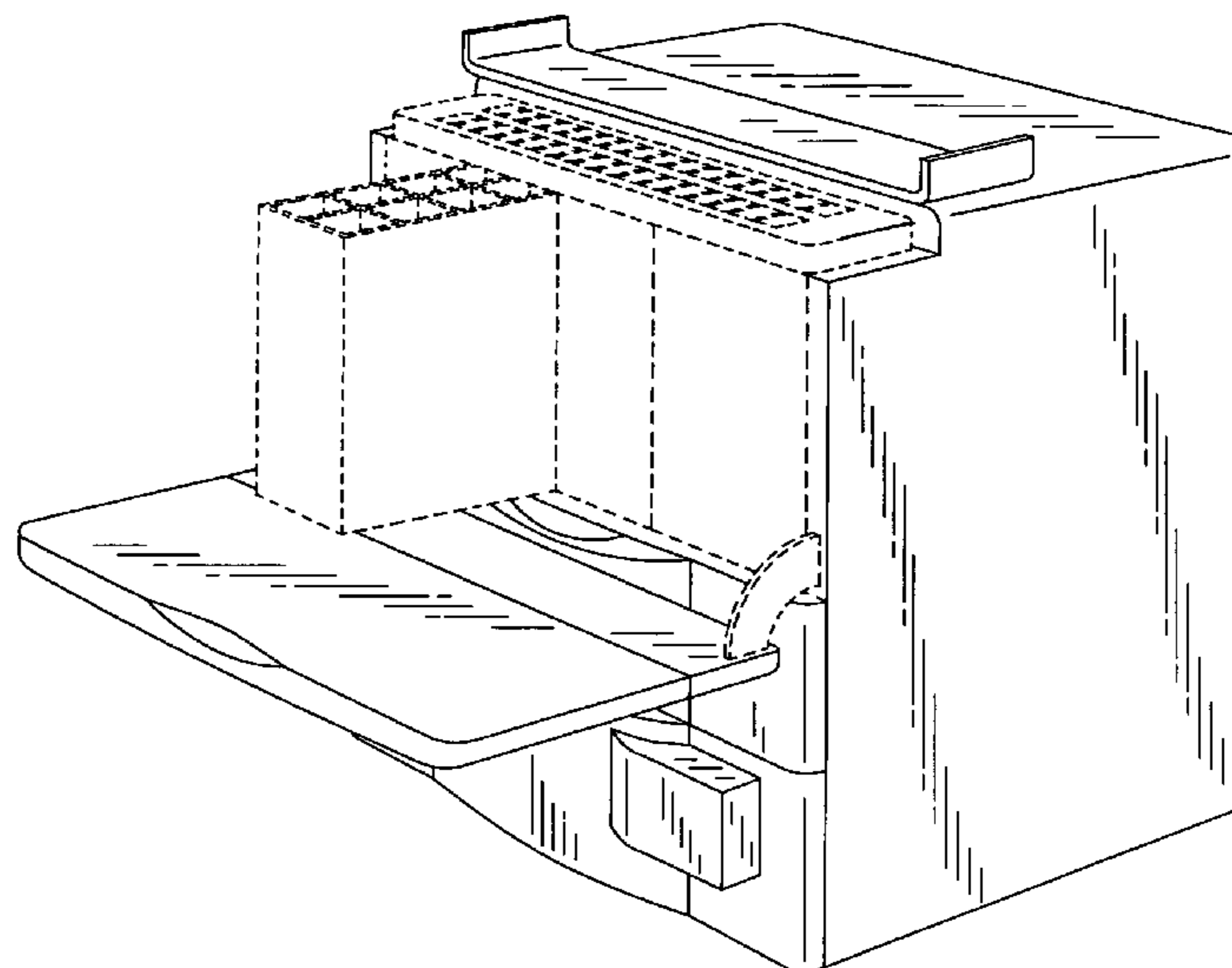
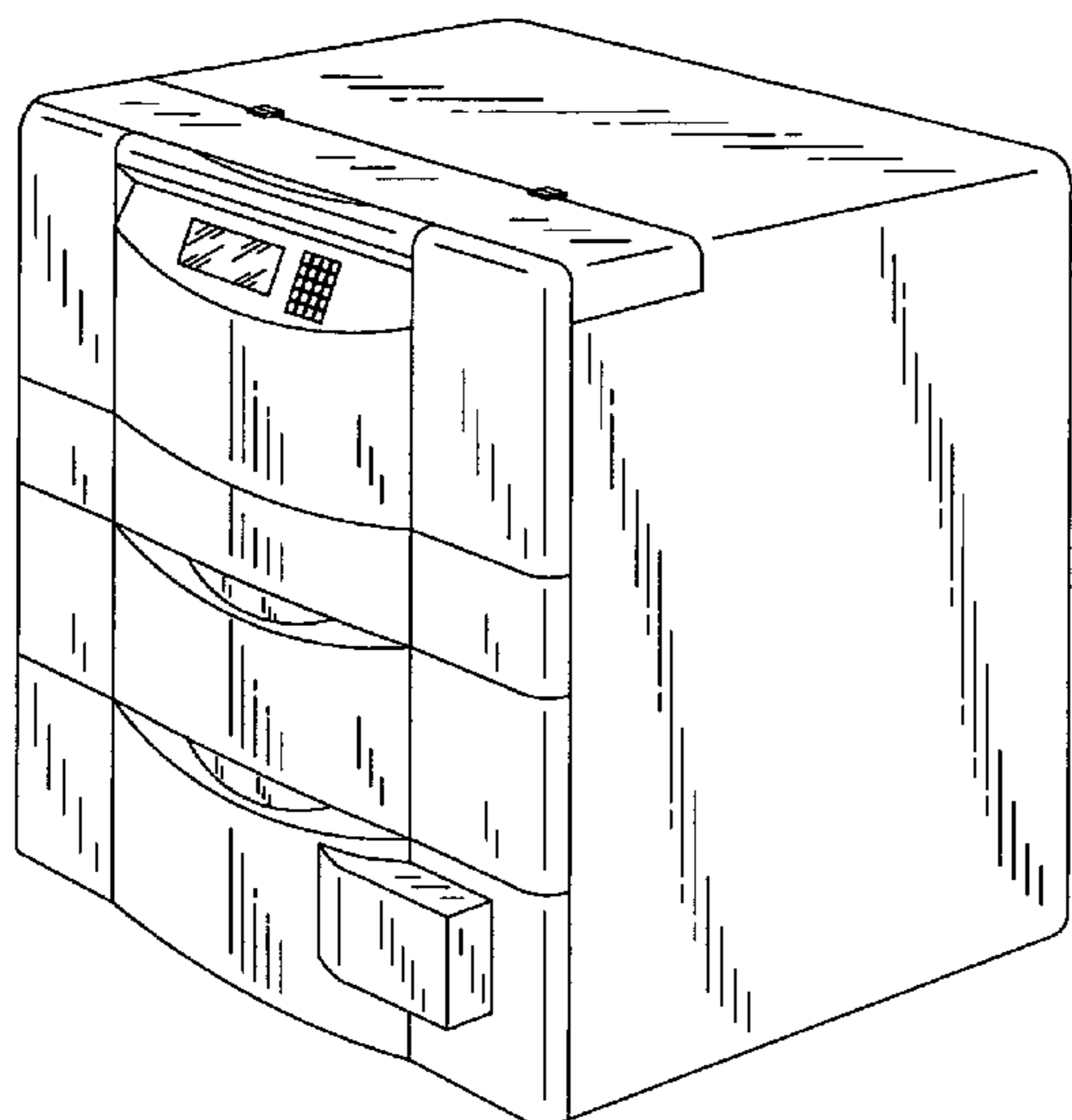

FIG. 1

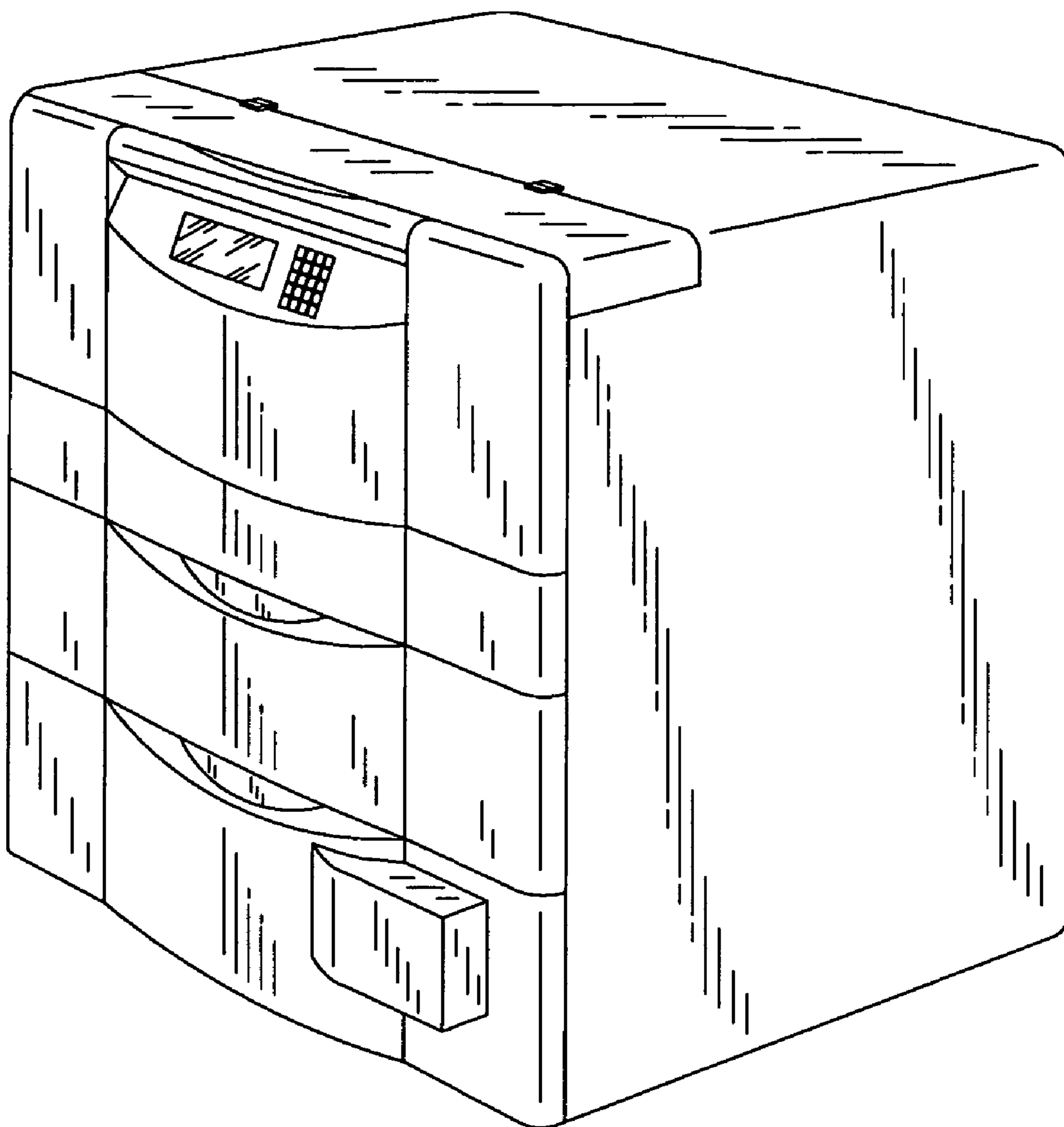

FIG. 2

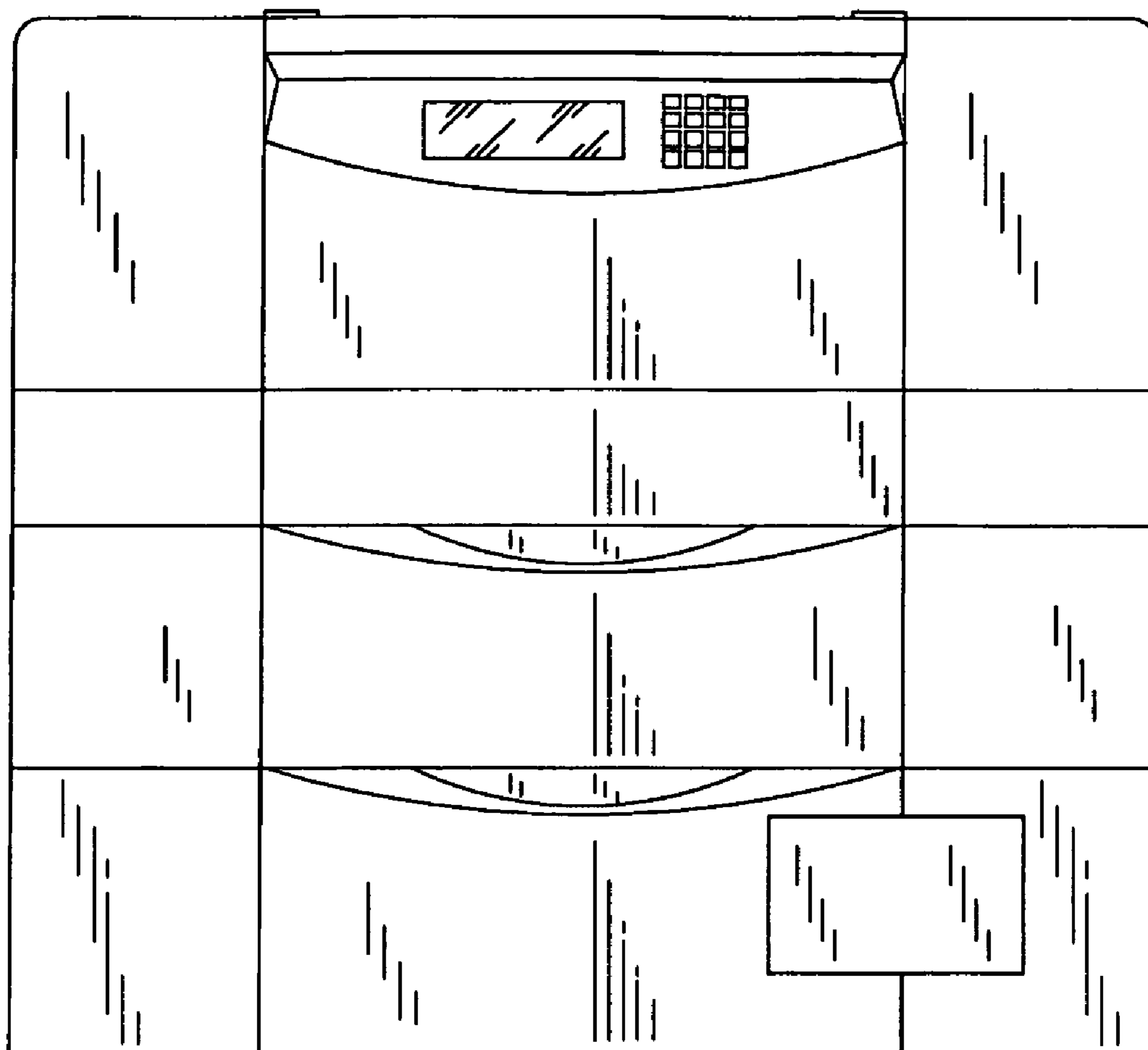

FIG. 3

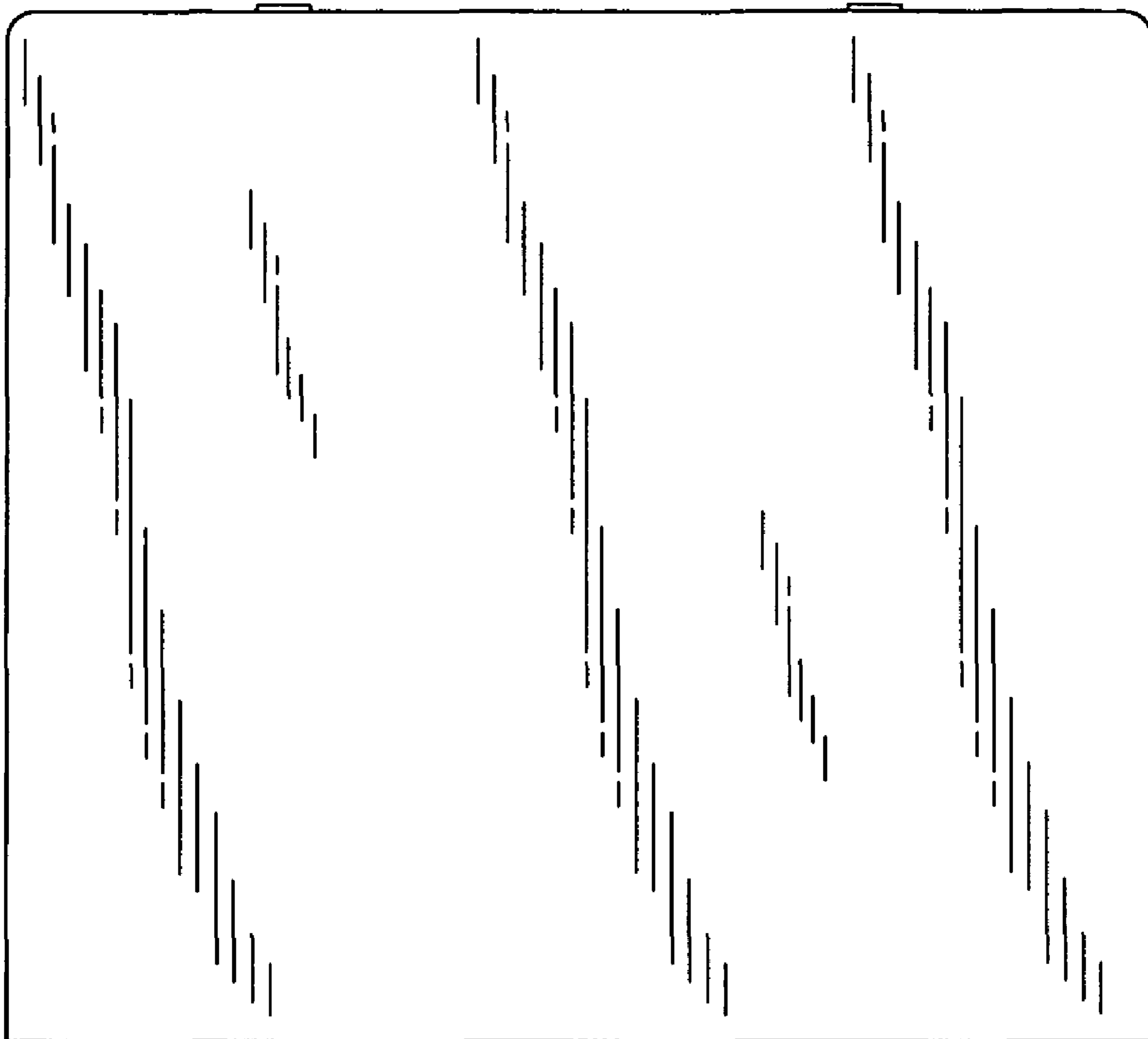

FIG. 4

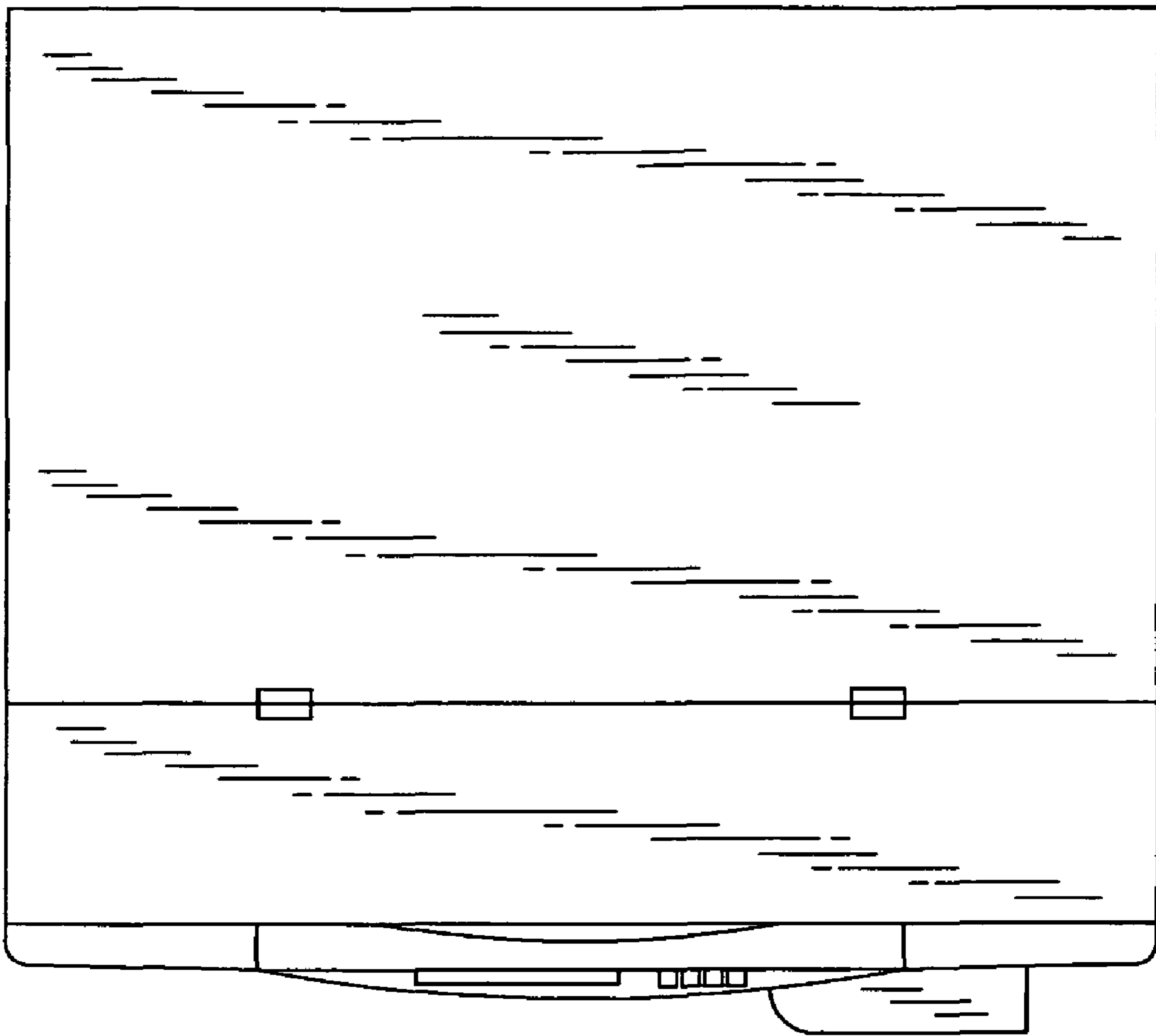

FIG. 5

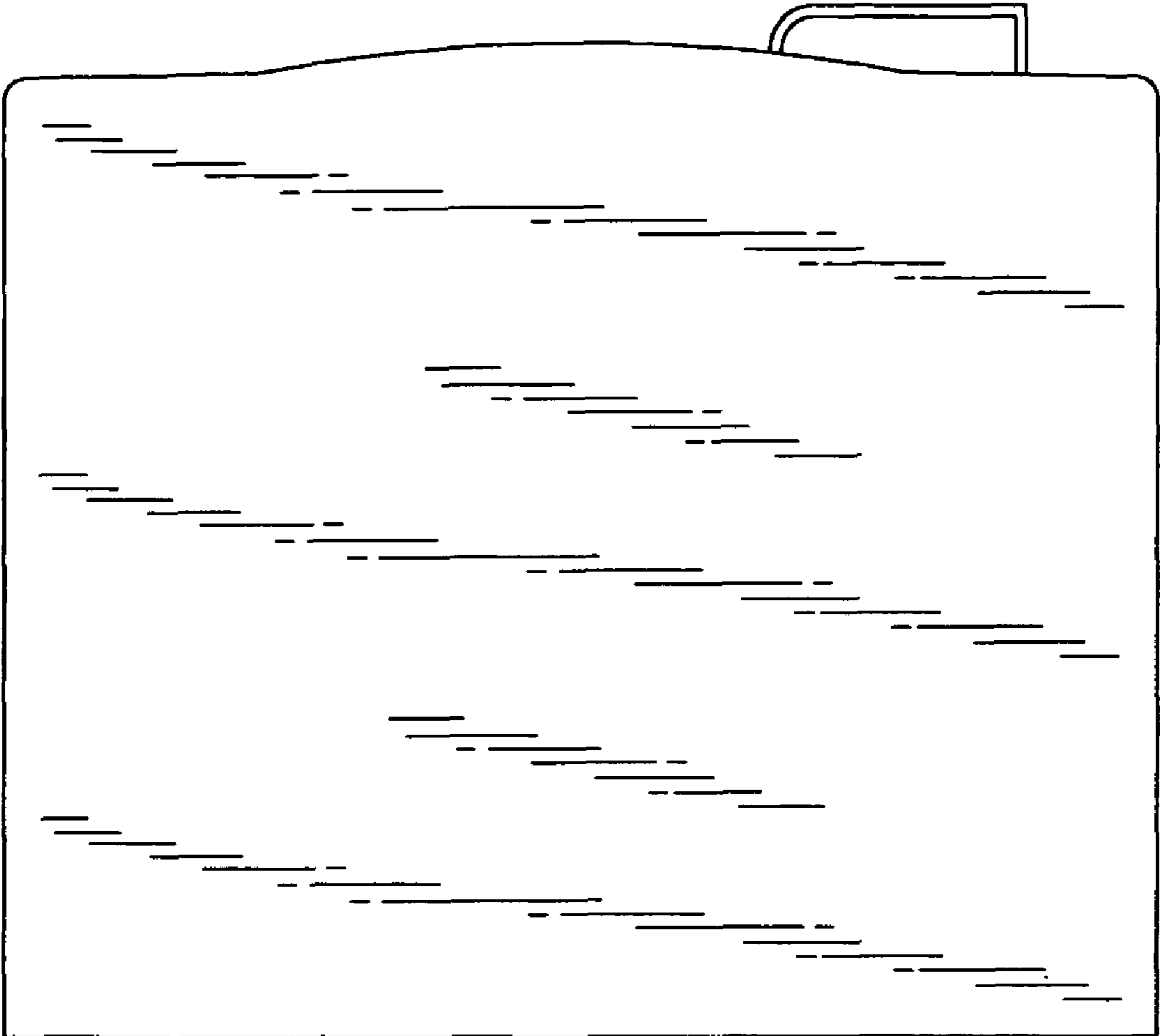

FIG. 6

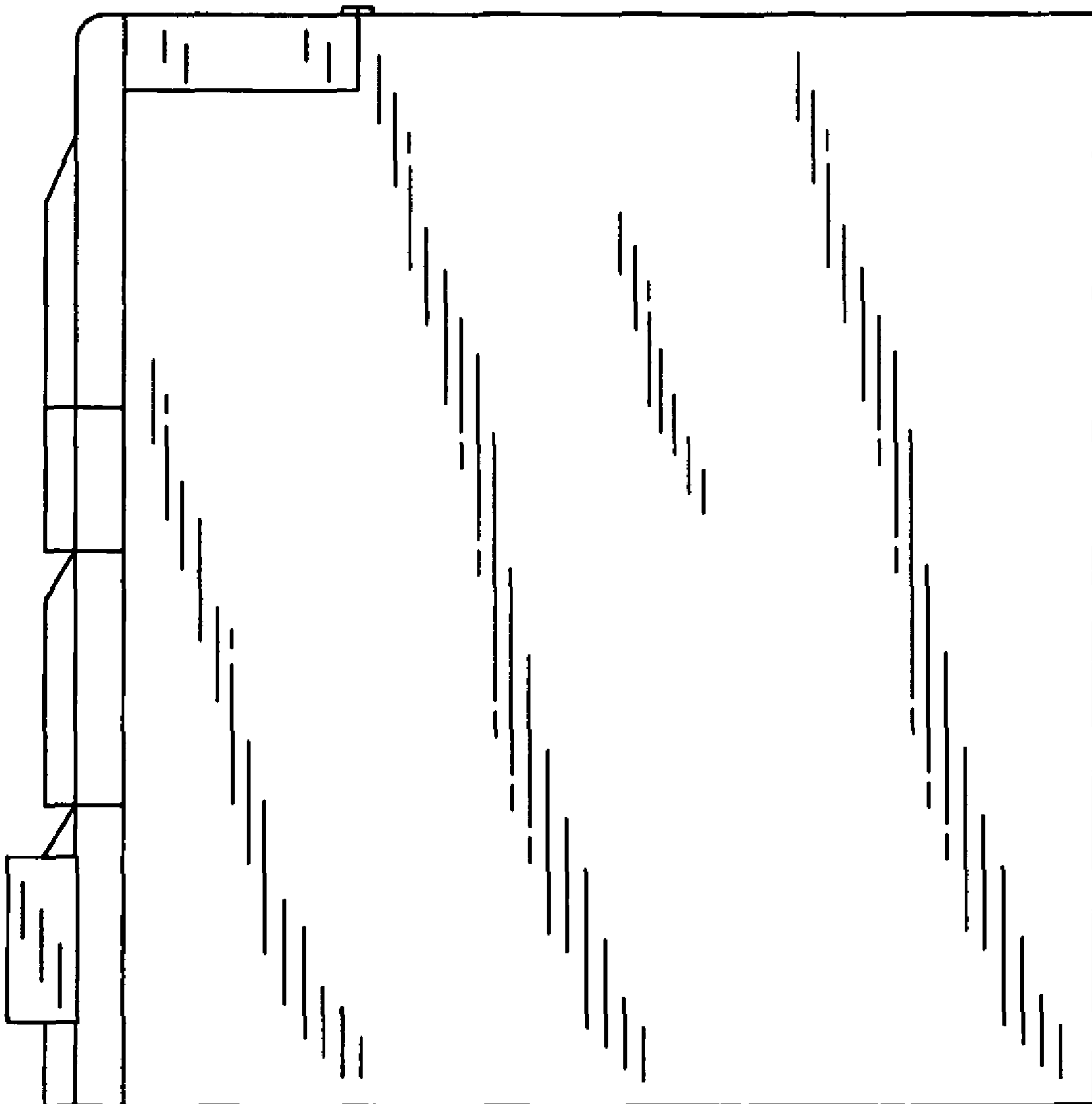

FIG. 7

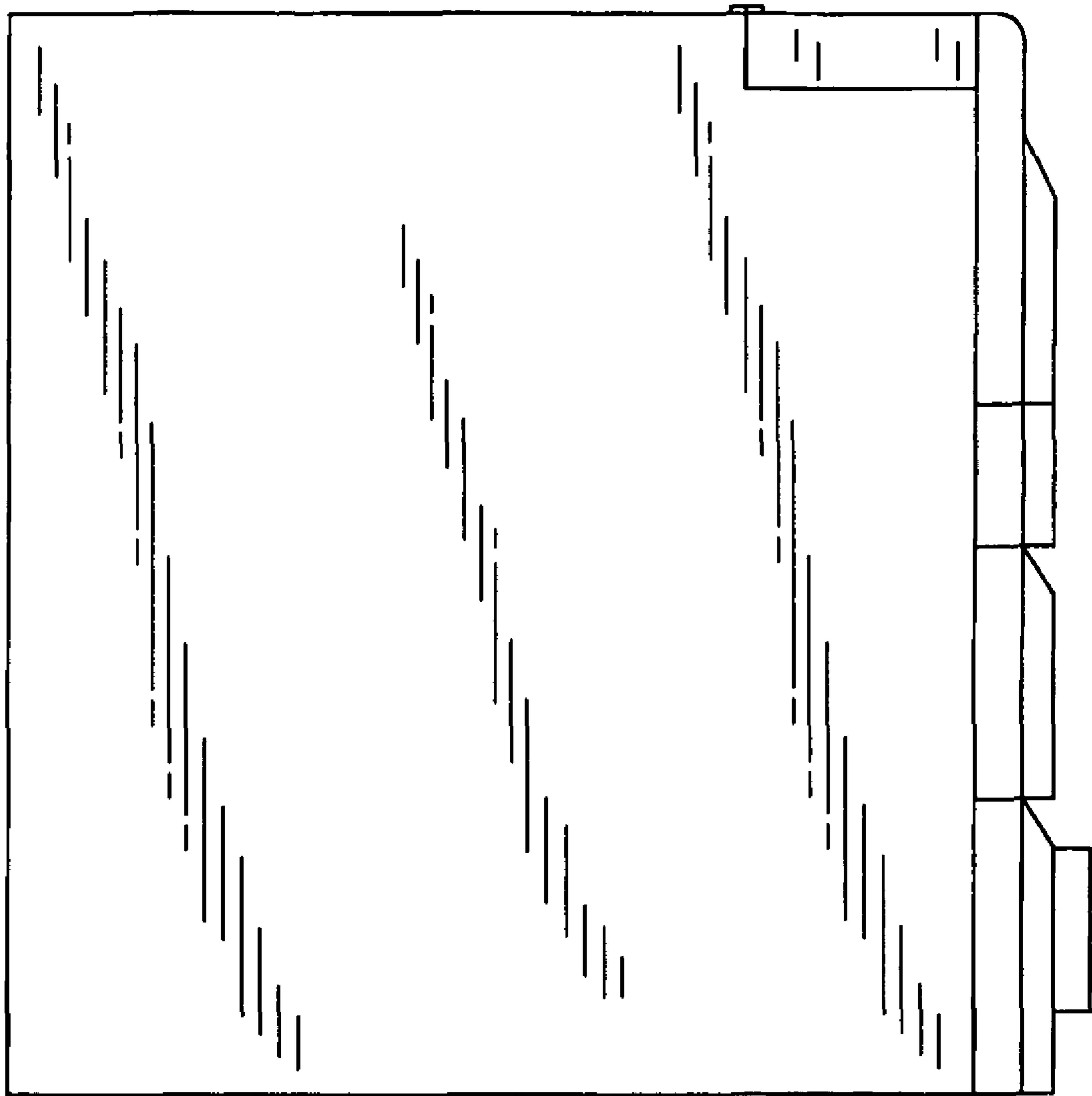

FIG. 8

