



US00D626956S

(12) **United States Design Patent**  
**Hsu**

(10) **Patent No.:** **US D626,956 S**

(45) **Date of Patent:** **\*\* Nov. 9, 2010**

(54) **ALL-IN-ONE PERSONAL COMPUTER**

(75) Inventor: **Kai-Chieh Hsu**, Zhonghe (TW)

(73) Assignee: **Top Victory Investments Ltd.**, Harbour (HK)

(\*\*) Term: **14 Years**

(21) Appl. No.: **29/353,195**

(22) Filed: **Jan. 5, 2010**

(51) **LOC (9) Cl.** ..... **14-02**

(52) **U.S. Cl.** ..... **D14/337**

(58) **Field of Classification Search** ..... D14/371–375,  
D14/126–129, 315, 318, 336, 337; 341/12;  
345/104, 156, 168, 173, 87, 901–905; 348/180,  
348/184, 373, 739; 349/1, 2, 58, 62; 248/917–924  
See application file for complete search history.

(56) **References Cited**

**U.S. PATENT DOCUMENTS**

D403,670 S *	1/1999	Liao	.....	D14/375
D438,201 S *	2/2001	Ogawa et al.	.....	D14/336
D494,163 S *	8/2004	Ishii	.....	D14/337
D496,035 S *	9/2004	Chen et al.	.....	D14/337
D539,797 S *	4/2007	Chiang et al.	.....	D14/337
D543,978 S *	6/2007	Kawase	.....	D14/337
D563,405 S *	3/2008	Taniho et al.	.....	D14/336
D569,864 S *	5/2008	Chen	.....	D14/337

\* cited by examiner

*Primary Examiner*—Freda S Nunn

(74) *Attorney, Agent, or Firm*—Alan Kamrath; Kamrath & Associates PA

(57) **CLAIM**

The ornamental design for all-in-one personal computer, as shown and described.

**DESCRIPTION**

FIG. 1 is a perspective view of a all-in-one personal computer showing my new design;

FIG. 2 is a front side elevational view thereof;

FIG. 3 is a rear side elevational view thereof;

FIG. 4 is a left elevational view thereof;

FIG. 5 is a right elevational view thereof;

FIG. 6 is a top plan view thereof;

FIG. 7 is a bottom plan view thereof;

FIG. 8 is a rear perspective view thereof;

FIG. 9 is a cross-sectional view thereof taken along line 9—9 of FIG. 2; and,

FIG. 10 is another side view thereof with the display shown in an alternate position.

**1 Claim, 10 Drawing Sheets**

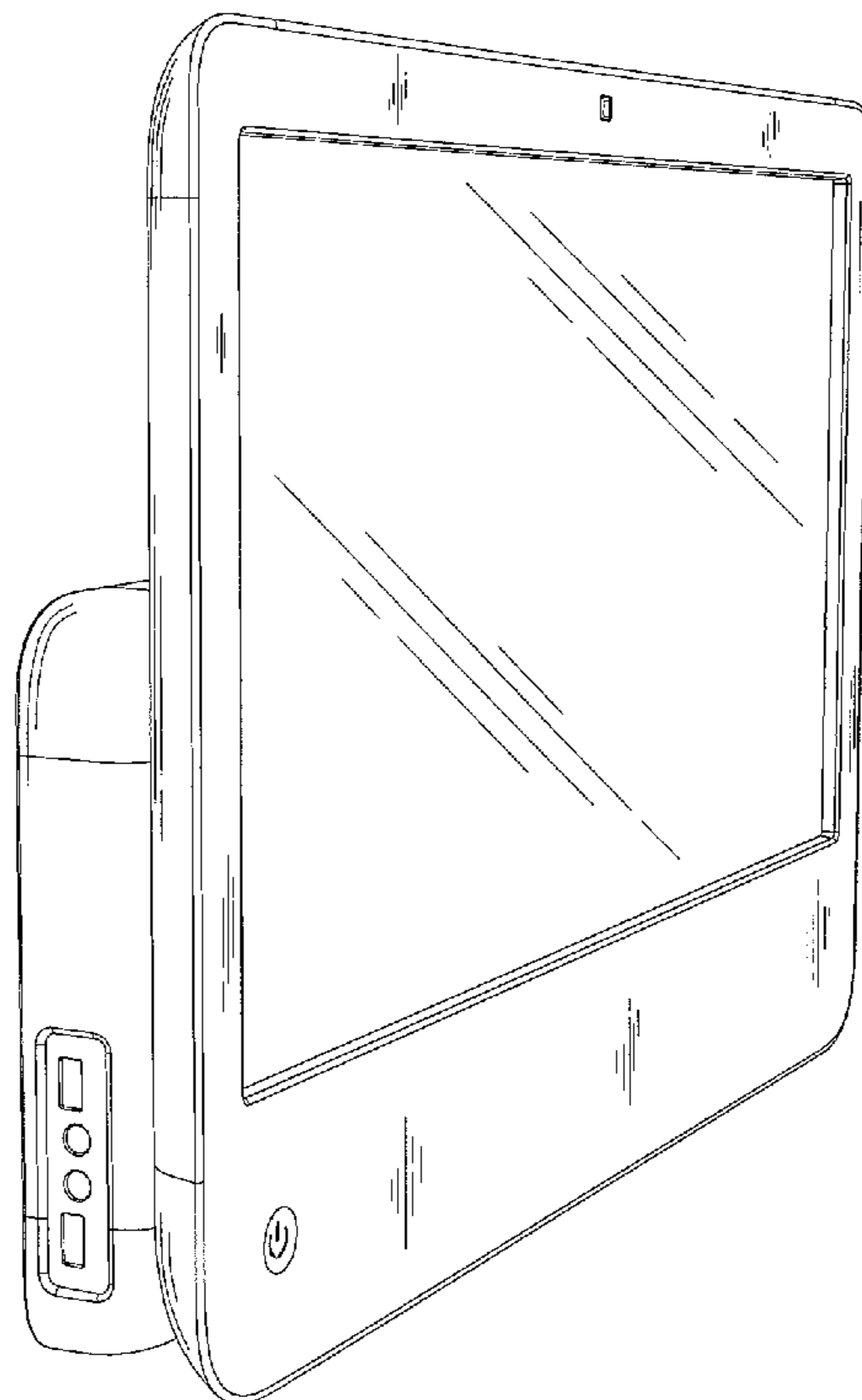

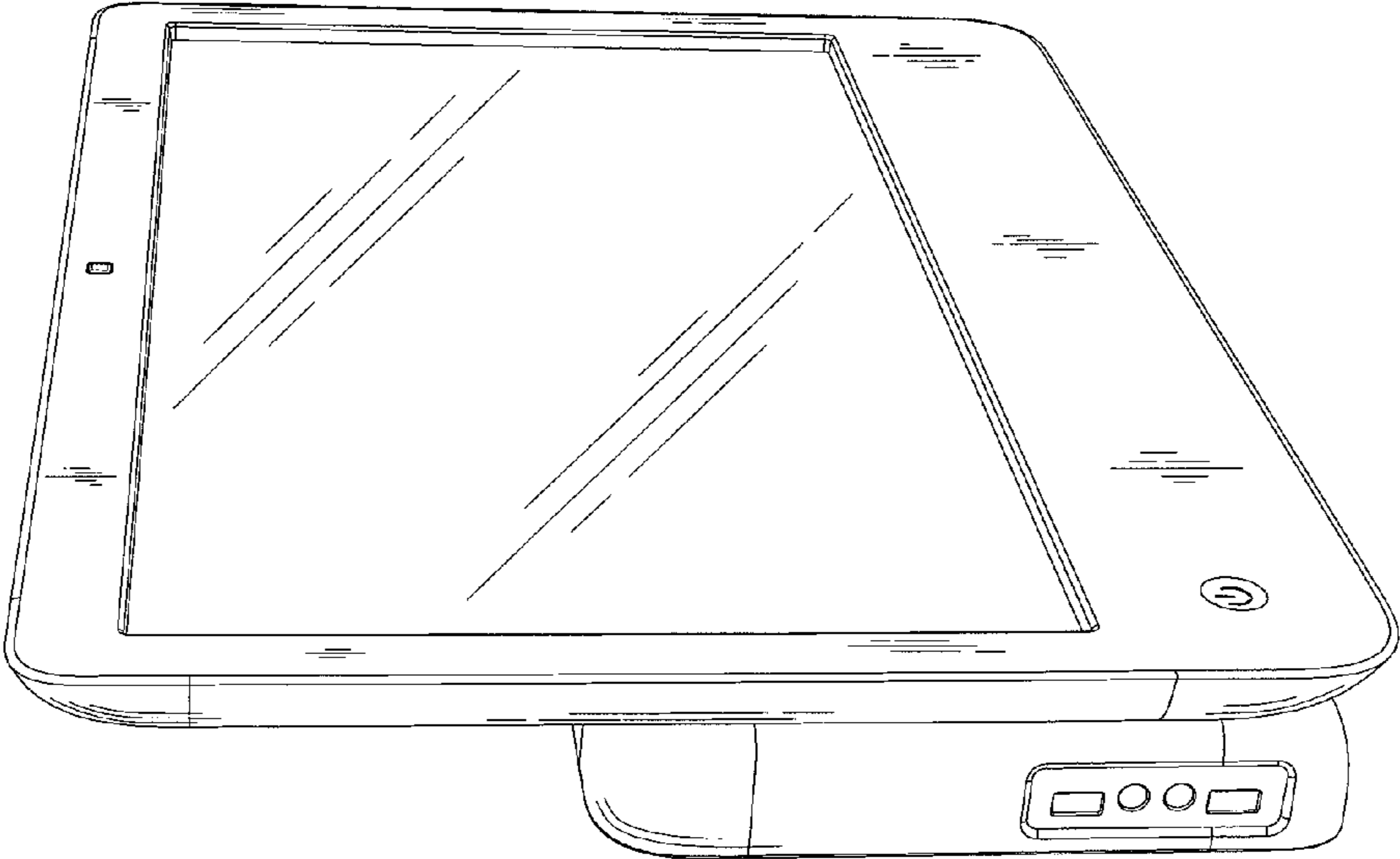

FIG. 1

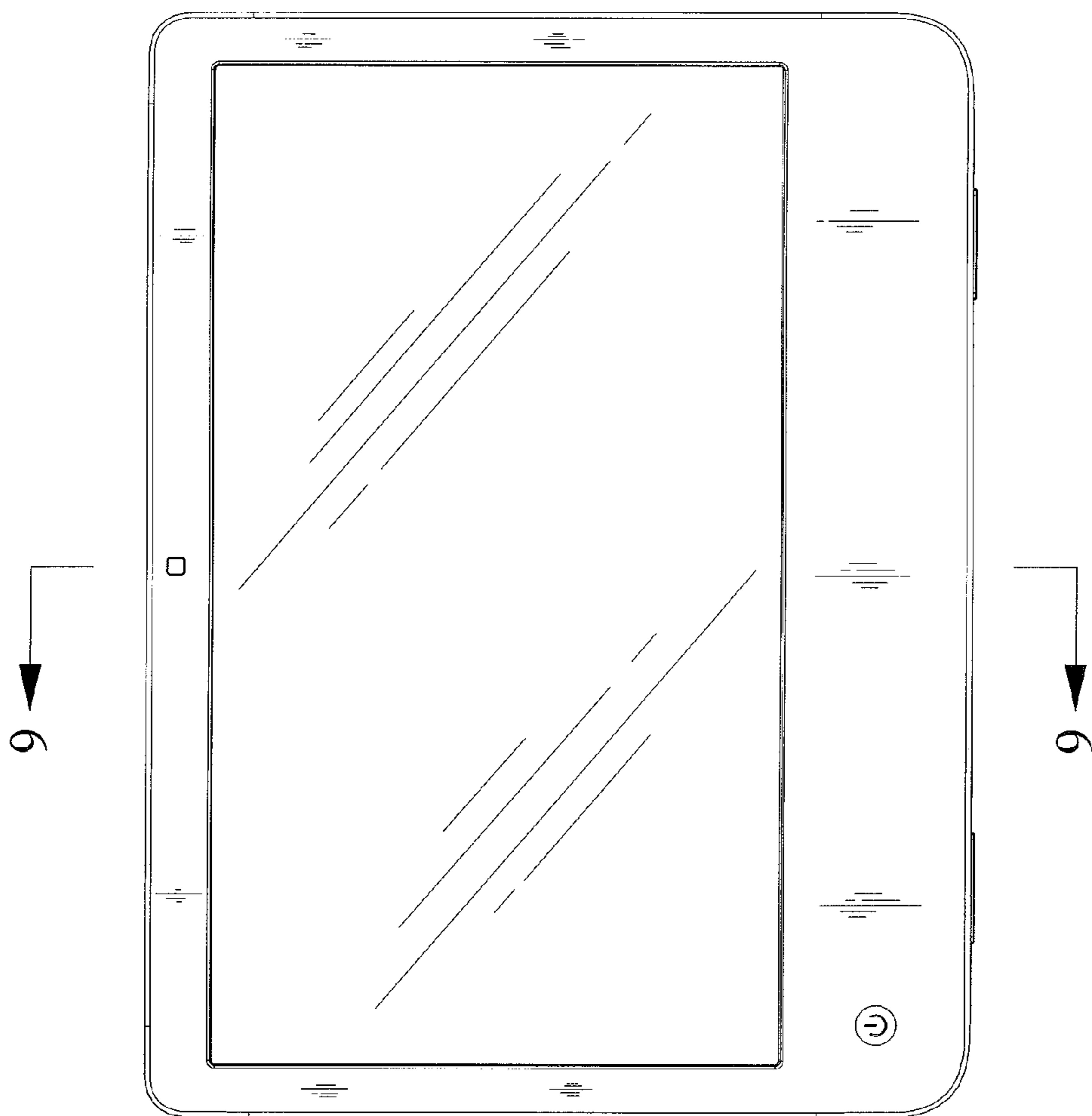

FIG. 2

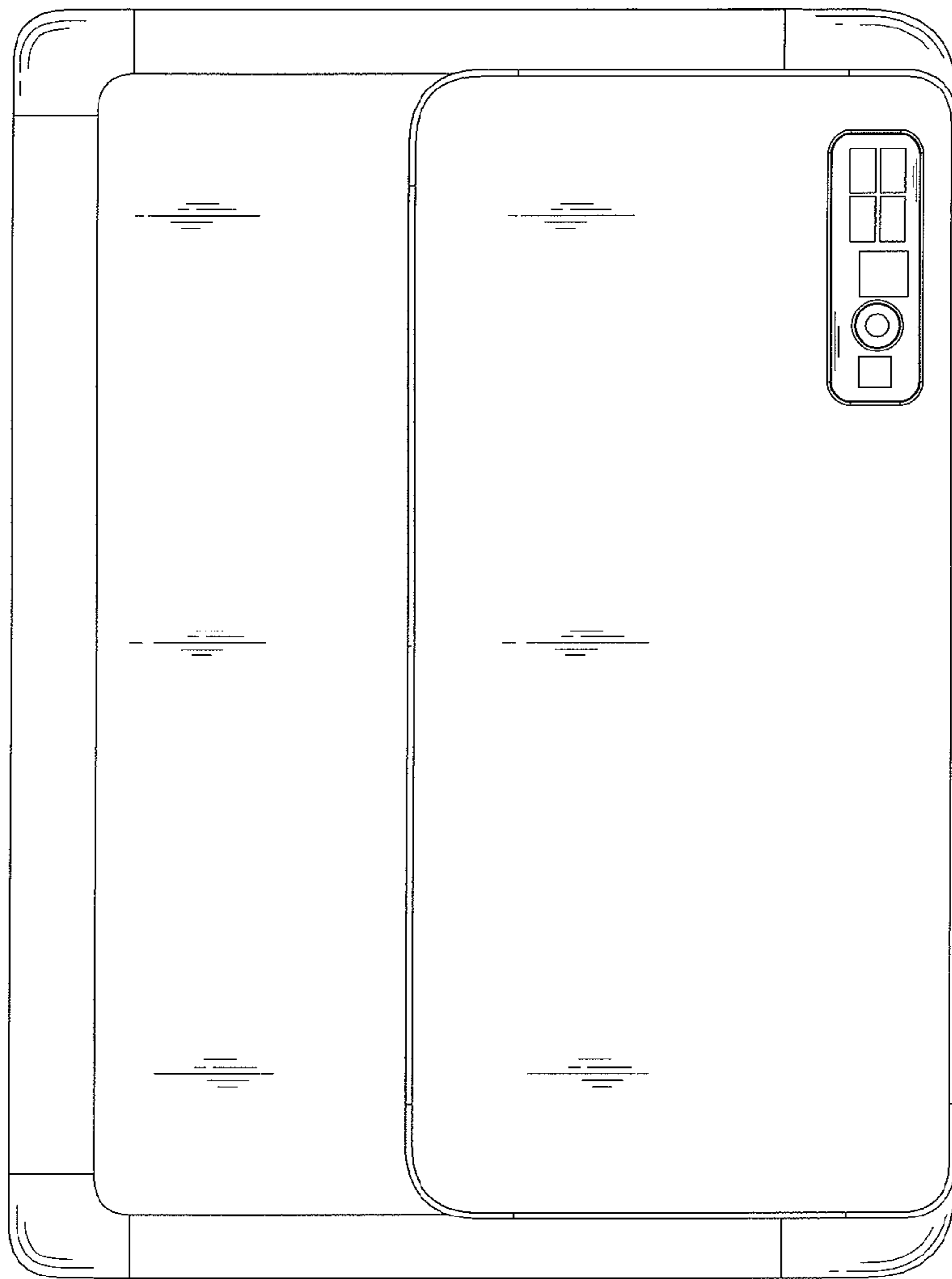

FIG. 3

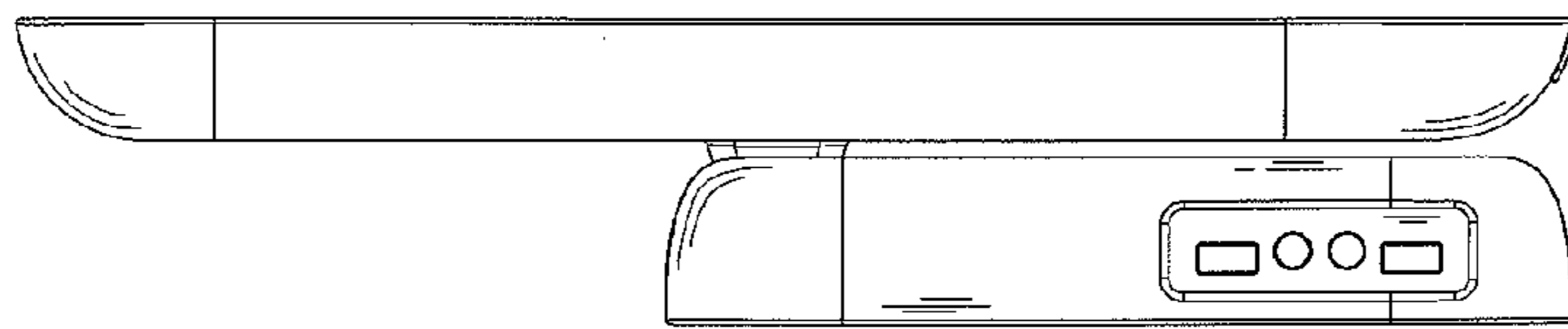

FIG. 4

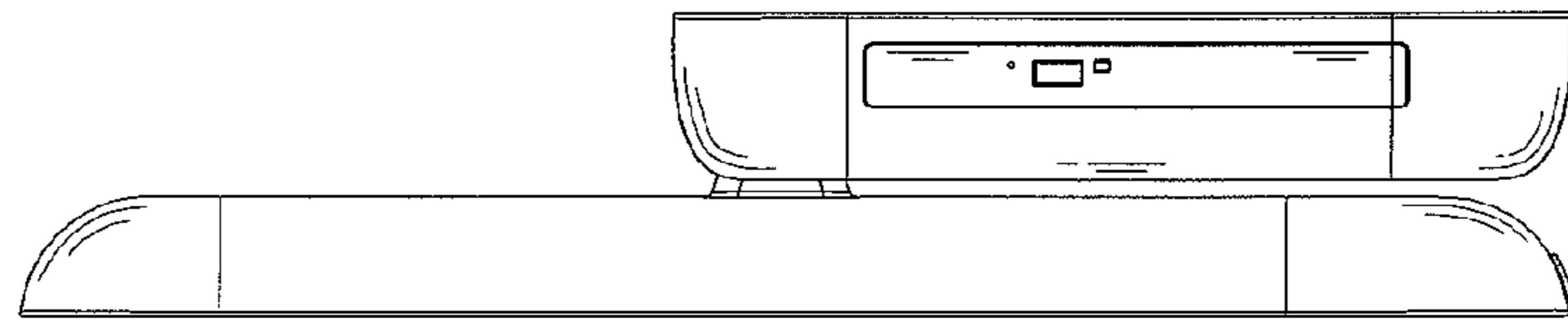

FIG. 5

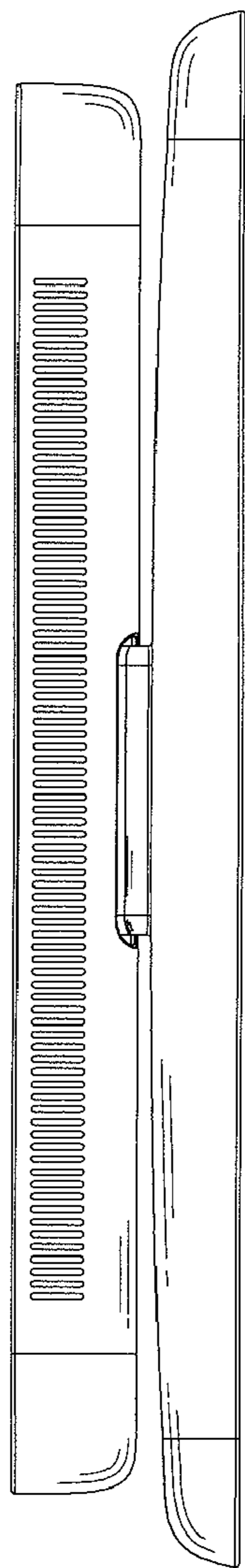

FIG. 6

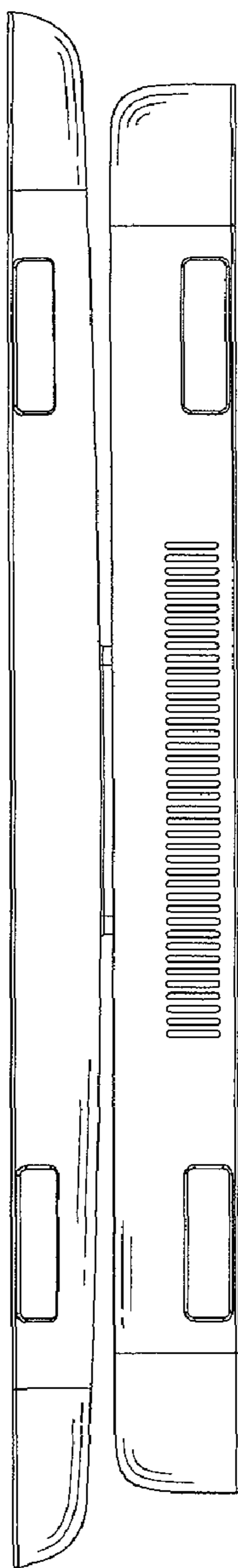

FIG. 7



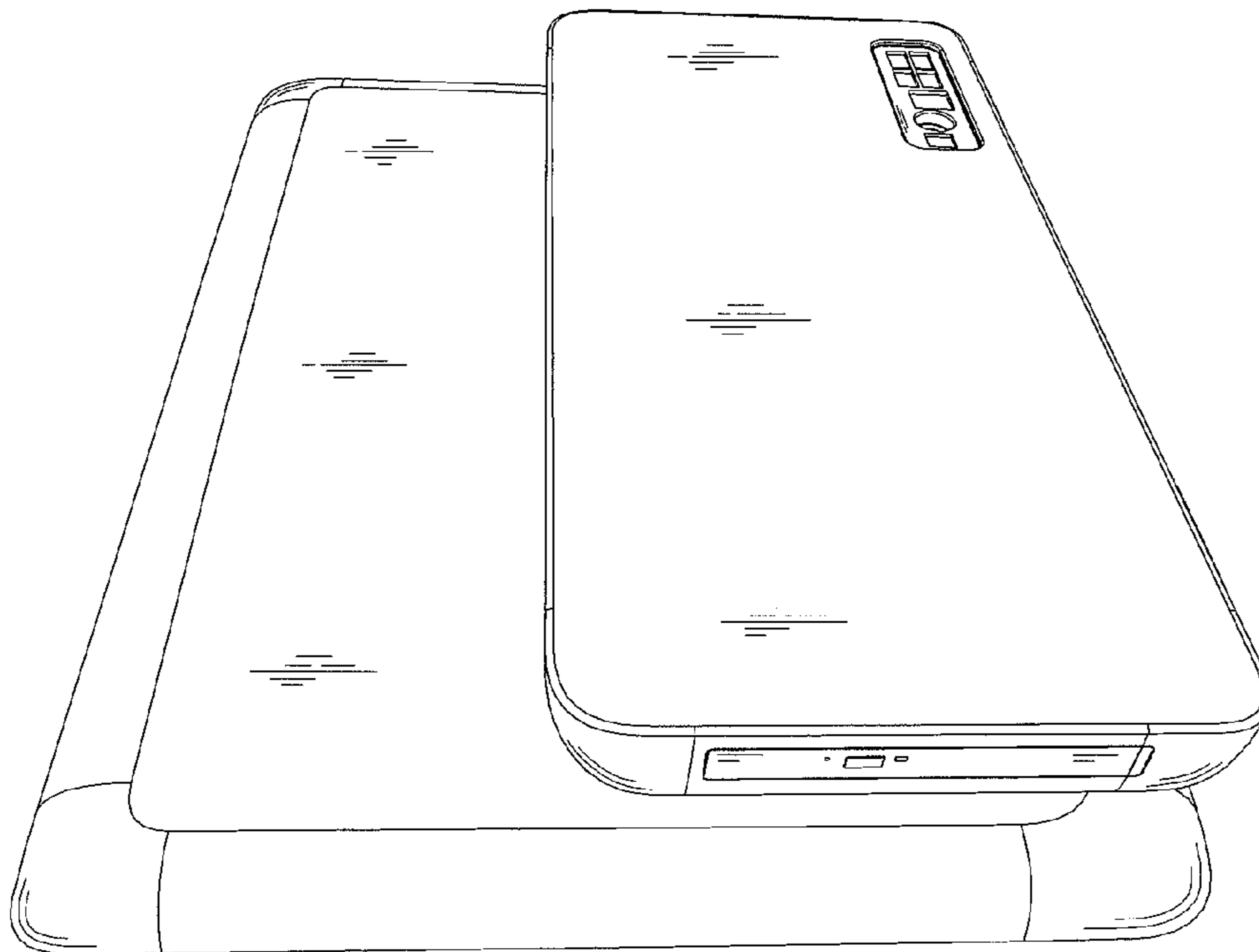

FIG. 8

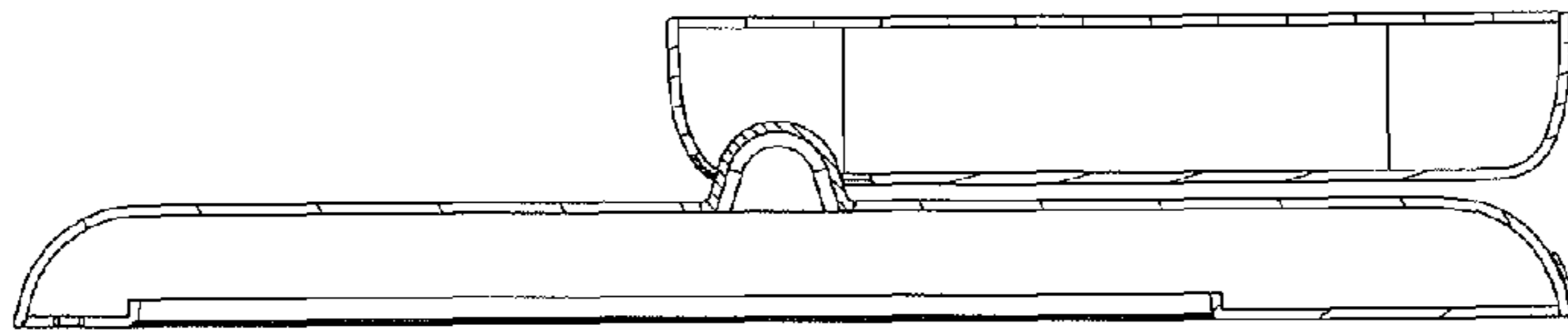

FIG. 9

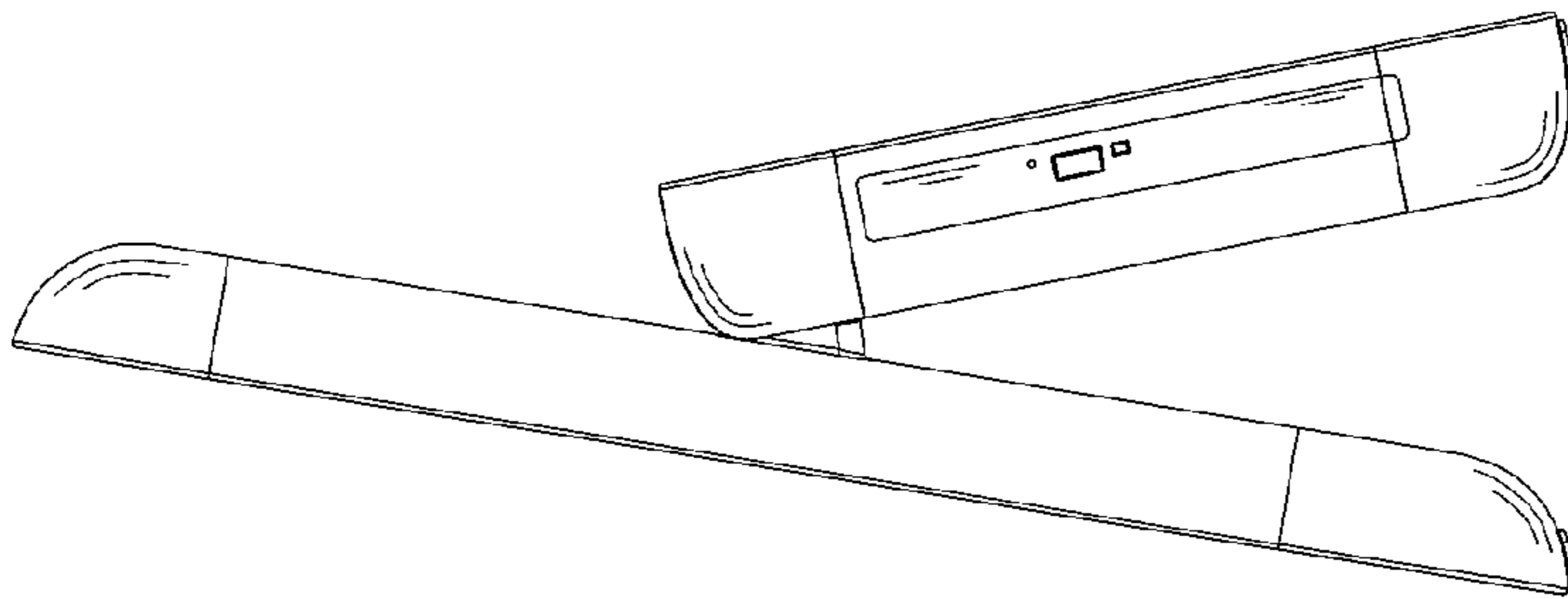

FIG. 10