



US00D626946S

(12) **United States Design Patent**
Lee et al.

(10) **Patent No.:** **US D626,946 S**
(45) **Date of Patent:** **** Nov. 9, 2010**

(54) **WIRELESS HEADSET**

(75) Inventors: **Si-Youn Lee**, Goonpo-si (KR);
Chang-Hwan Hwang, Seongnam-si
(KR); **Gum-Sool Kim**, Anyang-si (KR)

(73) Assignee: **Samsung Electronics Co., Ltd.** (KR)

(**) Term: **14 Years**

(21) Appl. No.: **29/352,252**

(22) Filed: **Dec. 18, 2009**

(30) **Foreign Application Priority Data**

Nov. 6, 2009 (KR) 30-2009-0048845

(51) **LOC (9) Cl.** **14-01**

(52) **U.S. Cl.** **D14/223**

(58) **Field of Classification Search** D14/205,
D14/206, 223, 142, 149, 214, 137, 188; 181/129,
181/130, 135; 379/430, 431, 420.01; 381/380,
381/381; 455/90.1, 90.3, 569.1, 575.2, 575.8;
D24/174

See application file for complete search history.

(56) **References Cited**

U.S. PATENT DOCUMENTS

| | | | | |
|--------------|---------|--------------|-------|---------|
| D334,386 S * | 3/1993 | Yamazaki | | D14/210 |
| D358,394 S * | 5/1995 | Dyas | | D14/214 |
| D389,139 S * | 1/1998 | Oross et al. | | D14/137 |
| D490,070 S * | 5/2004 | Lee | | D14/188 |
| D502,171 S * | 2/2005 | Tang et al. | | D14/223 |
| D518,477 S * | 4/2006 | Chen | | D14/223 |
| D529,483 S * | 10/2006 | Kim et al. | | D14/223 |
| D537,812 S * | 3/2007 | Erich et al. | | D14/206 |

| | | | | |
|----------------|---------|--------------------|-------|-----------|
| D538,271 S * | 3/2007 | Kim et al. | | D14/223 |
| 7,206,618 B2 * | 4/2007 | Latto et al. | | 455/575.8 |
| D552,596 S * | 10/2007 | Christopher | | D14/205 |
| D554,626 S * | 11/2007 | Christopher | | D14/223 |
| D566,103 S * | 4/2008 | Sade et al. | | D14/223 |
| D569,289 S * | 5/2008 | Bender | | D10/104 |
| D575,277 S * | 8/2008 | Gaarde et al. | | D14/223 |
| D579,006 S * | 10/2008 | Kim et al. | | D14/223 |
| D582,897 S * | 12/2008 | Christopher et al. | | D14/223 |
| D593,546 S * | 6/2009 | Tkachuk | | D14/223 |
| D595,272 S * | 6/2009 | Kim et al. | | D14/223 |
| D602,005 S * | 10/2009 | Lee et al. | | D14/223 |
| D602,006 S * | 10/2009 | Kim et al. | | D14/223 |
| D602,007 S * | 10/2009 | Lee et al. | | D14/223 |
| D618,221 S * | 6/2010 | Fahrendorff et al. | | D14/223 |

* cited by examiner

Primary Examiner—Paula Greene

(74) *Attorney, Agent, or Firm*—NSIP Law

(57) **CLAIM**

The ornamental design for a wireless headset, as shown and described.

DESCRIPTION

FIG. 1 is a perspective view of a wireless headset;
FIG. 2 is a front view of the wireless headset of FIG. 1;
FIG. 3 is a rear view of the wireless headset of FIG. 1;
FIG. 4 is a left-side view of the wireless headset of FIG. 1;
FIG. 5 is a right-side view of the wireless headset of FIG. 1;
FIG. 6 is a top plan view of the wireless headset of FIG. 1; and,
FIG. 7 is a bottom plan view of the wireless headset of FIG. 1.

1 Claim, 6 Drawing Sheets

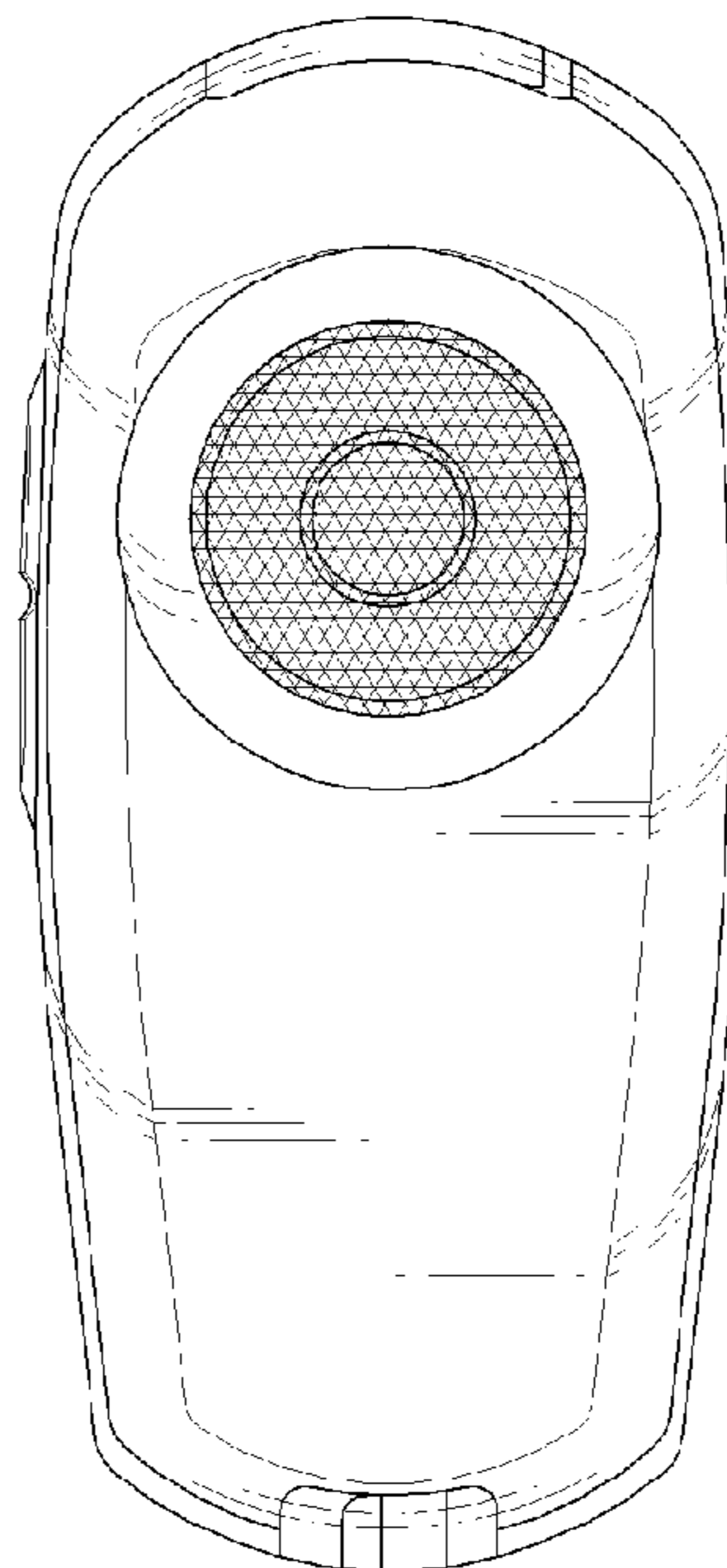
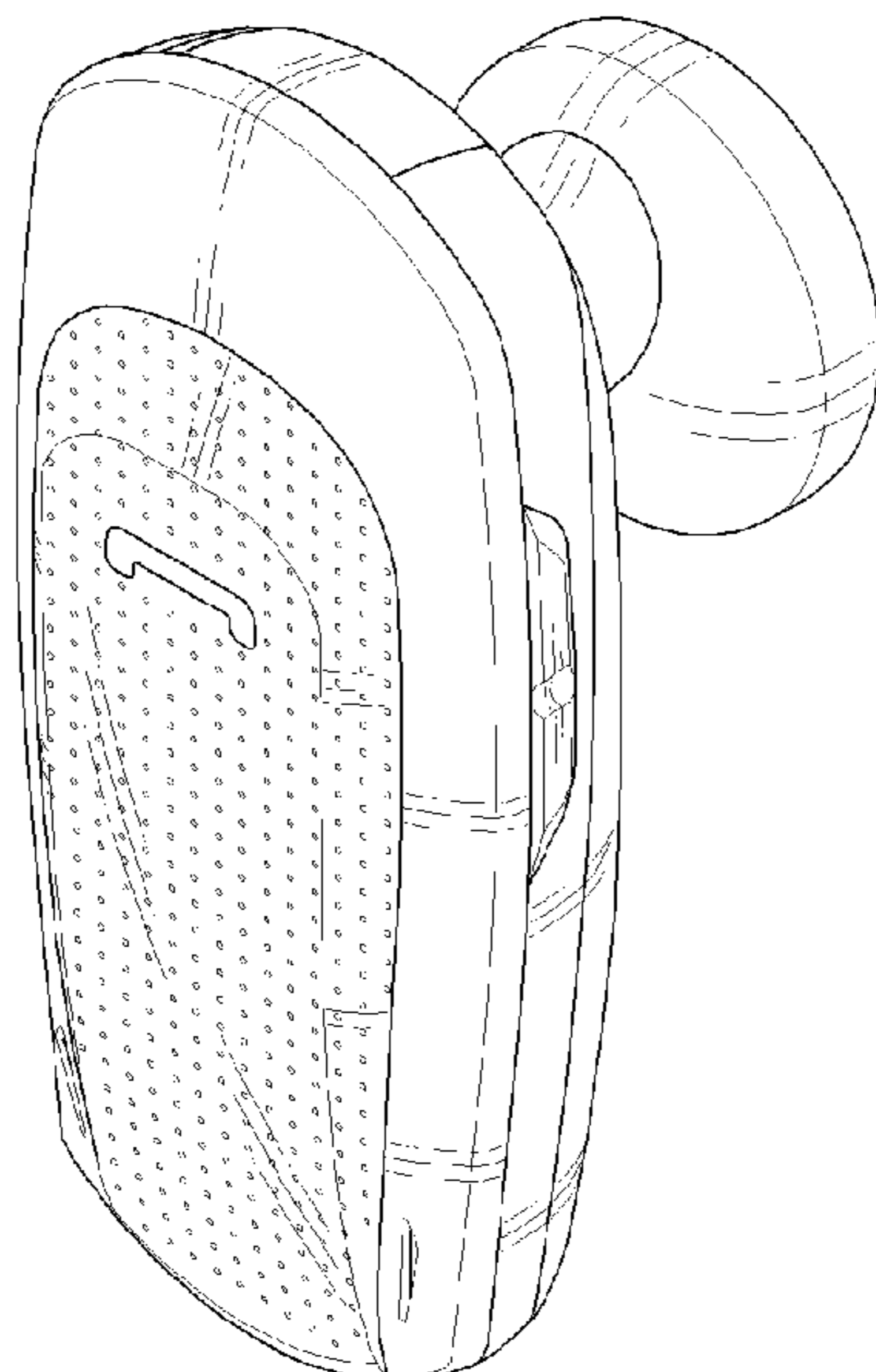

FIG. 1

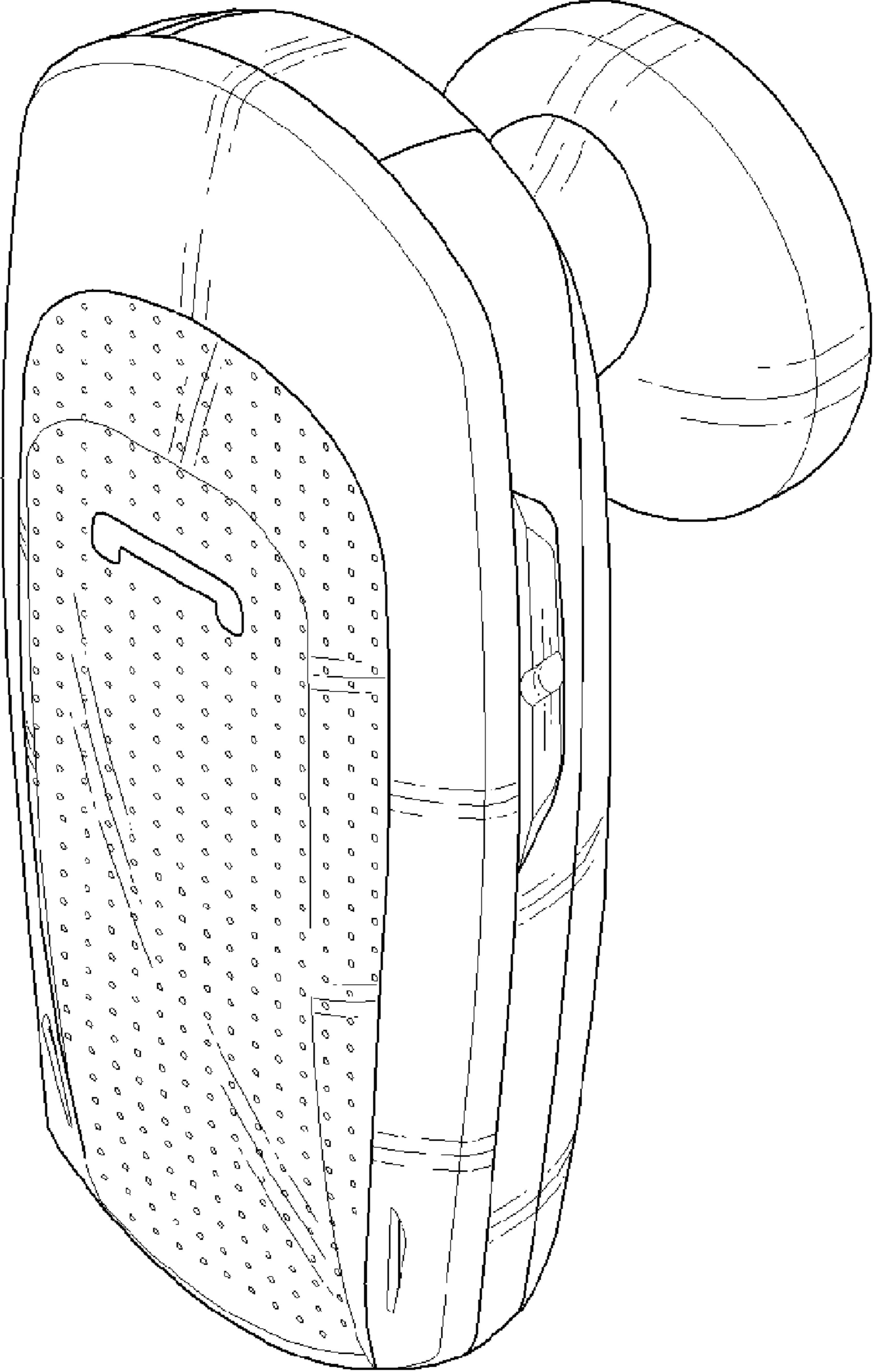

FIG. 2

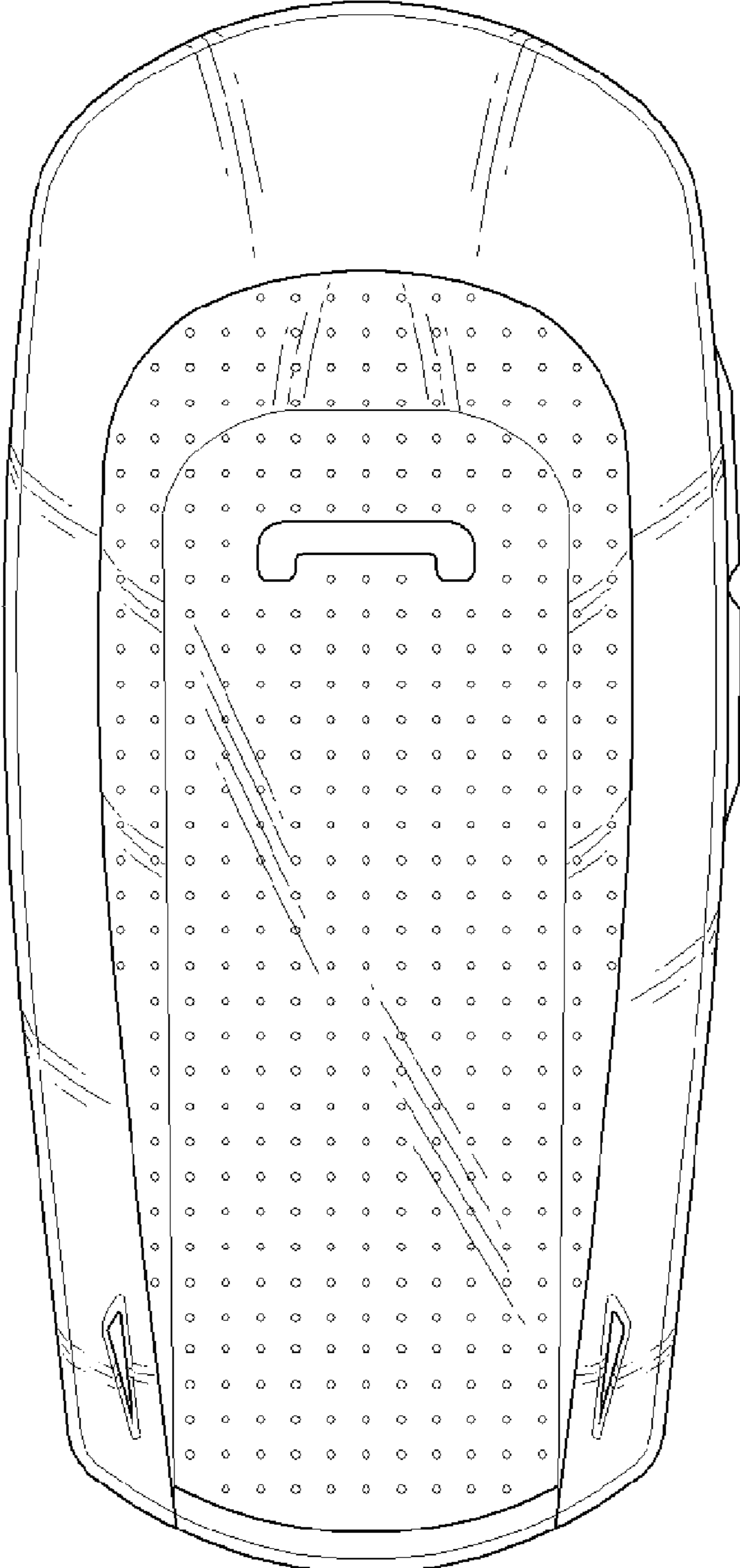

FIG. 3

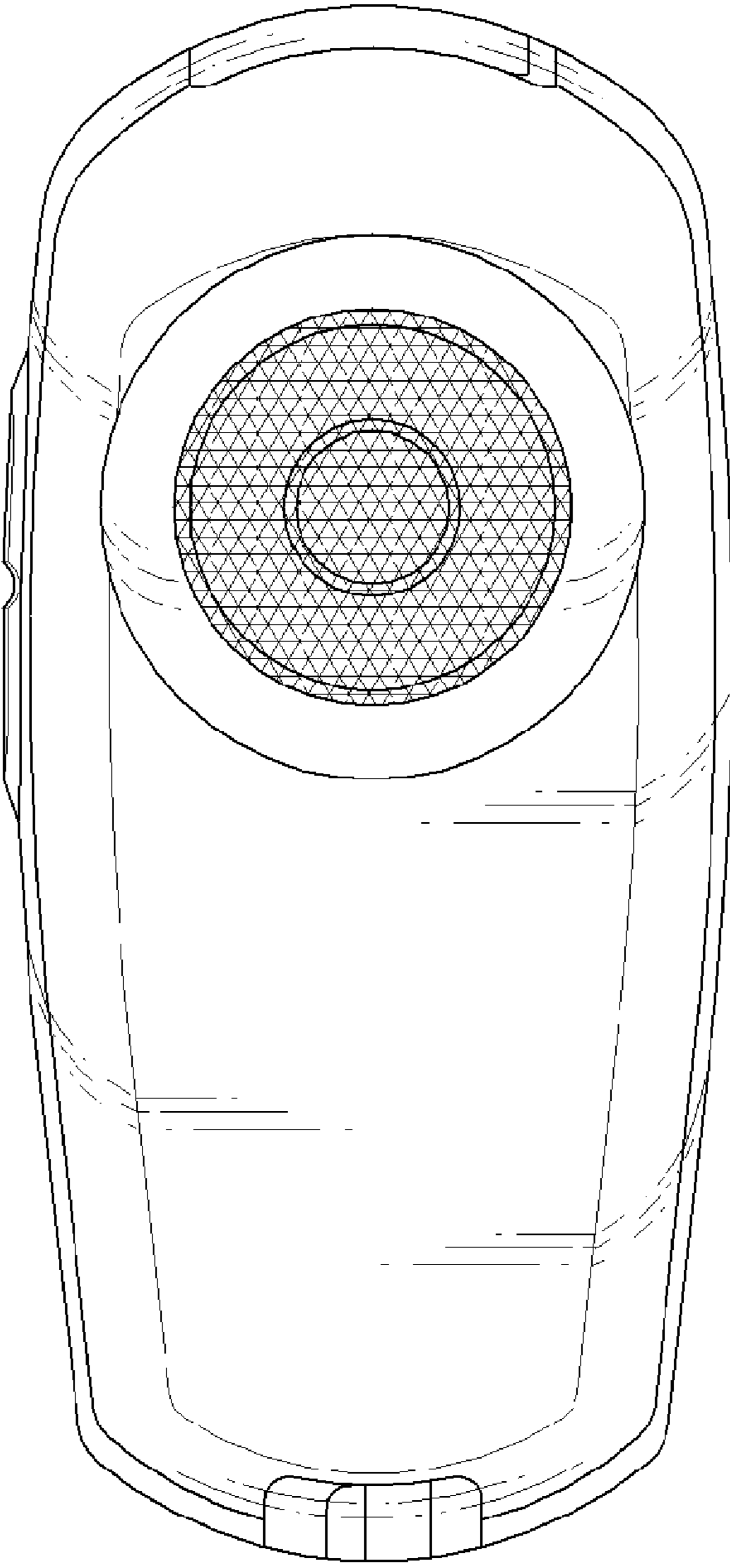

FIG. 4

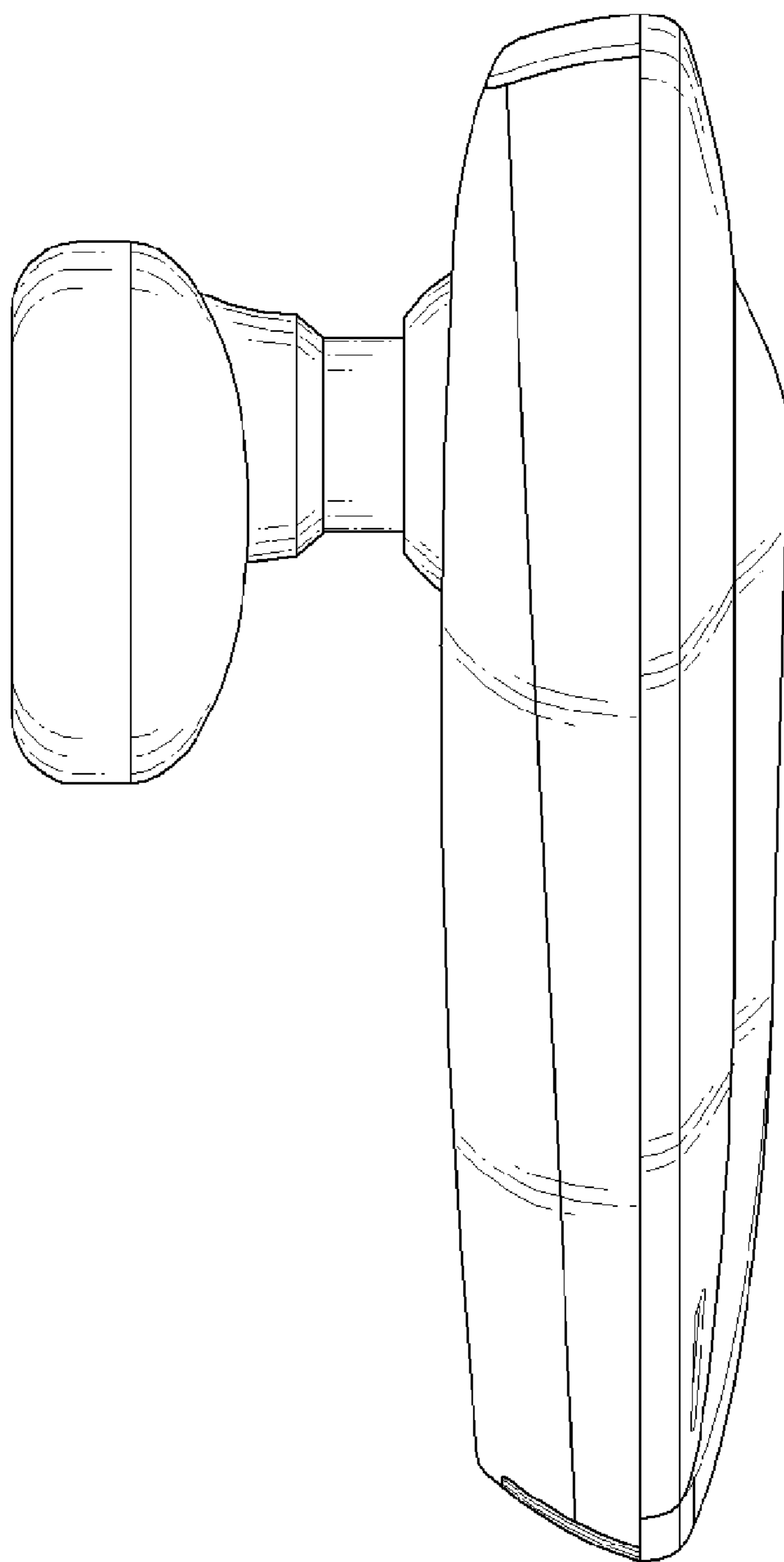

FIG. 5

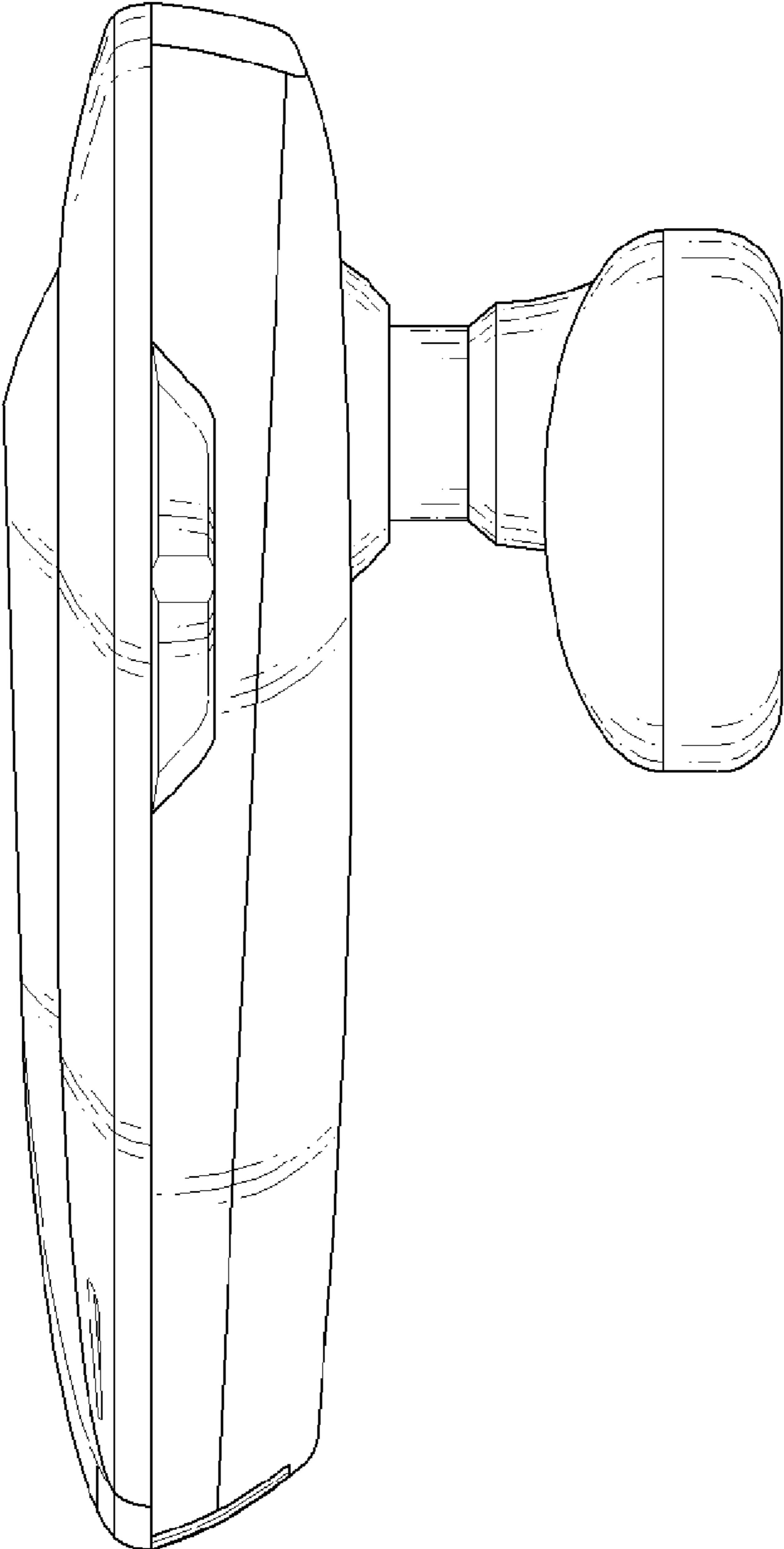

FIG. 6

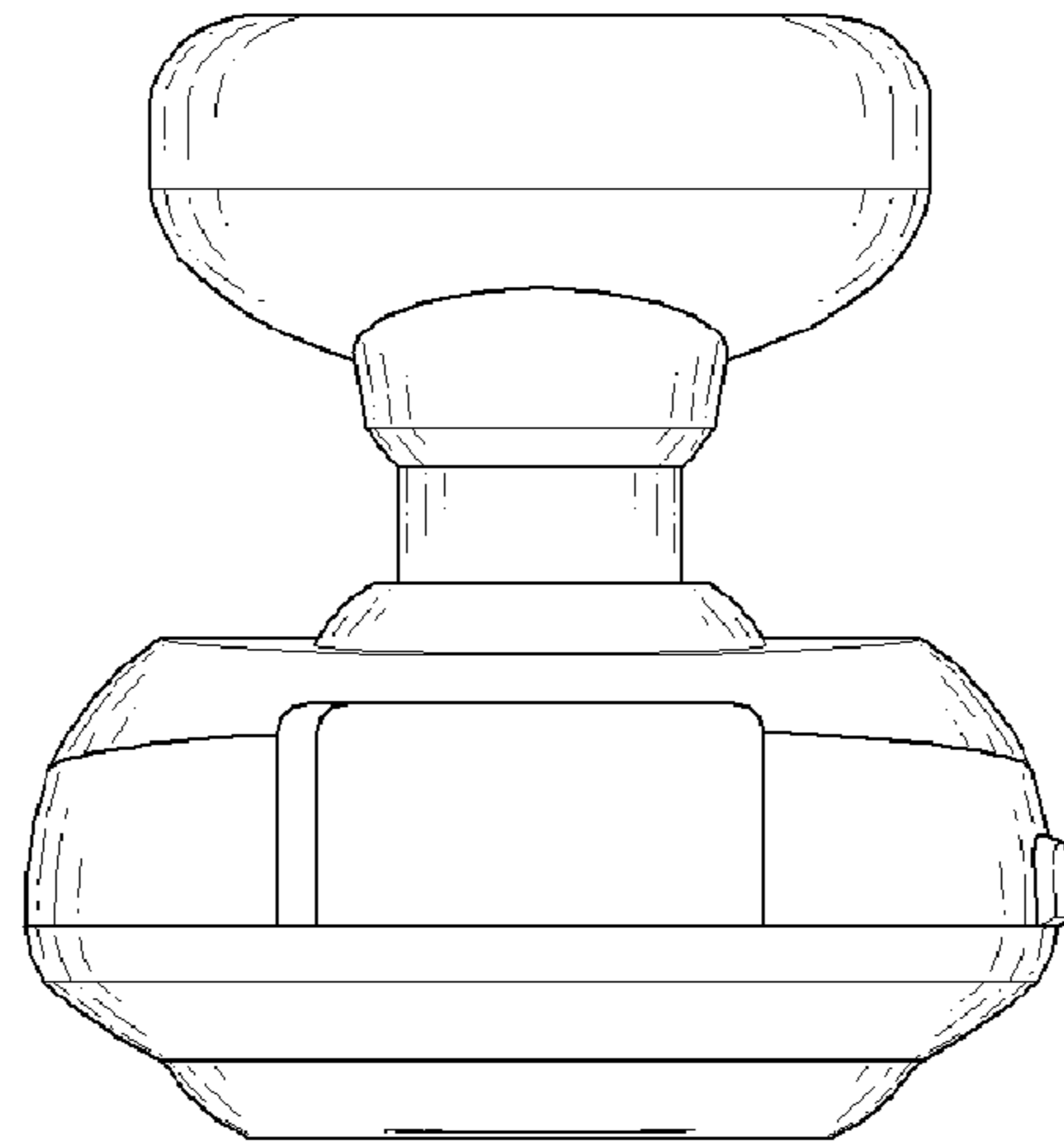

FIG. 7

