



US00D626934S

(12) **United States Design Patent**
Lee et al.

(10) **Patent No.:** **US D626,934 S**
(45) **Date of Patent:** **** Nov. 9, 2010**

(54) **CELLULAR PHONE**

(75) Inventors: **Hye-Jeong Lee**, Seoul (KR); **Beom-Ku Han**, Seoul (KR); **Jung-Hyeok Im**, Seongnam (KR); **Min-Ah Koh**, Seoul (KR); **Ji-Hye Youn**, Seongnam-si (KR); **Chang-Hwan Hwang**, Seongnam-si (KR)

(73) Assignee: **Samsung Electronics Co., Ltd.**, Maetan-dong, Yeontong-gu, Suwon-si, Gyeonggi-do (KR)

(**) Term: **14 Years**

(21) Appl. No.: **29/356,820**

(22) Filed: **Mar. 3, 2010**

(51) **LOC (9) Cl.** **14-03**

(52) **U.S. Cl.** **D14/138 AA**

(58) **Field of Classification Search** D14/138 AA,
D14/496, 341, 345, 346, 203.3, 203.4, 203.7,
D14/138 AD, 138 R; 455/575.1, 556.2;
D21/517; 379/433.01, 433.04

See application file for complete search history.

(56) **References Cited**

U.S. PATENT DOCUMENTS

D543,184 S *	5/2007	Moon et al.	D14/138 AA
D555,626 S *	11/2007	Son et al.	D14/138 AA
D559,224 S *	1/2008	Moon et al.	D14/138 AA
D560,646 S *	1/2008	Yun et al.	D14/138 AA
D569,823 S *	5/2008	Lyles et al.	D14/138 AA
D573,570 S *	7/2008	Park et al.	D14/138 AA
D573,967 S *	7/2008	Tsai et al.	D14/138 AA
D579,909 S *	11/2008	Huang et al.	D14/138 AA
D583,350 S *	12/2008	Park et al.	D14/138 AA
D583,352 S *	12/2008	Son et al.	D14/138 AA
D591,253 S *	4/2009	Liu	D14/138 AA
D594,834 S *	6/2009	Su et al.	D14/138 AA
D598,413 S *	8/2009	Chen	D14/138 AA
D602,459 S *	10/2009	Cai	D14/138 AA
D606,956 S *	12/2009	Wang et al.	D14/138 AA
D609,673 S *	2/2010	Du	D14/138 AA

D610,116 S *	2/2010	He	D14/138 AA
D615,060 S *	5/2010	Kim et al.	D14/138 AA
D615,941 S *	5/2010	He	D14/138 AA
D615,944 S *	5/2010	Jeong et al.	D14/138 AA
D617,765 S *	6/2010	Liu	D14/138 AA
D620,911 S *	8/2010	Kim et al.	D14/138 AA
D622,246 S *	8/2010	Lee et al.	D14/138 AD

OTHER PUBLICATIONS

Samsung C3200 monte Bar telephone, announced Jun. 2006, [online], [site visited Aug. 17, 2010]. Available from Internet, <URL: <http://www.gsmarena.com>>.*

Samsung E200 ECO telephone, announced Aug. 2008, [online], [site visited Aug. 17, 2010]. Available from Internet, <URL: <http://www.gsmarena.com>>.*

Nokia 1650 telephone, announced May 2007, [online], [site visited Aug. 17, 2010]. Available from Internet, <URL: <http://www.gsmarena.com>>.*

(Continued)

Primary Examiner—Jeffrey D Asch

(74) *Attorney, Agent, or Firm*—Lexyoume IP Group, PLLC.

(57) **CLAIM**

The ornamental design for a cellular phone, as shown and described.

DESCRIPTION

FIG. 1 is a perspective view of a cellular phone showing our new design;

FIG. 2 is a front elevational view thereof;

FIG. 3 is a rear elevational view thereof;

FIG. 4 is a left side elevational view thereof;

FIG. 5 is a right side elevational view thereof;

FIG. 6 is a top plan view thereof; and,

FIG. 7 is a bottom plan view thereof.

1 Claim, 7 Drawing Sheets

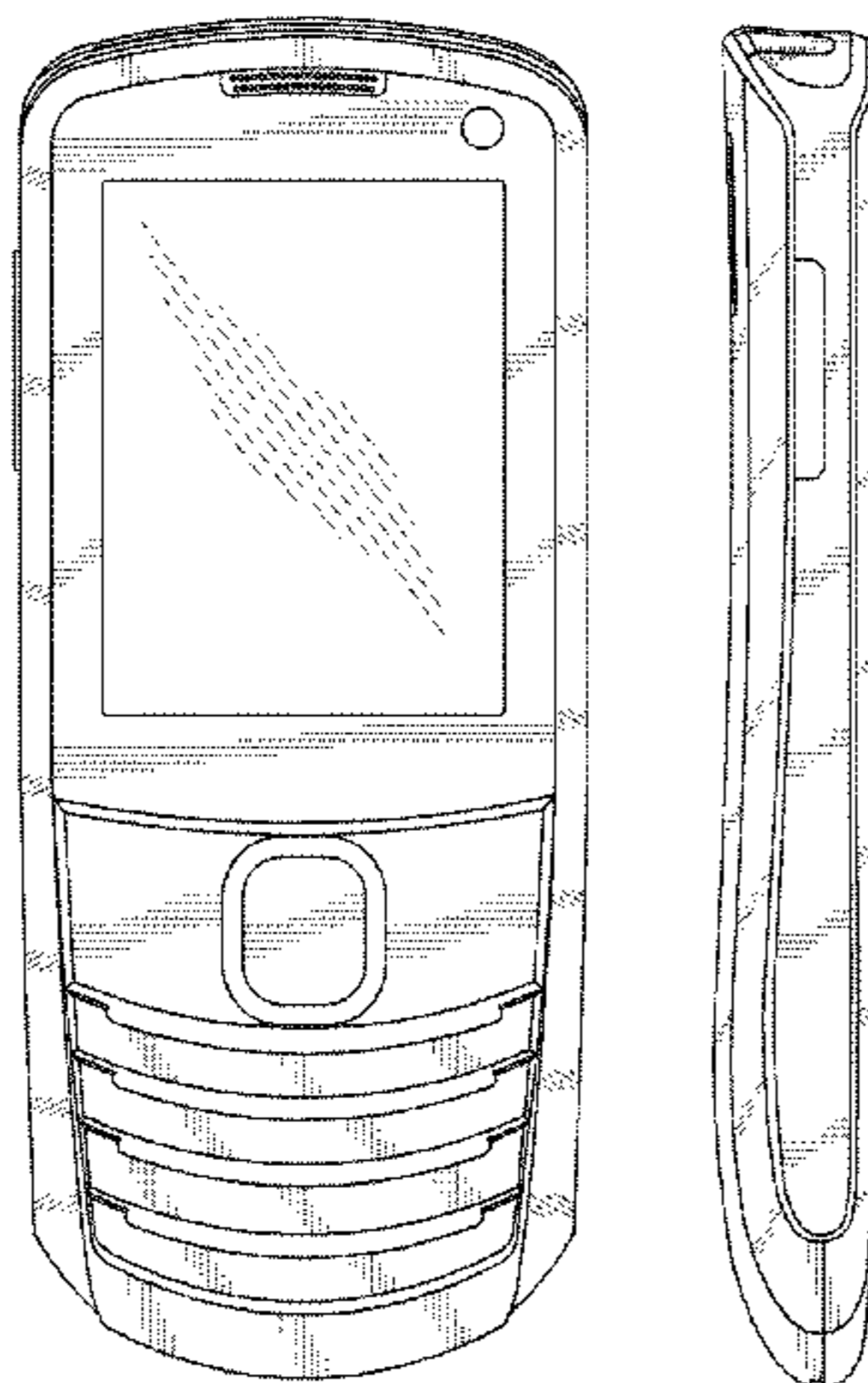

OTHER PUBLICATIONS

Samsung Impact b telephone, announced Jun. 2008, [online], [site visited Aug. 17, 2010]. Available from Internet, <URL: <http://www.gsmarena.com>>.*

LG GB190 telephone, announced Oct. 2009, [online], [site visited Aug. 17, 2010]. Available from Internet, <URL: <http://www.gsmarena.com>>.*

LG GS155 telephone, announced Mar. 2010, [online], [site visited Aug. 17, 2010]. Available from Internet, <URL: <http://www.gsmarena.com>>.*

Haier M300 telephone, announced 2010, [online], [site visited Aug. 17, 2010]. Available from Internet, <URL: <http://www.gsmarena.com>>.*

Sagem MY X6-2 telephone, announced 1st quarter 2005, [online], [site visited Aug. 17, 2010]. Available from Internet, <URL: <http://www.gsmarena.com>>.*

* cited by examiner

FIG. 1

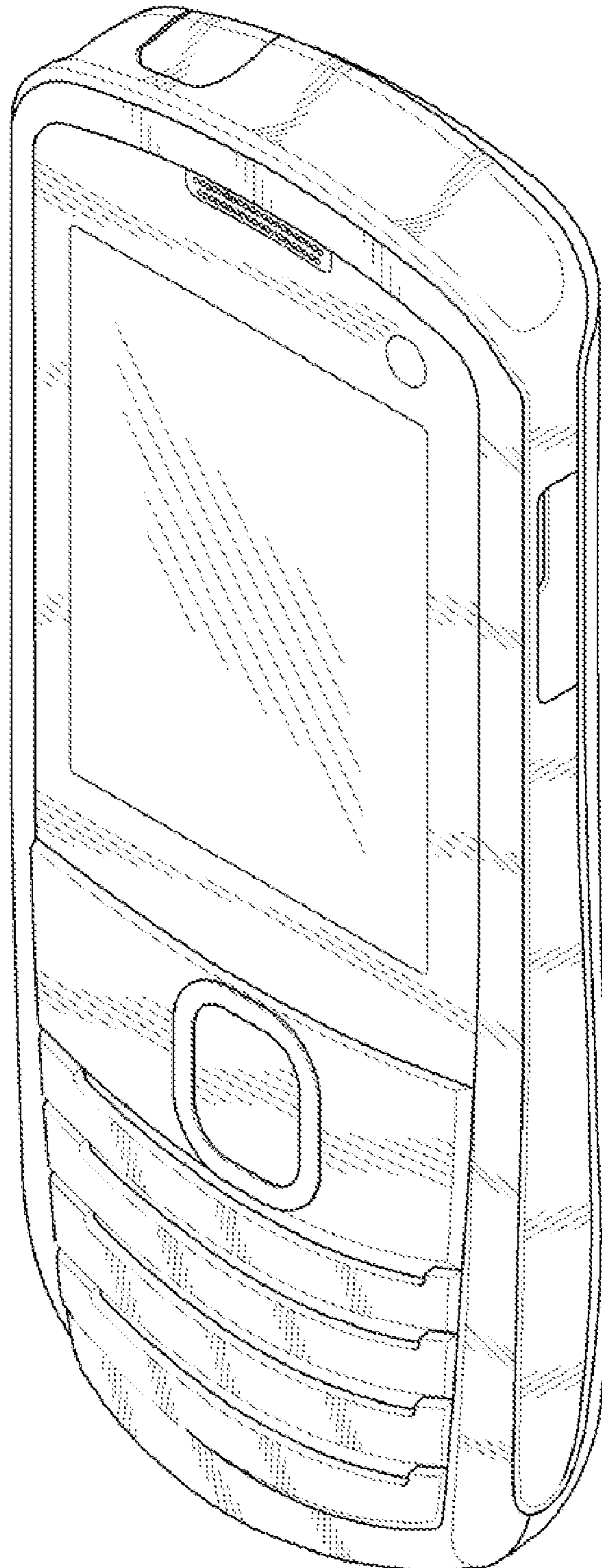

FIG. 2

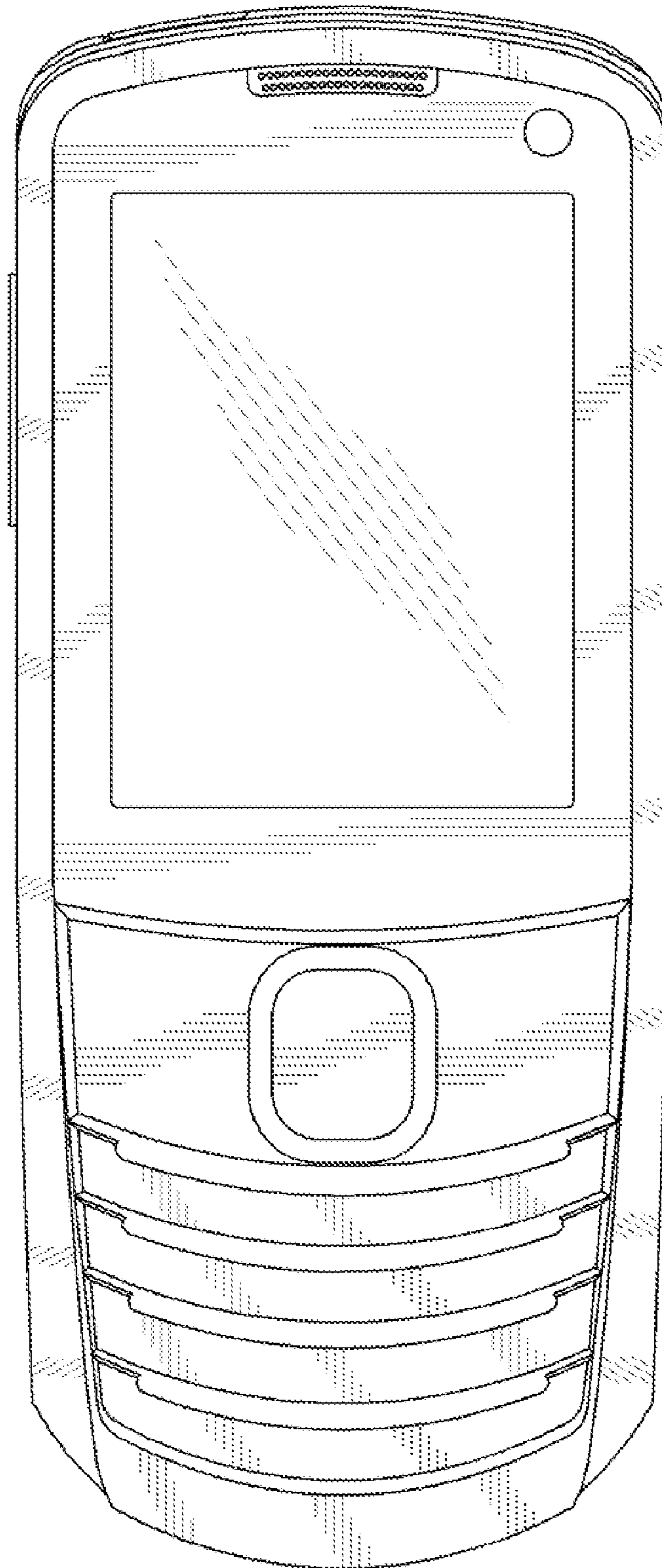

FIG.3

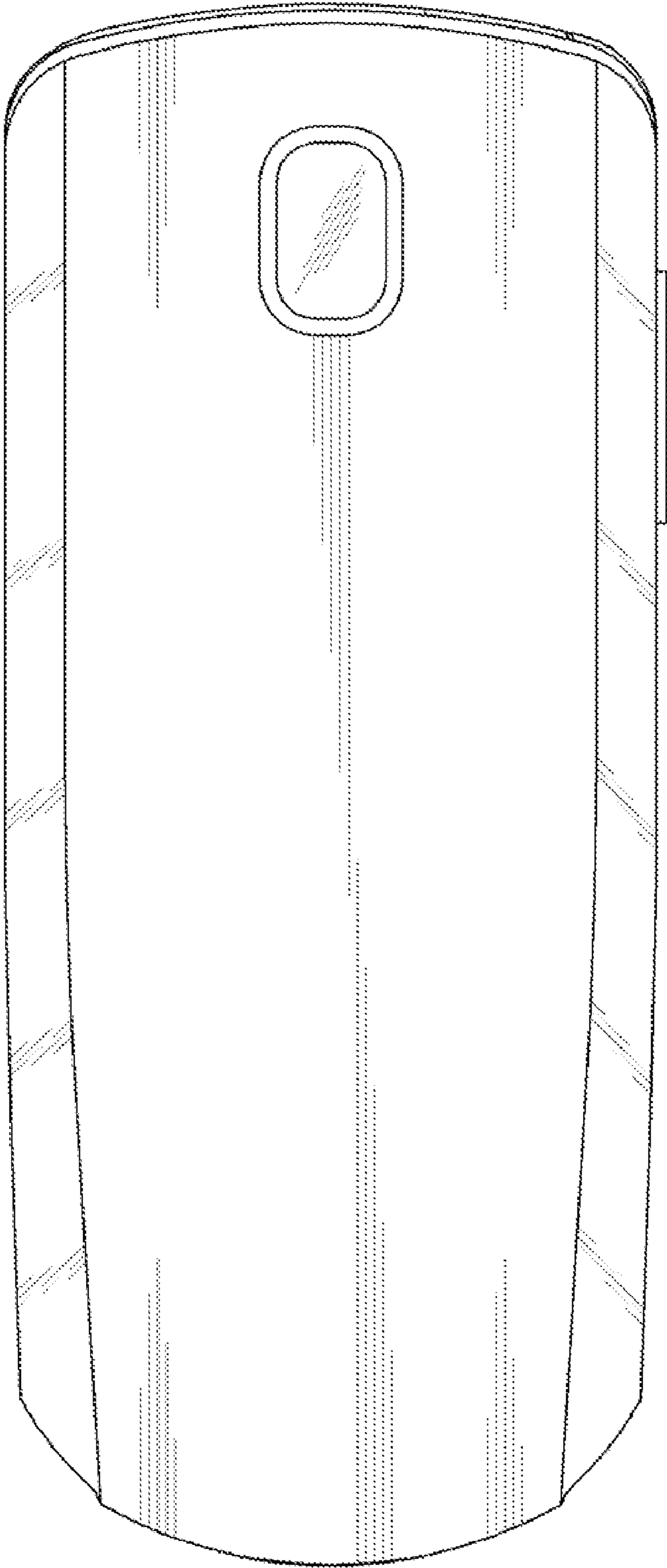

FIG. 4

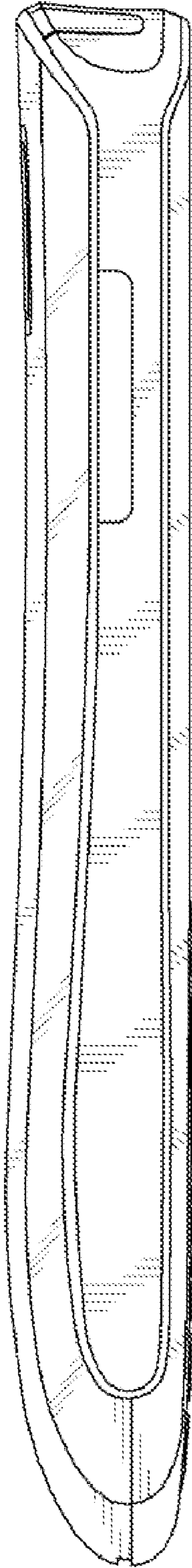

FIG. 5

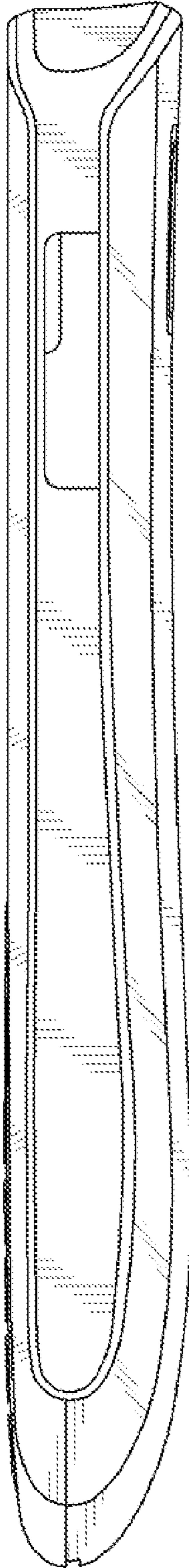

FIG. 6

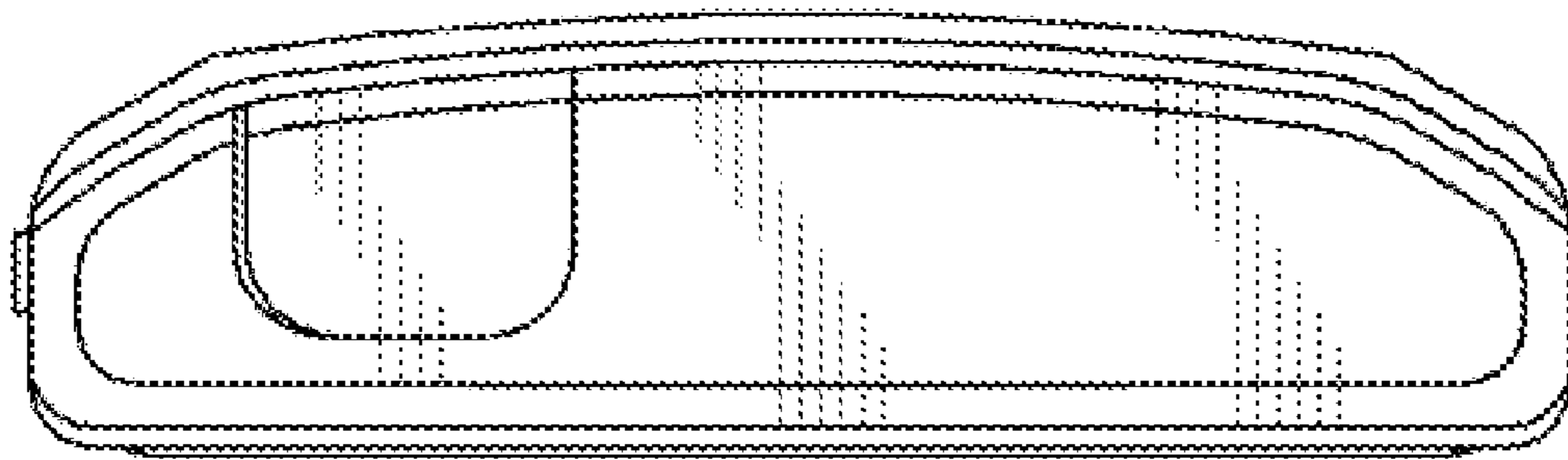

FIG. 7

