



US00D626898S

(12) **United States Design Patent**
Wu

(10) **Patent No.:** **US D626,898 S**

(45) **Date of Patent:** **** Nov. 9, 2010**

(54) **AUTOMOBILE GRILLE**

(75) Inventor: **Hua-Chi Wu**, Tainan (TW)

(73) Assignee: **Coplus Inc.**, Tainan Hsien (TW)

(**) Term: **14 Years**

(21) Appl. No.: **29/359,606**

(22) Filed: **Apr. 13, 2010**

(51) **LOC (9) Cl.** **12-16**

(52) **U.S. Cl.** **D12/163**

(58) **Field of Classification Search** D12/163,
D12/196, 171, 169, 216, 90-92, 86; 180/68.1,
180/68.6; 296/193.11

See application file for complete search history.

(56) **References Cited**

U.S. PATENT DOCUMENTS

D454,096 S *	3/2002	Marchese et al.	D12/163
D480,998 S *	10/2003	DeBerti	D12/187
D494,112 S *	8/2004	Marchese et al.	D12/163
D494,513 S *	8/2004	Ito	D12/163
D497,123 S *	10/2004	Marchese et al.	D12/163
D528,947 S *	9/2006	Carli et al.	D12/126
D532,344 S *	11/2006	Adams et al.	D12/163

D557,641 S *	12/2007	Davidson	D12/163
D560,572 S *	1/2008	Okamoto et al.	D12/163
D563,288 S *	3/2008	Moore	D12/163
D610,052 S *	2/2010	Watanabe	D12/163
D613,210 S *	4/2010	Wu	D12/163
D613,211 S *	4/2010	Wu	D12/163
D613,212 S *	4/2010	Wu	D12/163

* cited by examiner

Primary Examiner—Melody N Brown

(74) *Attorney, Agent, or Firm*—Christie, Parker & Hale, LLP

(57) **CLAIM**

The ornamental design for a automobile grille, as shown and described.

DESCRIPTION

FIG. 1 is a perspective view of a automobile grille;

FIG. 2 is a front end view thereof;

FIG. 3 is a rear end view thereof;

FIG. 4 is a left side view thereof;

FIG. 5 is a right side view thereof;

FIG. 6 is a top view thereof; and,

FIG. 7 is a bottom view thereof.

1 Claim, 6 Drawing Sheets

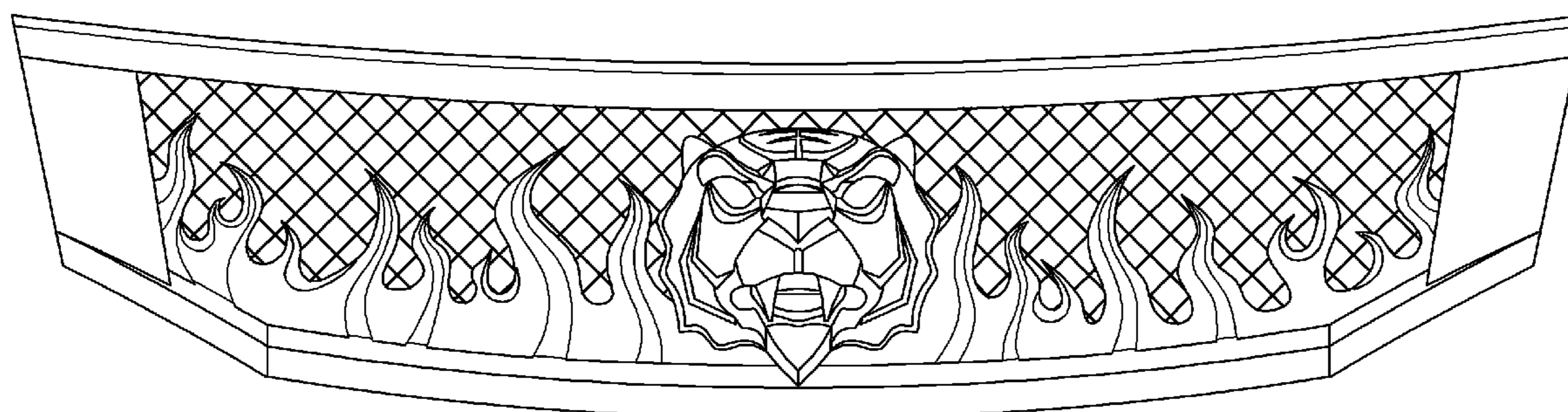

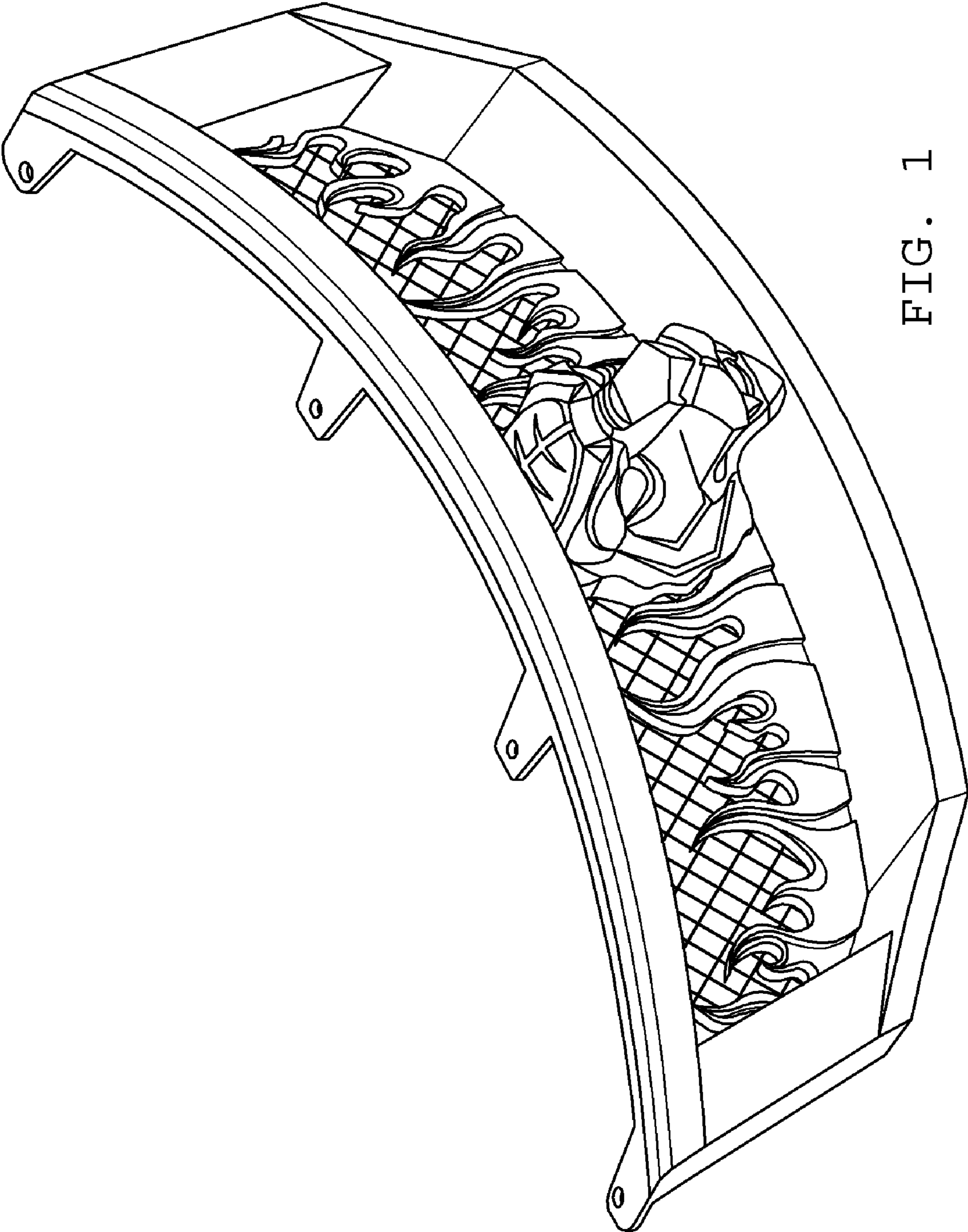

FIG. 1

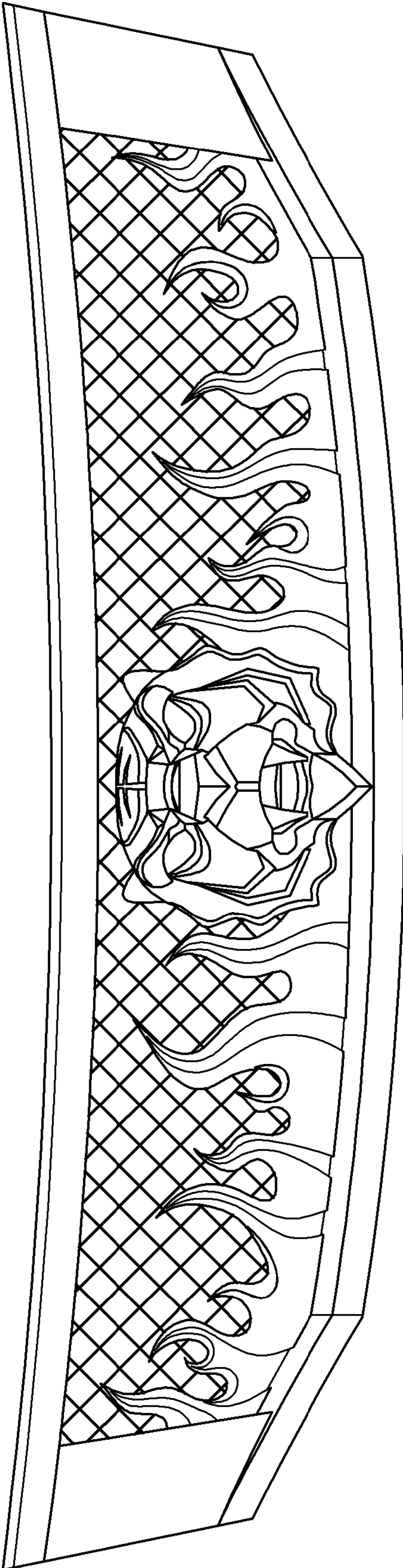

FIG. 2

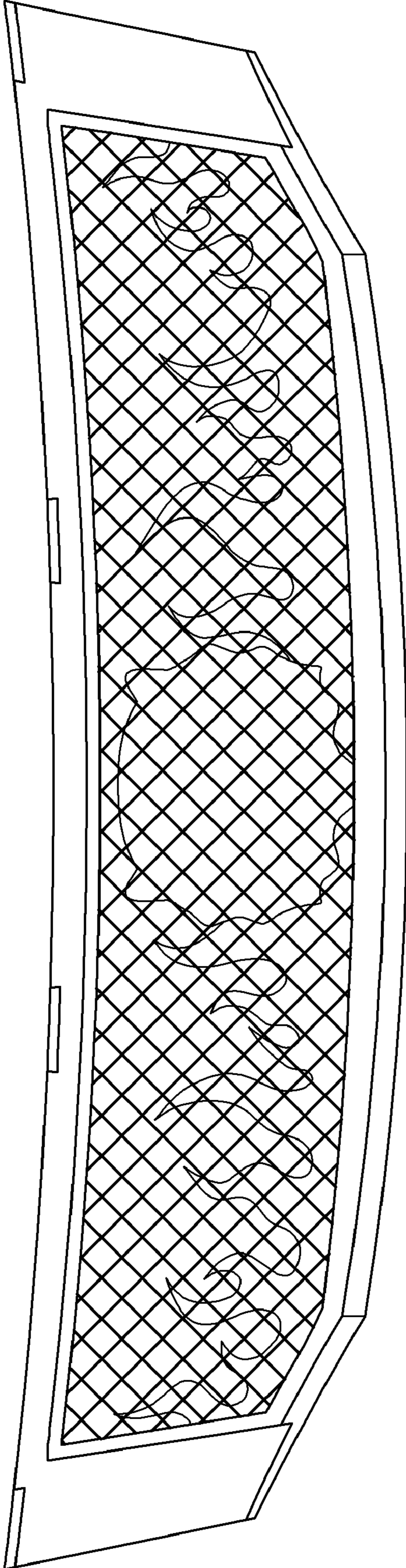

FIG. 3

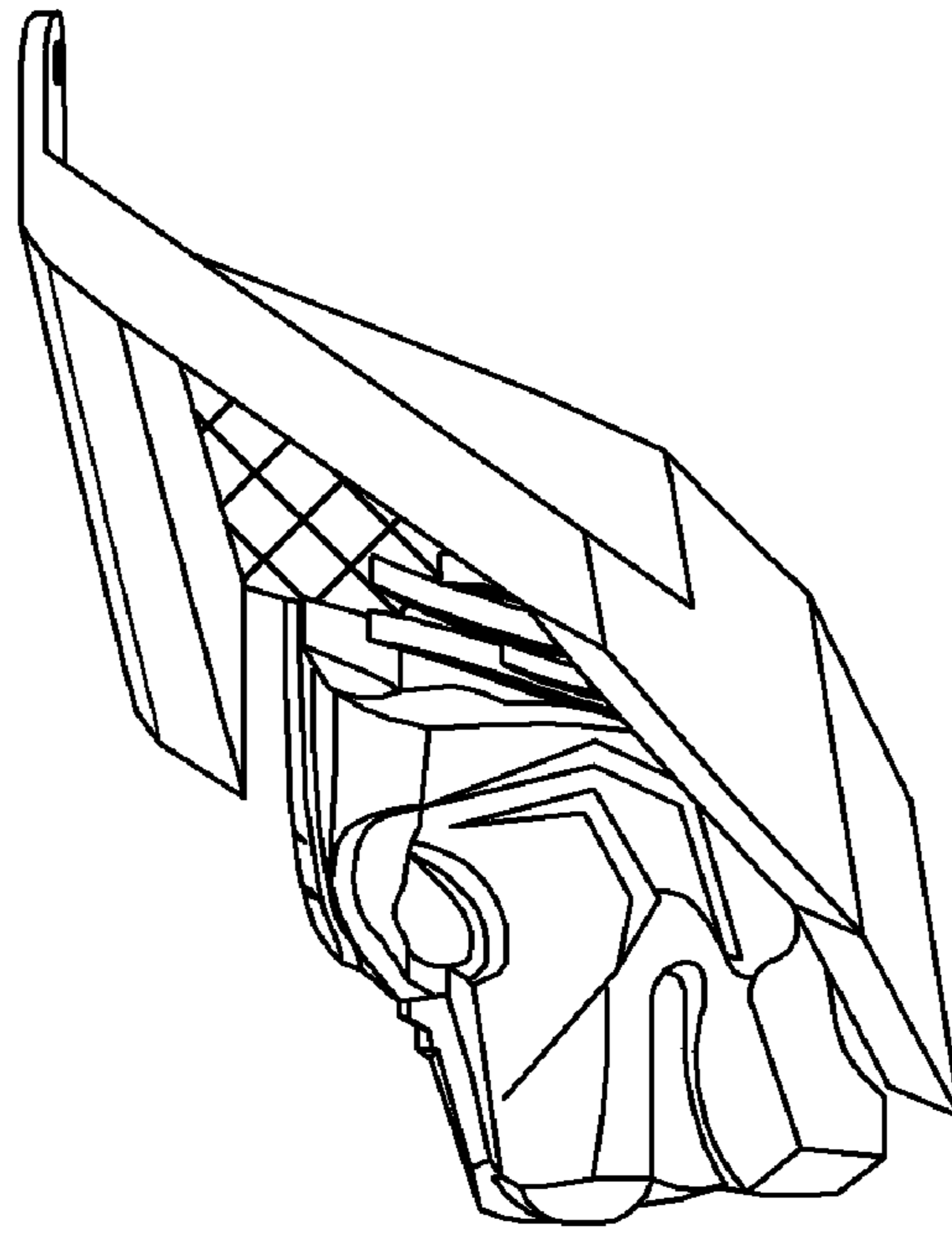

FIG. 5

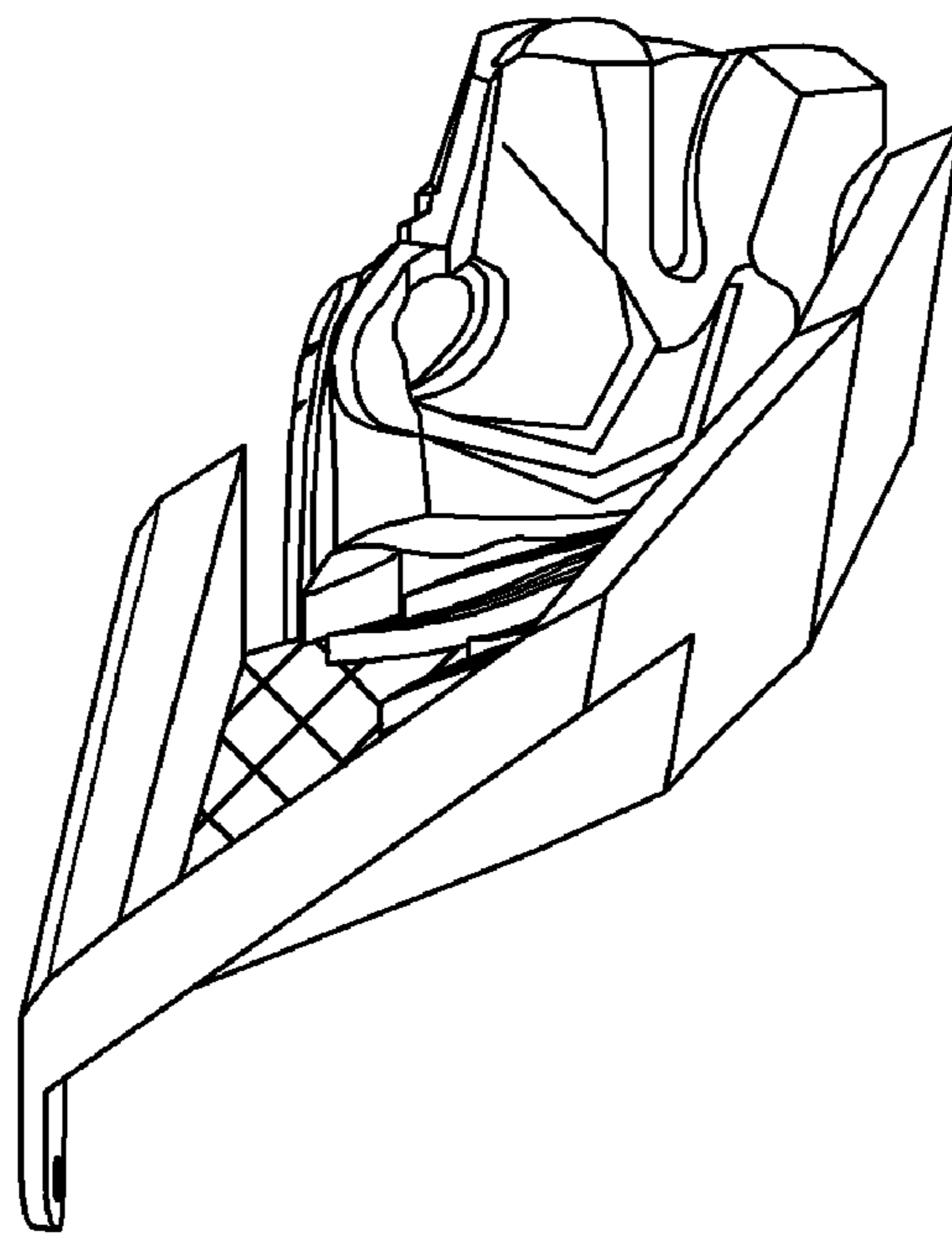

FIG. 4

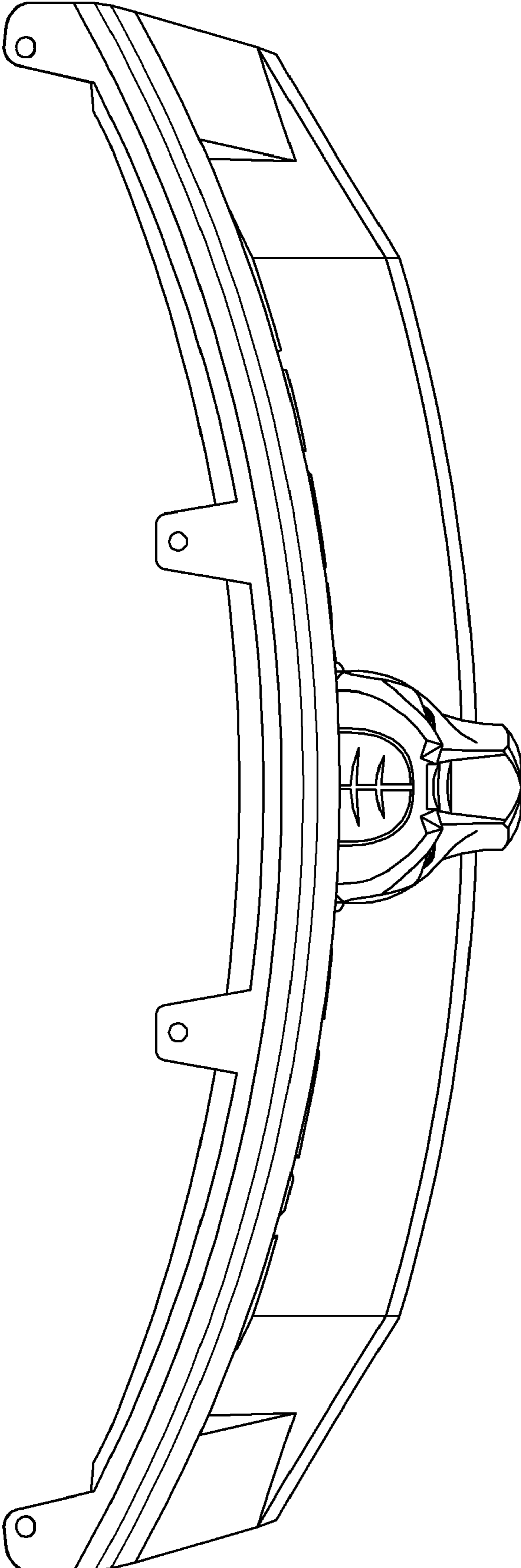

FIG. 6

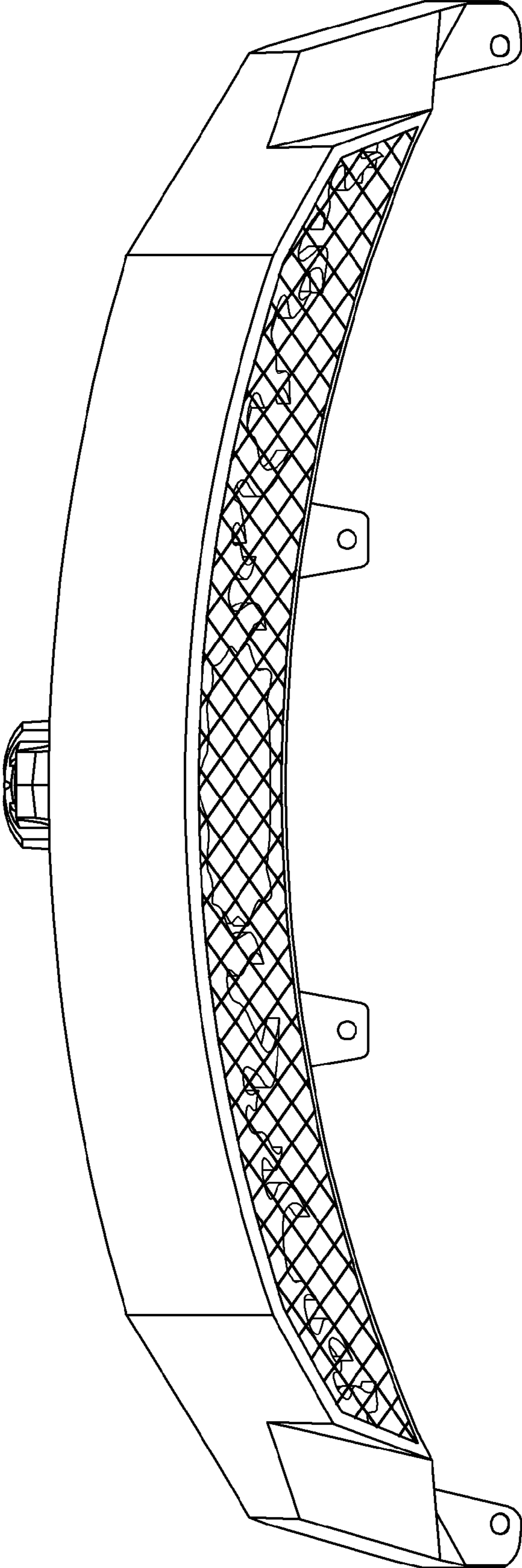

FIG. 7