



US00D626875S

(12) **United States Design Patent**
Cheng

(10) **Patent No.:** **US D626,875 S**

(45) **Date of Patent:** **** Nov. 9, 2010**

(54) **WHISTLE**

2005/0237736 A1* 10/2005 Wimsatt 362/196
2008/0017097 A1* 1/2008 Eventoff 116/137 R

(76) Inventor: **Chin-San Cheng**, No. 4, Lane 130, Min Sheng Road, Changhua City (TW)

* cited by examiner

(**) Term: **14 Years**

Primary Examiner—Caron Veynar
Assistant Examiner—George D Kirschbaum

(21) Appl. No.: **29/366,125**

(22) Filed: **Jul. 20, 2010**

(57) **CLAIM**

The ornamental design for a whistle, as shown and described.

(51) **LOC (9) Cl.** **10-05**

(52) **U.S. Cl.** **D10/119**

(58) **Field of Classification Search** D10/116–120;
446/402, 204–206; 116/137 R

DESCRIPTION

See application file for complete search history.

FIG. 1 is a perspective view of a whistle showing my new design;

FIG. 2 is a front elevation view thereof;

FIG. 3 is a rear elevation view thereof;

FIG. 4 is a left side elevation view thereof;

FIG. 5 is a right side elevation view thereof;

FIG. 6 is a top plan view thereof; and,

FIG. 7 is bottom plan view thereof.

(56) **References Cited**

U.S. PATENT DOCUMENTS

D266,492 S	*	10/1982	Oppermann, Sr. et al. ..	D10/119
D409,939 S	*	5/1999	Sharp et al.	D10/119
D502,421 S	*	3/2005	Cheng	D10/119
D621,734 S	*	8/2010	Hills et al.	D10/119
D622,171 S	*	8/2010	Hills et al.	D10/119
D622,172 S	*	8/2010	Hills et al.	D10/119

1 Claim, 6 Drawing Sheets

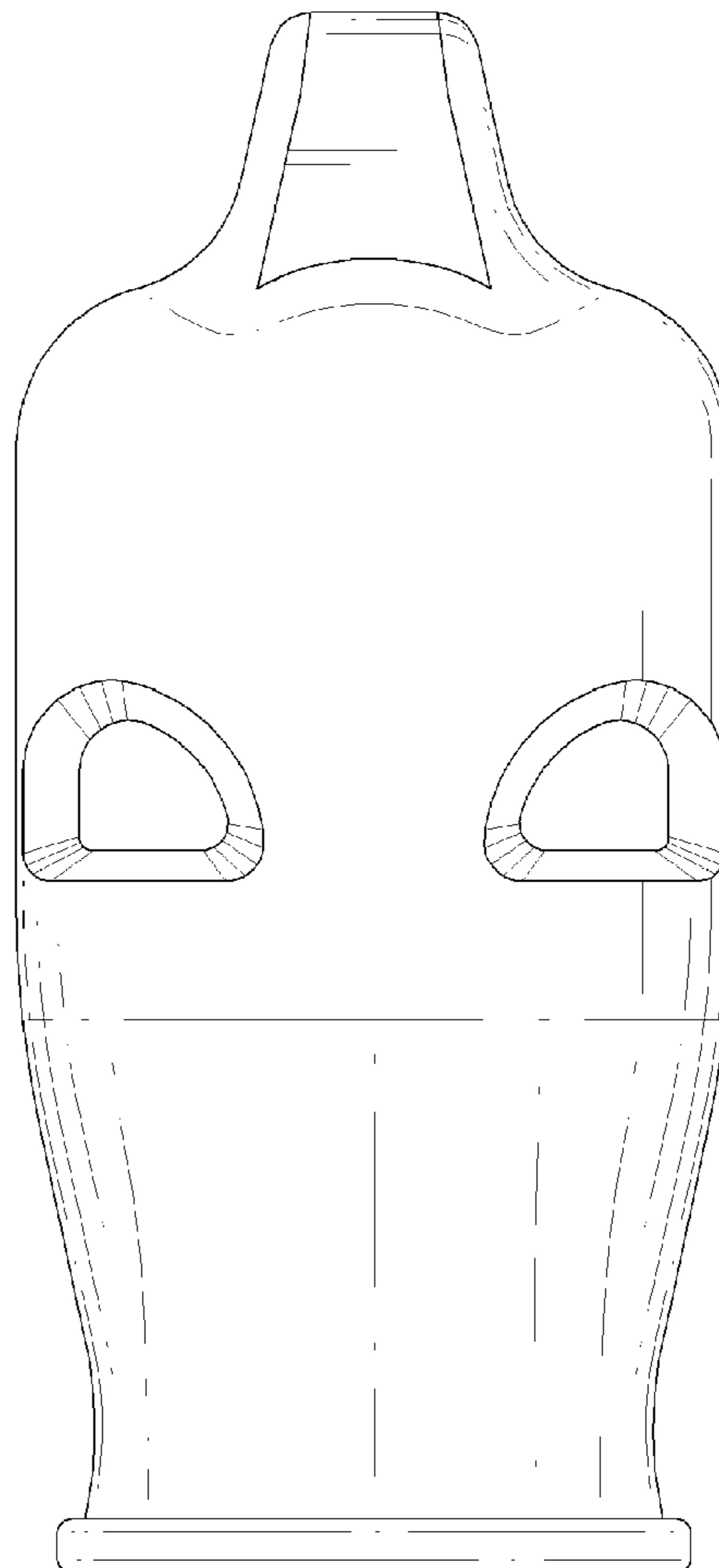
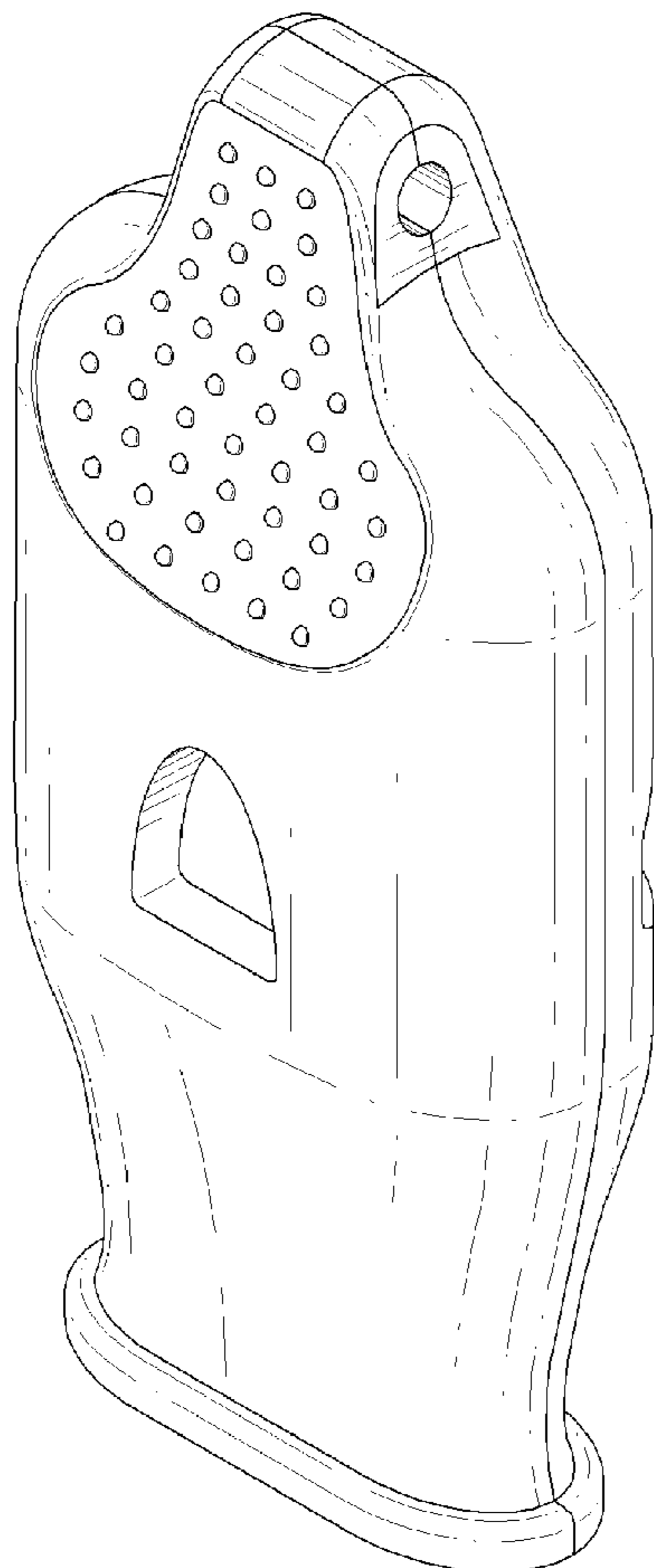

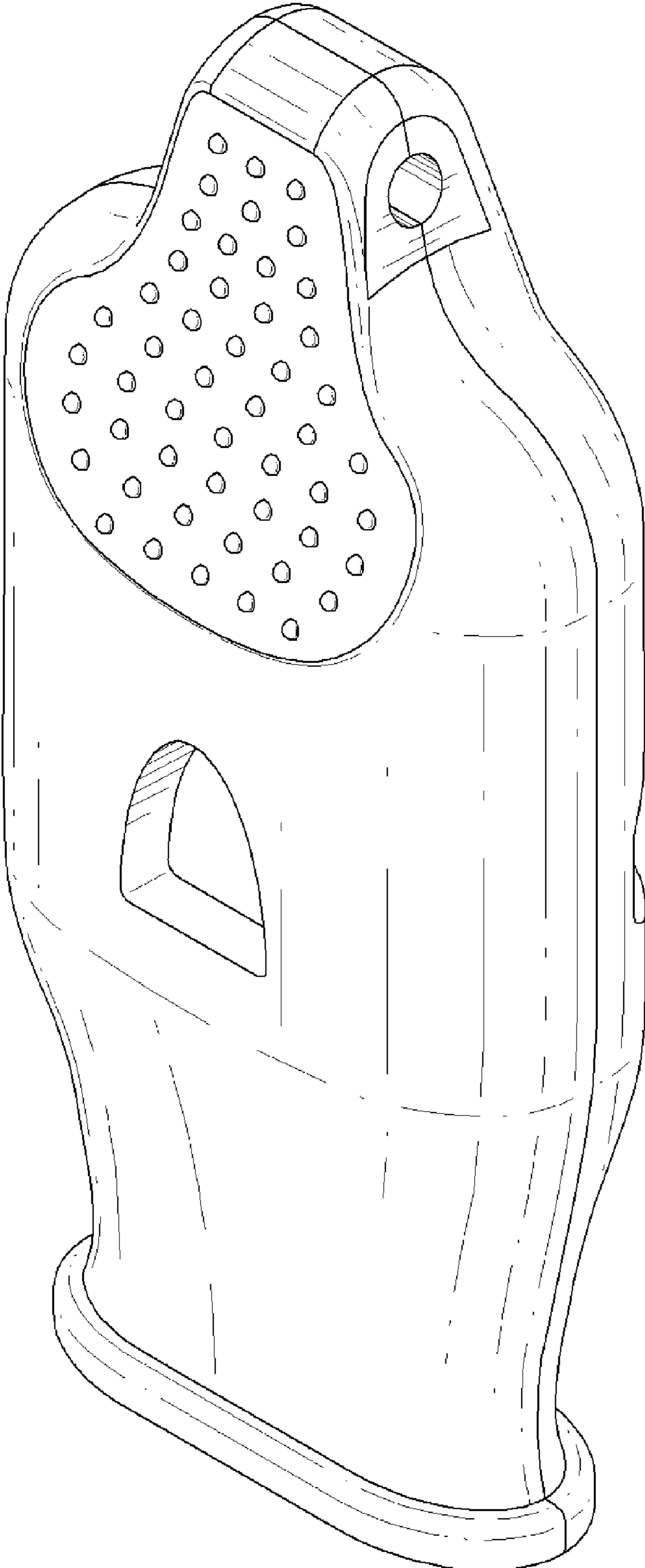

FIG. 1

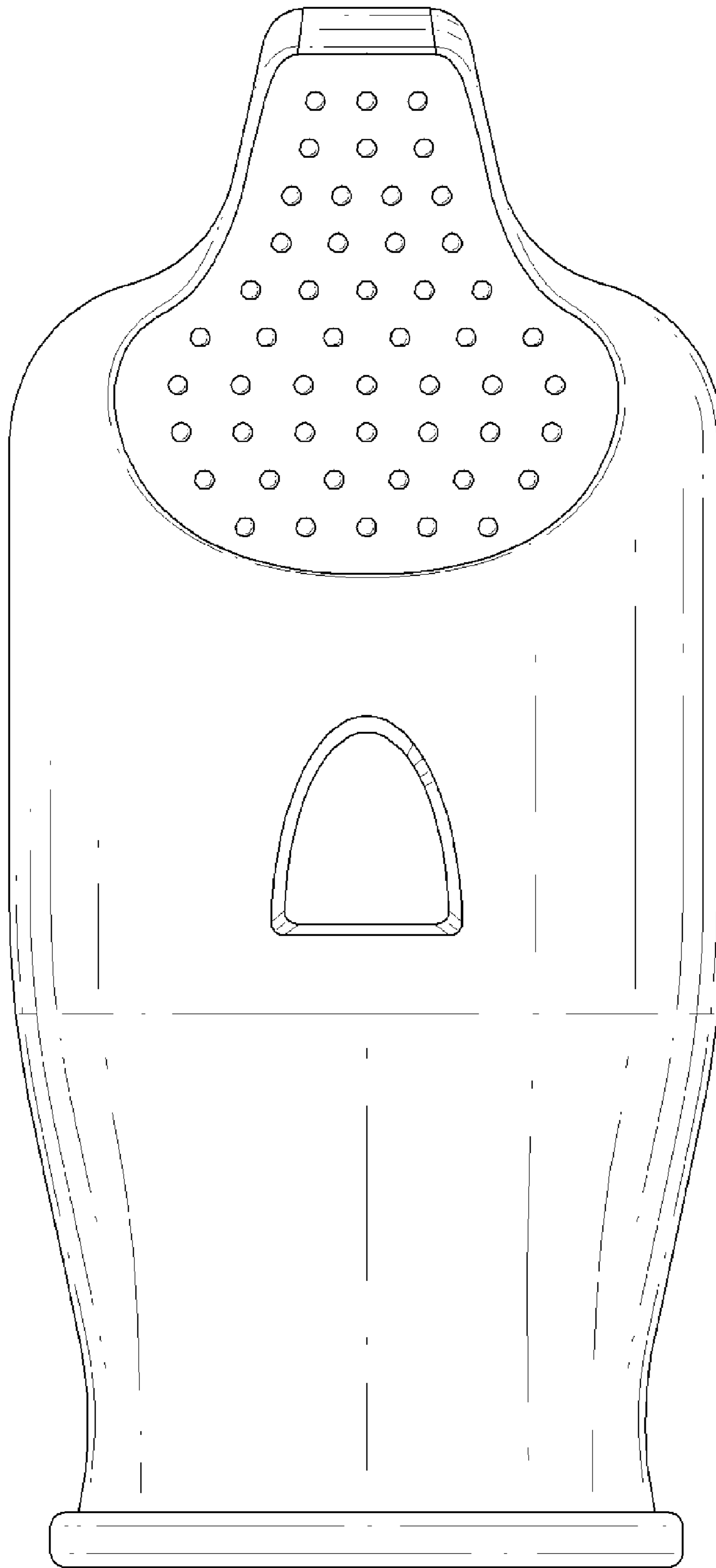

FIG. 2

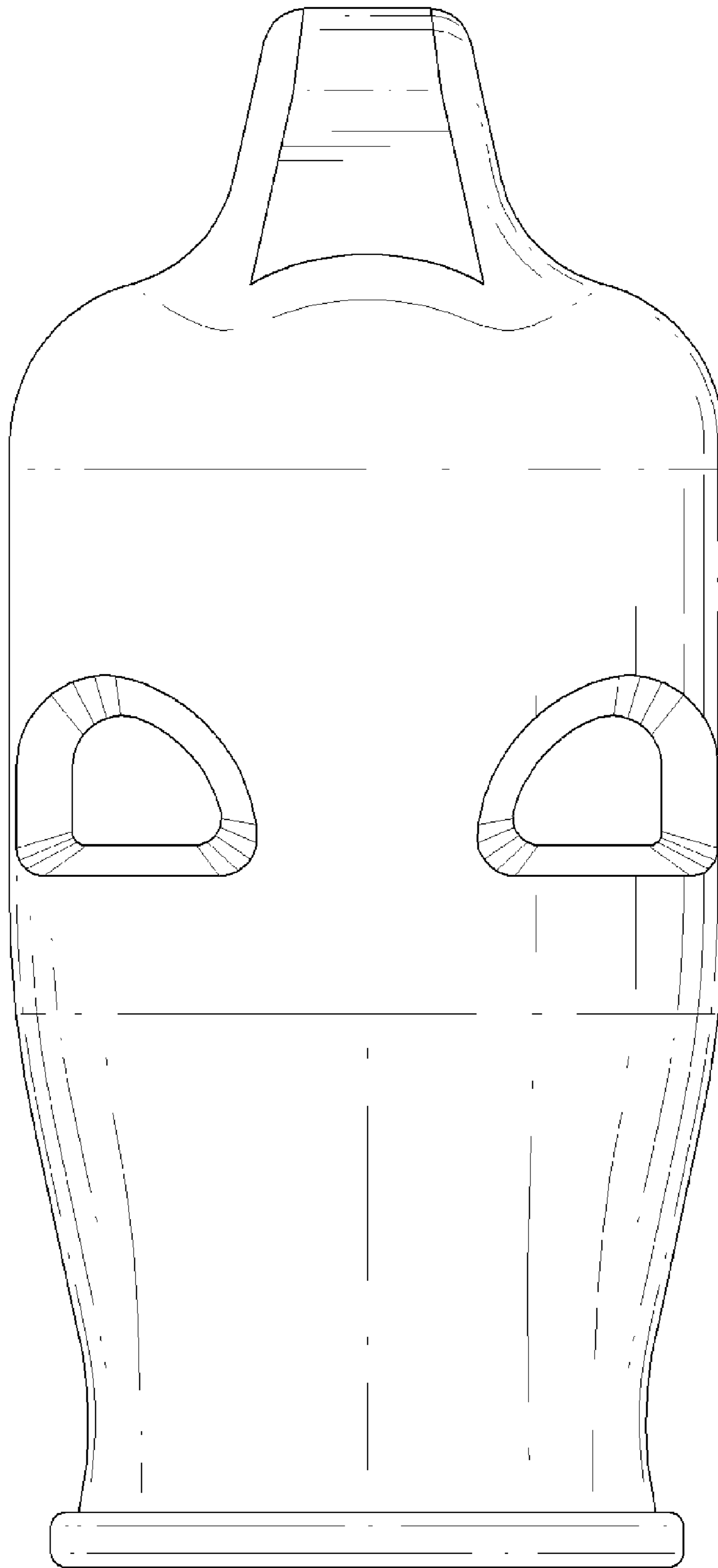

FIG. 3

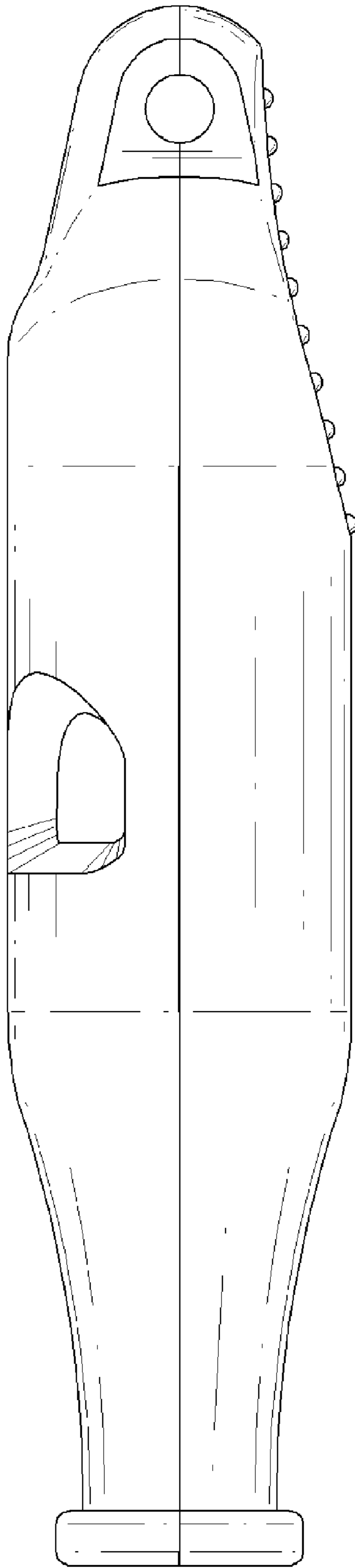

FIG. 4

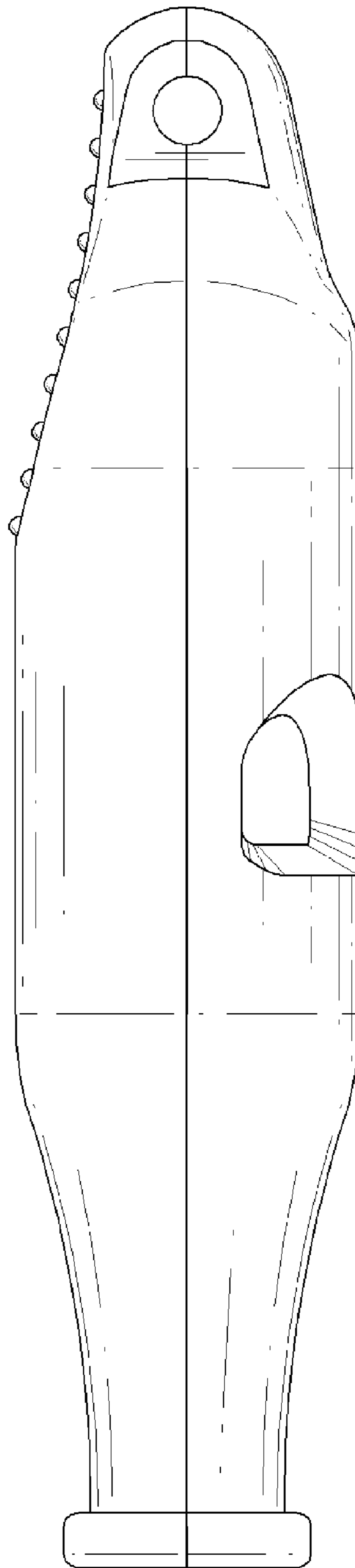

FIG. 5

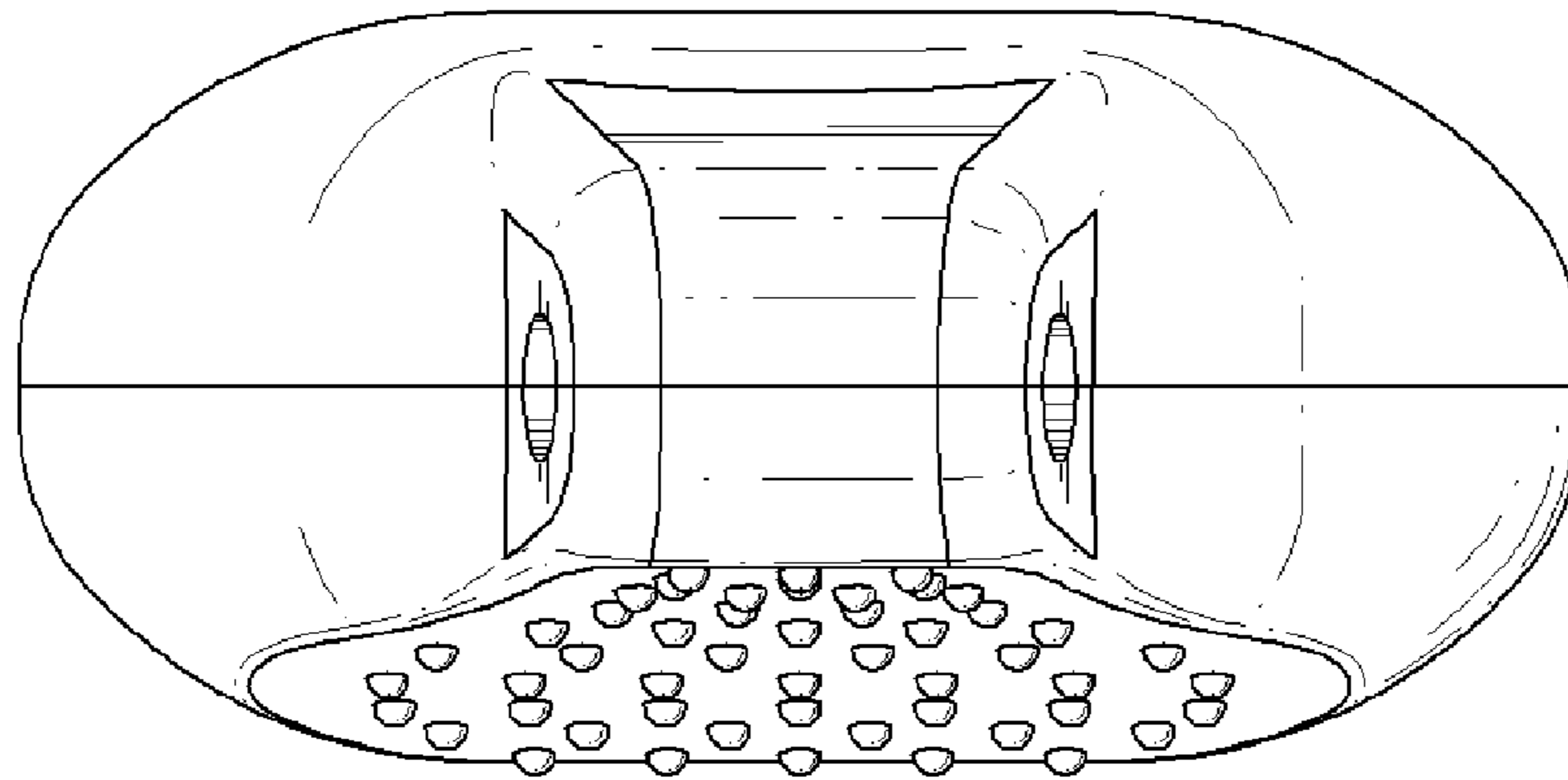

FIG. 6

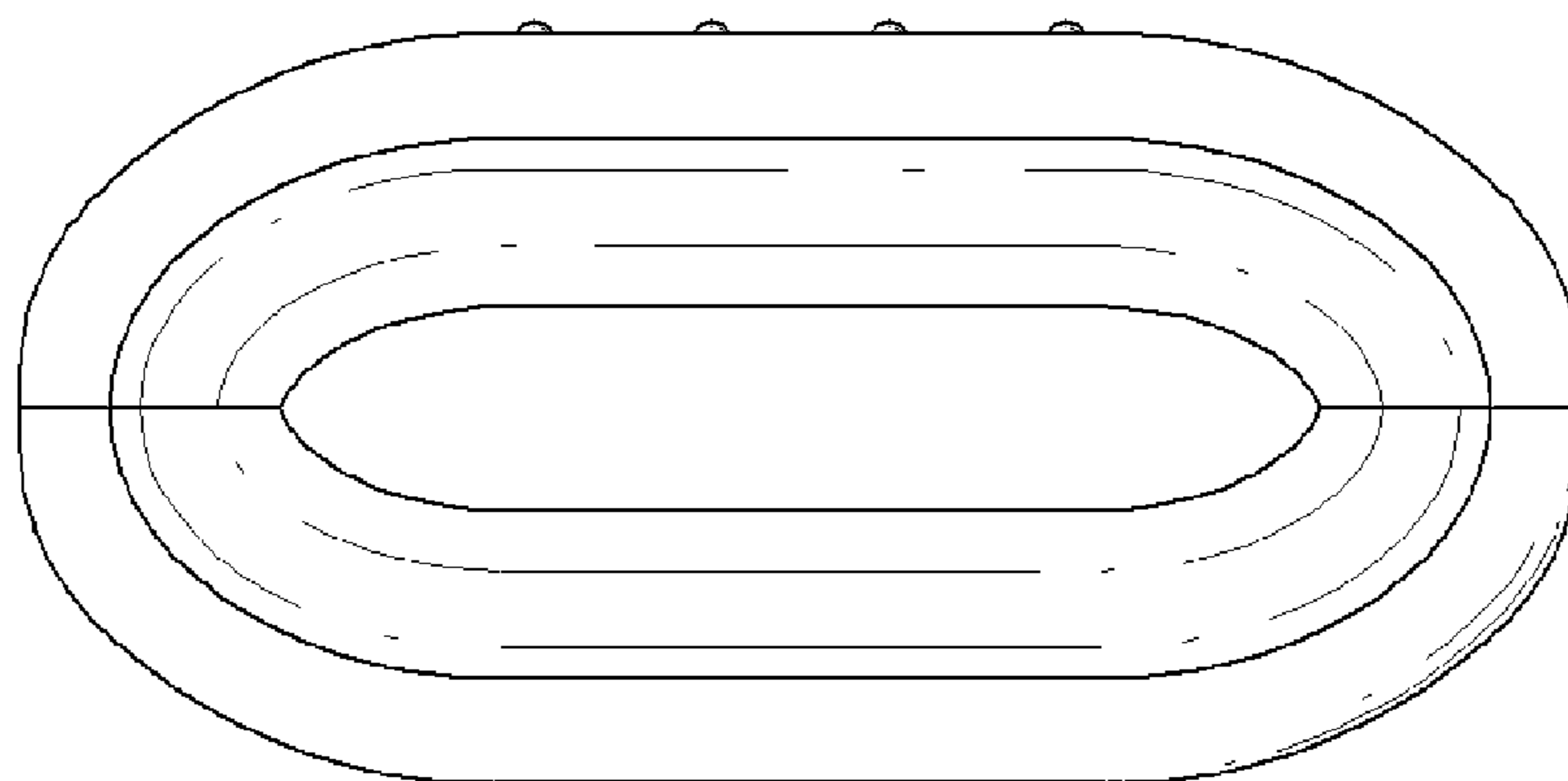

FIG. 7