



US00D626820S

(12) **United States Design Patent**
Boaler et al.

(10) **Patent No.:** **US D626,820 S**
(45) **Date of Patent:** **** Nov. 9, 2010**

(54) **BRACKET FOR SECURING TO AN OVERHEAD STRUCTURAL MEMBER AND SUSPENDING EQUIPMENT THROUGH A WIRE ROPE**

D533,445 S * 12/2006 Janzen D14/432

(75) Inventors: **Derek Boaler**, Sheffield (GB); **John Makin**, Rotherham (GB)

* cited by examiner

Primary Examiner—Patricia Palasik
(74) *Attorney, Agent, or Firm*—Clark Hill PC

(73) Assignee: **Gripple Limited** (GB)

(57) **CLAIM**

(**) Term: **14 Years**

The ornamental design for a bracket for securing to an overhead structural member and suspending equipment through a wire rope, as shown and described.

(21) Appl. No.: **29/329,842**

(22) Filed: **Dec. 22, 2008**

DESCRIPTION

(30) **Foreign Application Priority Data**

Jul. 11, 2008 (EM) 000969159-0001

FIG. 1 is a front right perspective view of the bracket;
FIG. 2 is a rear left perspective view of the bracket;
FIG. 3 is a rear view of the bracket;
FIG. 4 is a left side view of the bracket;
FIG. 5 is a front view of the bracket;
FIG. 6 is a top view of the bracket; and,
FIG. 7 is a bottom view of the bracket.

(51) **LOC (9) Cl.** **08-05**

(52) **U.S. Cl.** **D8/373**

(58) **Field of Classification Search** D8/349,
D8/354, 363, 367, 371, 373, 376, 380; 52/239;
248/200, 300-304, 307, 309.1, 316.1, 339
See application file for complete search history.

The broken lines in the drawings depict unclaimed environmental subject matter.

(56) **References Cited**

U.S. PATENT DOCUMENTS

D310,520 S * 9/1990 Bedard D14/432

1 Claim, 2 Drawing Sheets

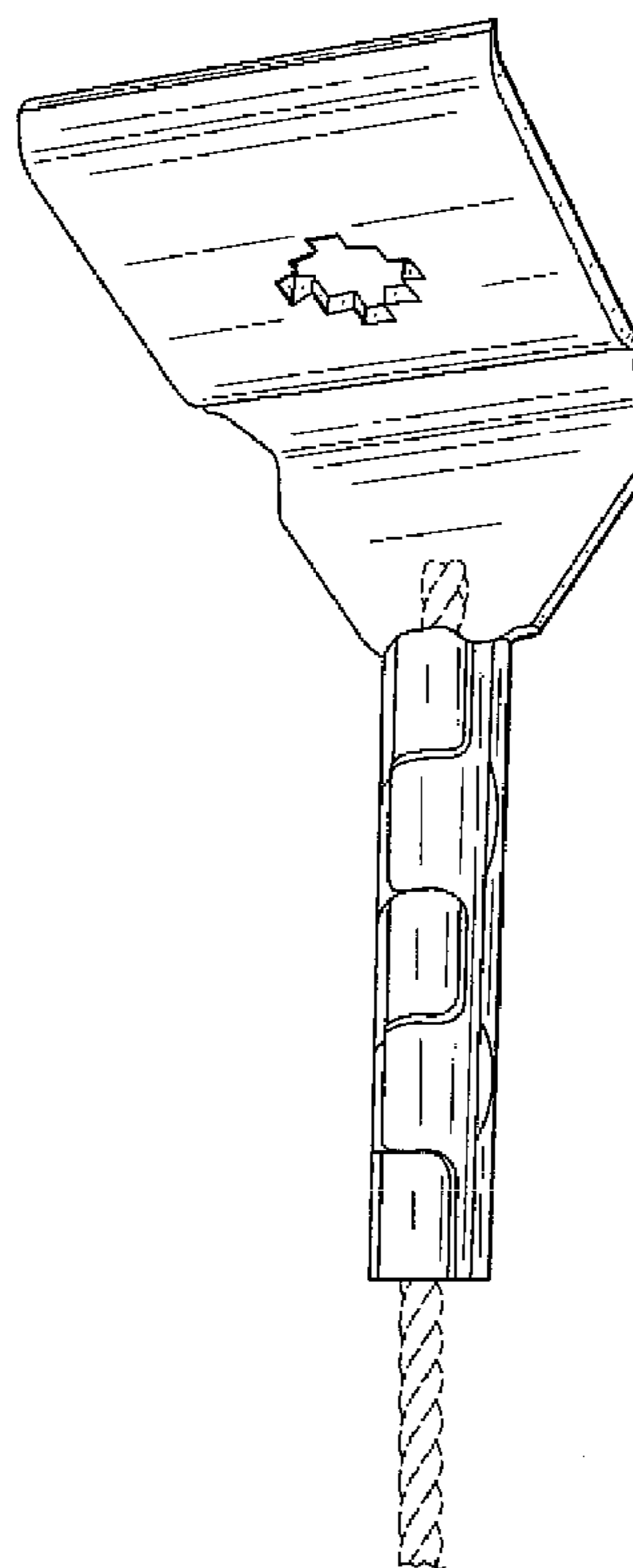
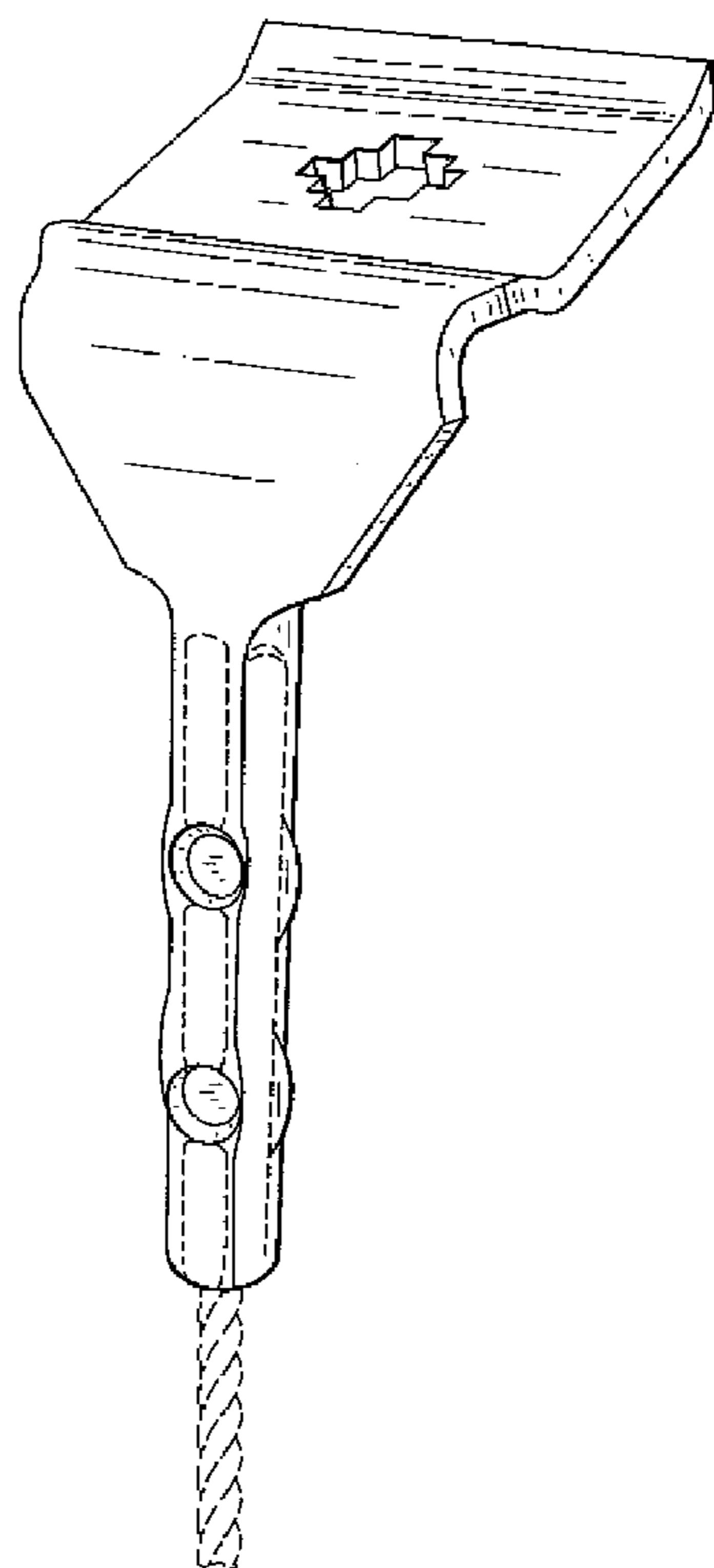

FIG. 1

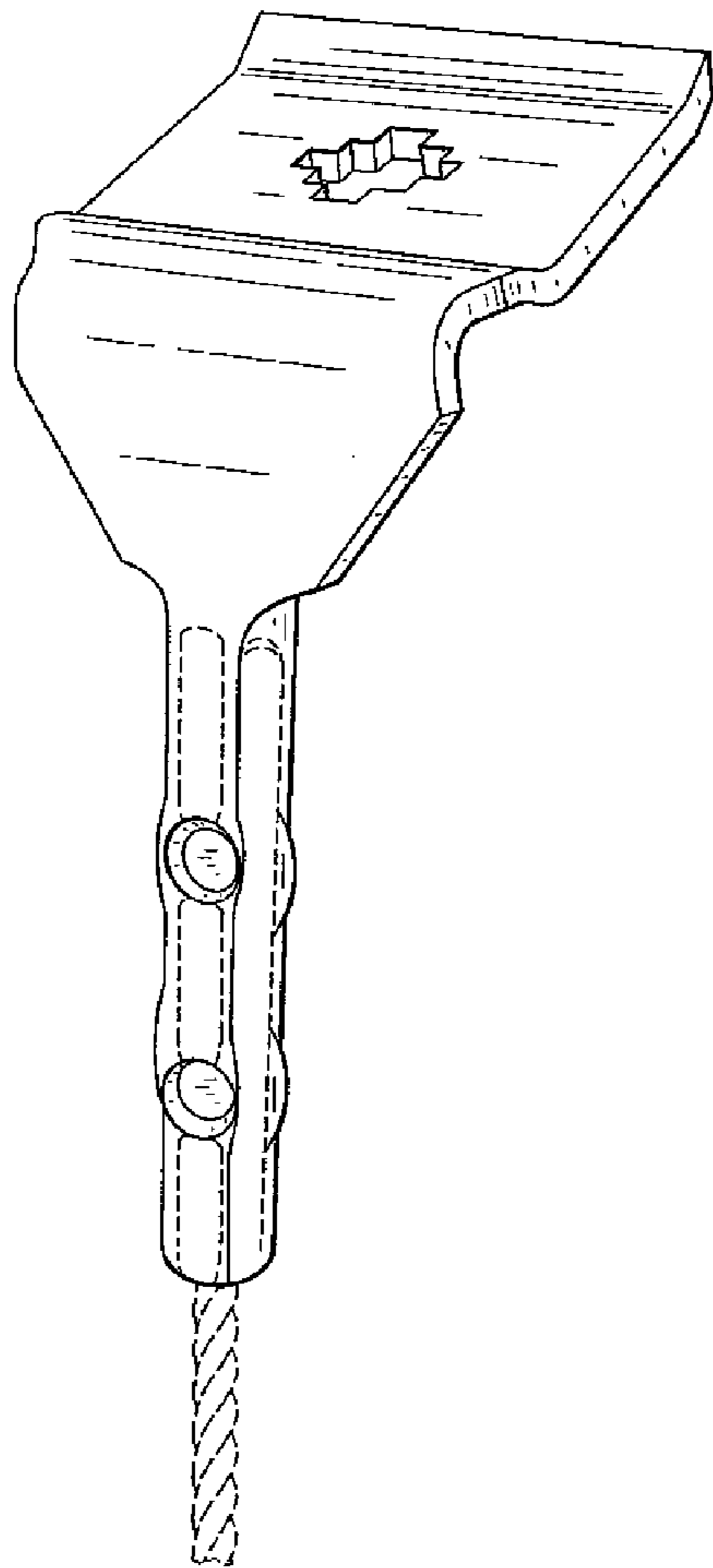

FIG. 2

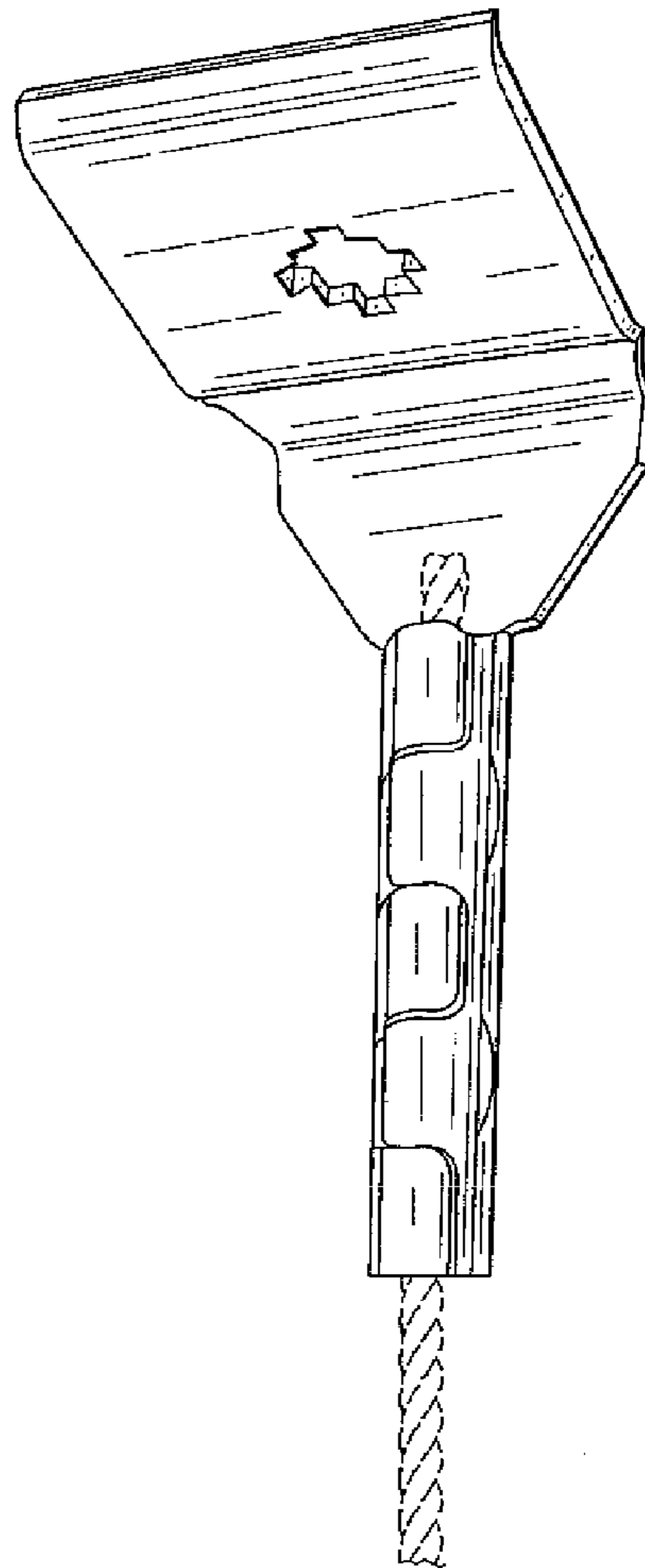

FIG. 3

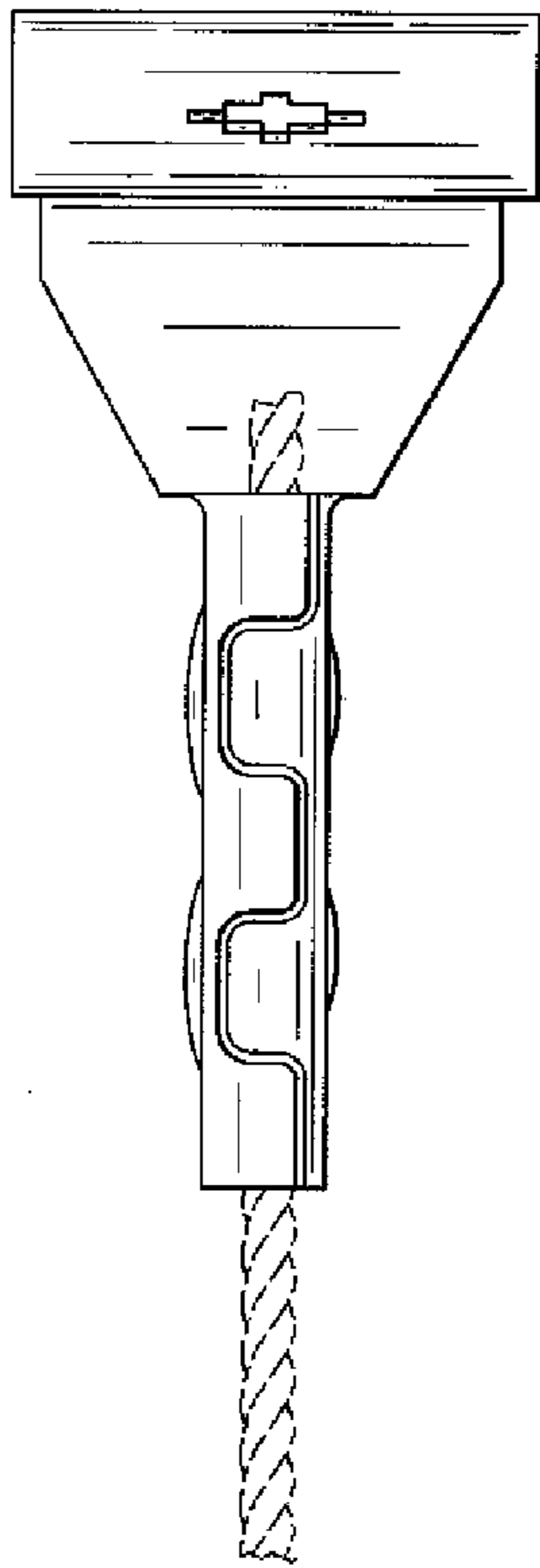

FIG. 4

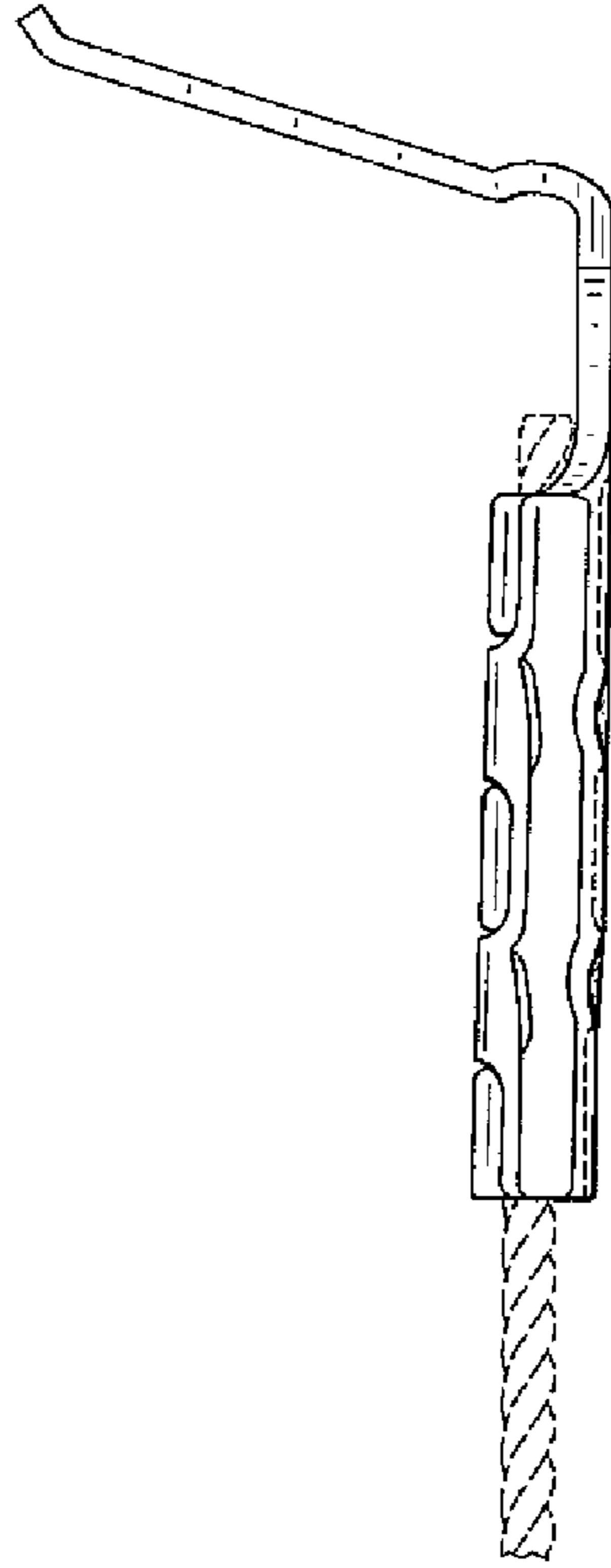

FIG. 5

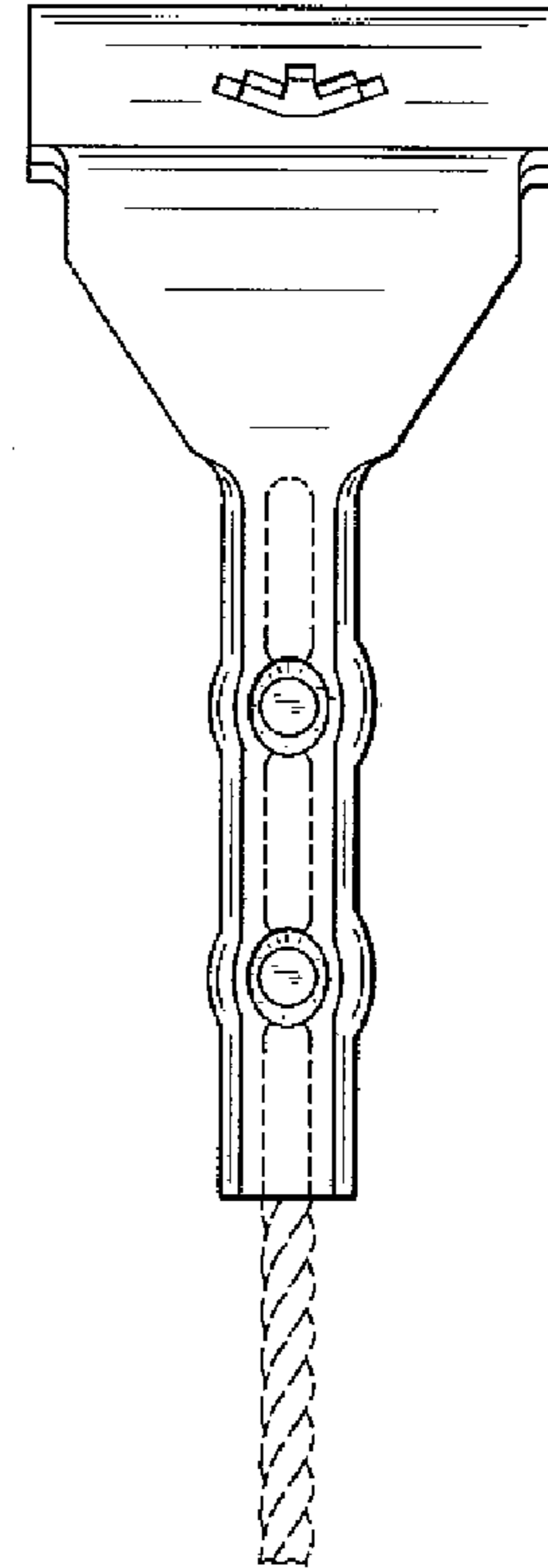

FIG. 6

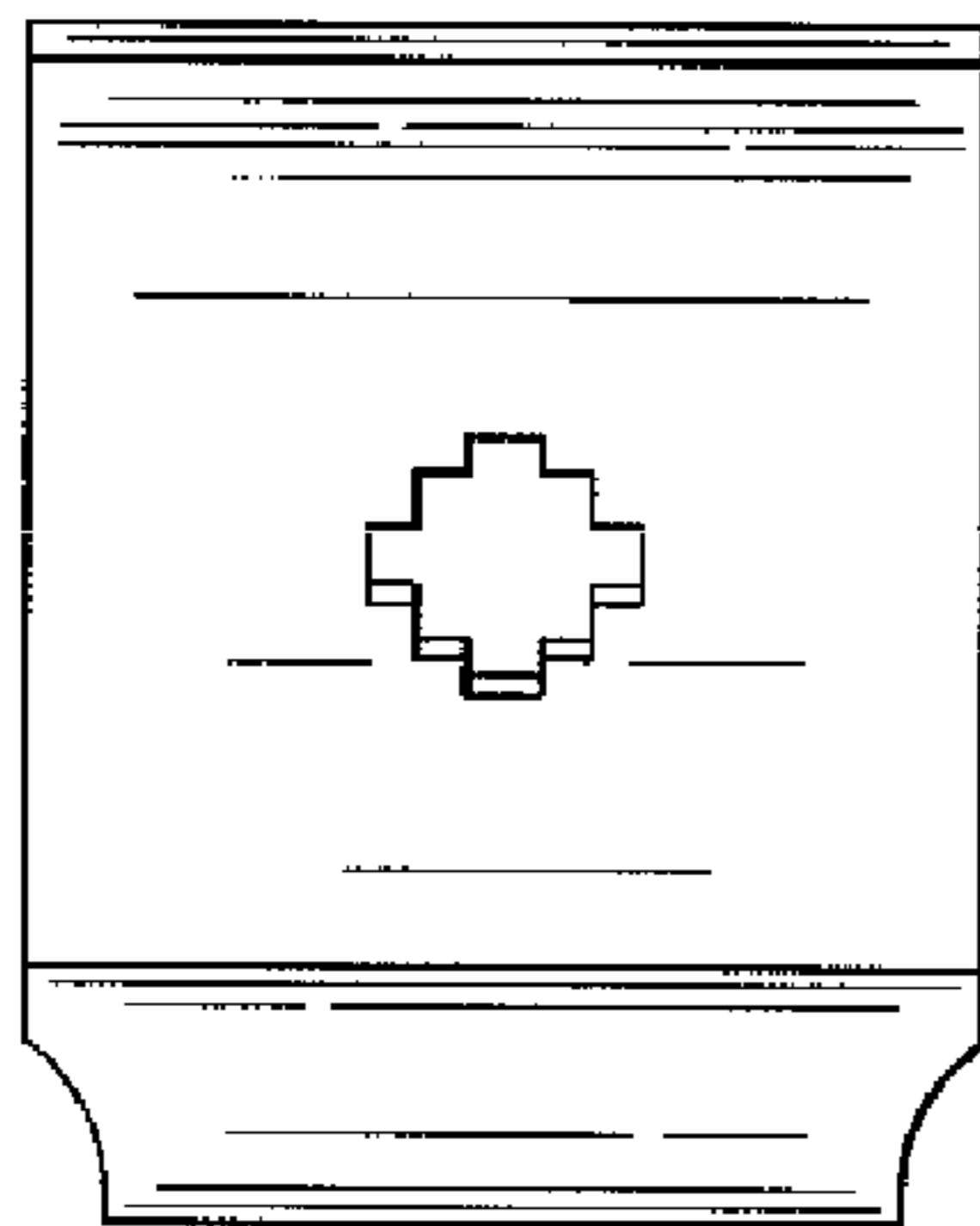

FIG. 7

