



US00D626801S

(12) **United States Design Patent**
Charette

(10) **Patent No.:** **US D626,801 S**
(45) **Date of Patent:** **** Nov. 9, 2010**

(54) **ADJUSTABLE HEAD GROUND SPIKE WITH ROUND RINGS**

(76) Inventor: **Pierre Charette**, 4521 rue des Carouges, Notre-Dame-du-Mont-Carmel, Quebec, G0X 3J0 (CA)

(**) Term: **14 Years**

(21) Appl. No.: **29/347,306**

(22) Filed: **Nov. 27, 2009**

(51) **LOC (9) Cl.** **08-01**

(52) **U.S. Cl.** **D8/1**

(58) **Field of Classification Search** D8/1,
D8/388; D26/138, 67; 47/47; 135/118;
248/156, 87

See application file for complete search history.

(56) **References Cited**

U.S. PATENT DOCUMENTS

D243,614 S *	3/1977	Russo	D25/126
D419,403 S *	1/2000	Halil, Jr.	D8/1
D553,919 S *	10/2007	Gross et al.	D8/1
D572,986 S *	7/2008	Zhu et al.	D8/1
D576,020 S *	9/2008	Arcati	D8/349
D577,966 S *	10/2008	Cosimo	D8/1
D582,732 S *	12/2008	Cox	D8/1
7,472,874 B2 *	1/2009	Gross et al.	248/156

* cited by examiner

Primary Examiner—Holly H Baynham

Assistant Examiner—Sheryl Lane

(74) *Attorney, Agent, or Firm*—Welsh Flaxman & Gitler LLC

(57) **CLAIM**

The ornamental design for an adjustable head ground spike with round rings, as shown, and described.

DESCRIPTION

FIG. 1 is a front view of the adjustable head ground spike with round rings;

FIG. 2 is a back view of the adjustable head ground spike with round rings;

FIG. 3 is a left-side view of the adjustable head ground spike with round rings;

FIG. 4 is a right side view of the adjustable head ground spike with round rings;

FIG. 5 is a top view of the adjustable head ground spike with round rings;

FIG. 6 is a bottom view of the adjustable head ground spike with round rings;

FIG. 7 is a perspective view of the adjustable head ground spike with round rings;

FIG. 8 is a front view of an alternate embodiment of the adjustable head ground spike with round rings;

FIG. 9 is a back view of an alternate embodiment of the adjustable head ground spike with round rings;

FIG. 10 is a left-side view of an alternate embodiment of the adjustable head ground spike with round rings;

FIG. 11 is a right side view of an alternate embodiment of the adjustable head ground spike with round rings;

FIG. 12 is a top view of an alternate embodiment of the adjustable head ground spike with round rings;

FIG. 13 is a bottom view of an alternate embodiment of the adjustable head ground spike with round rings; and,

FIG. 14 is a perspective view of an alternate embodiment of the adjustable head ground spike with round rings.

1 Claim, 14 Drawing Sheets

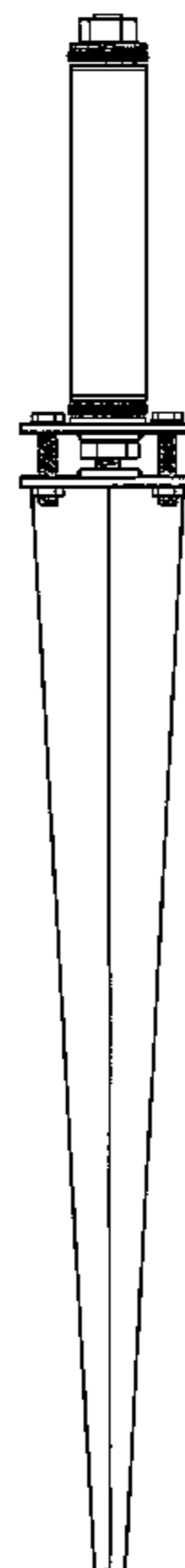

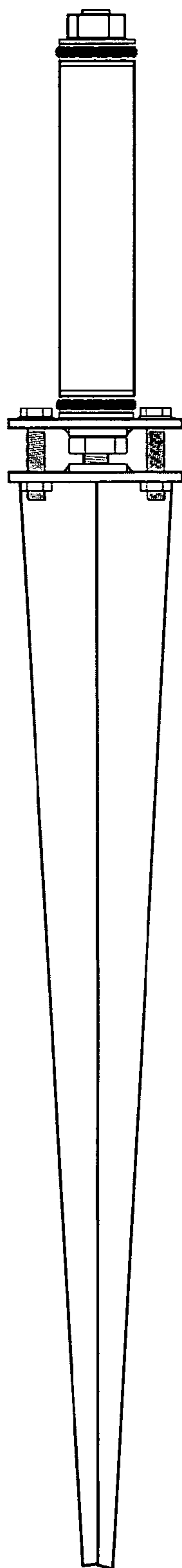

FIG. 1

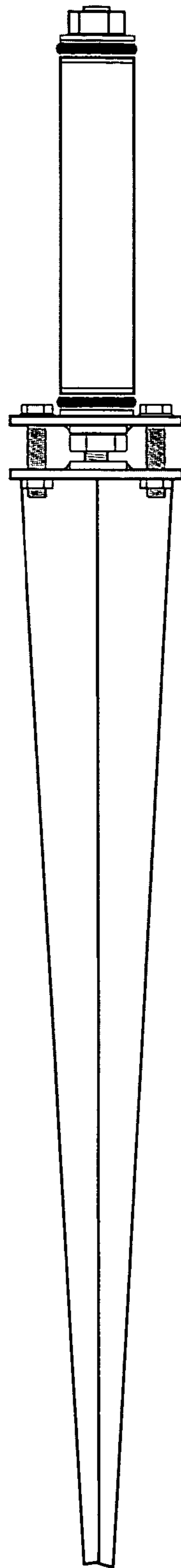

FIG. 2

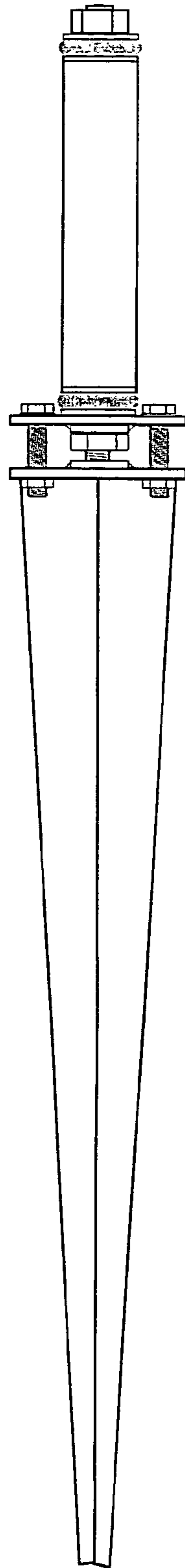

FIG. 3

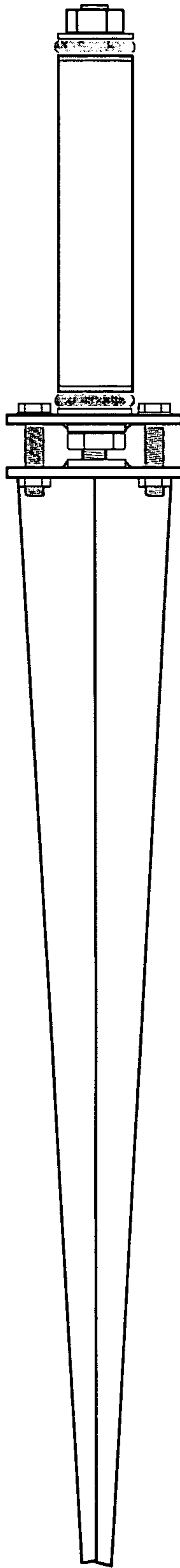

FIG. 4

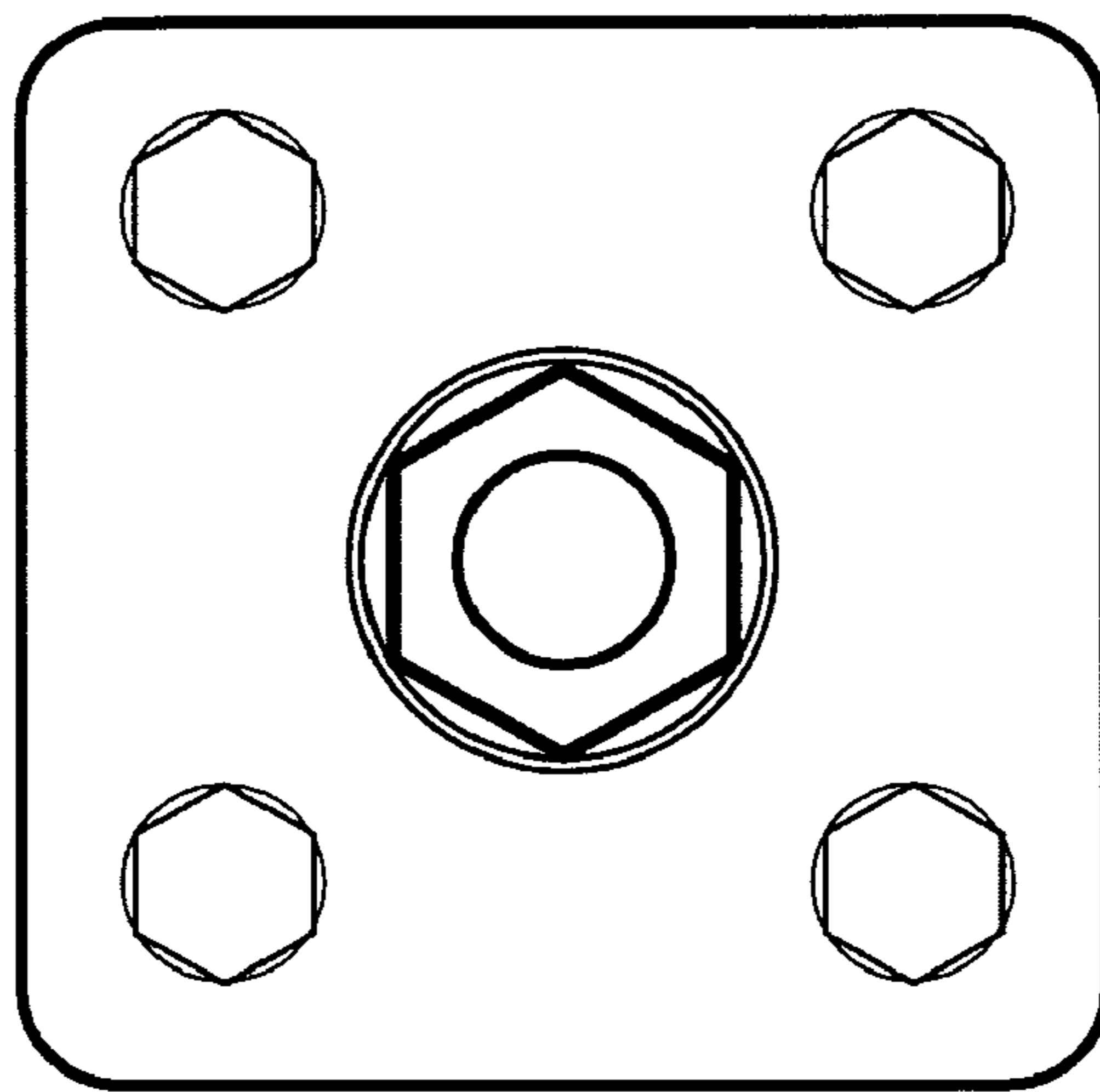

FIG. 5

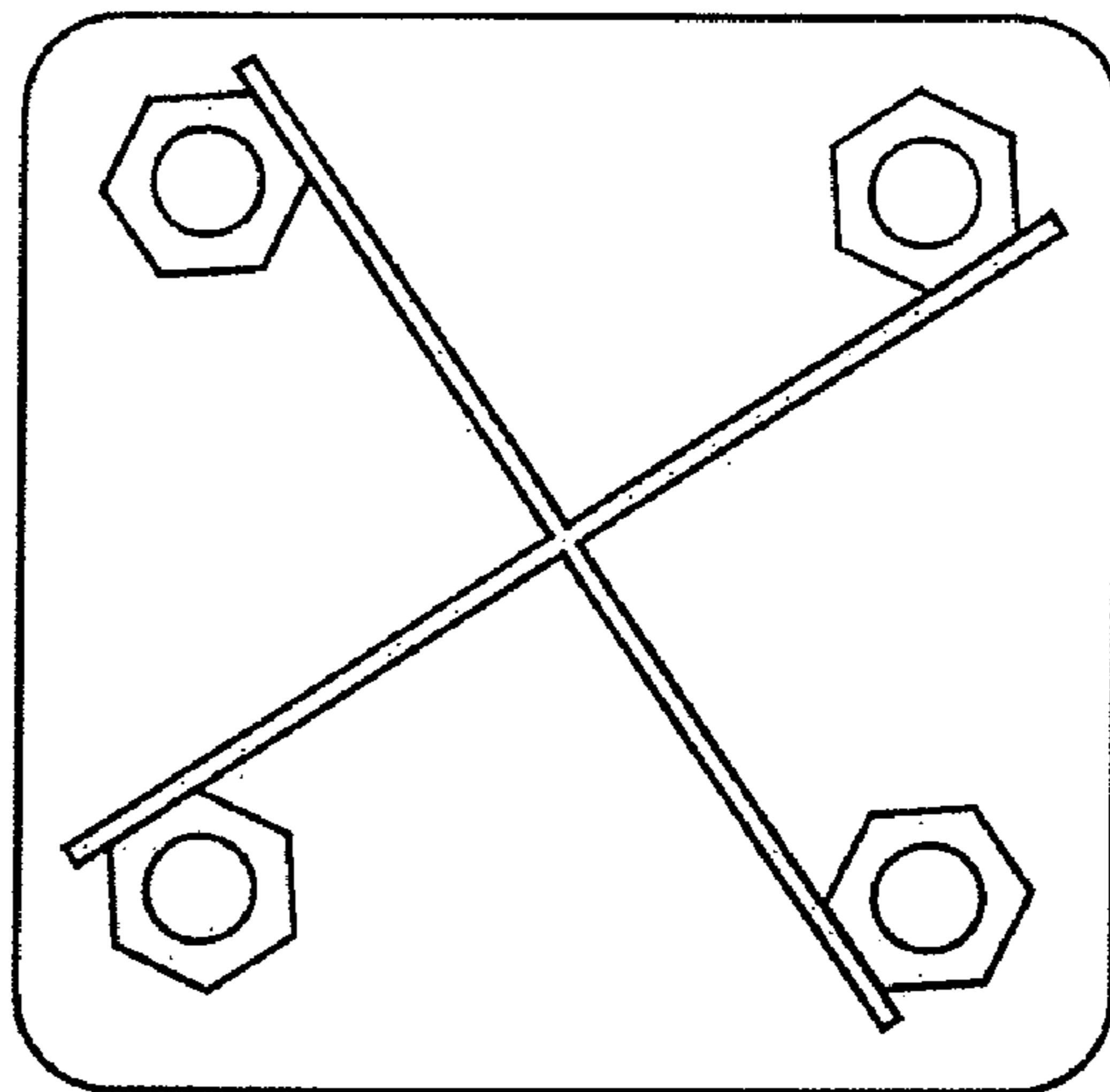

FIG. 6

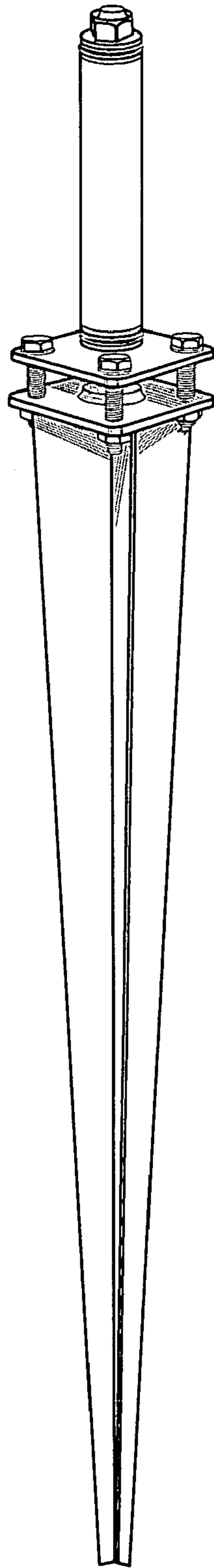

FIG. 7

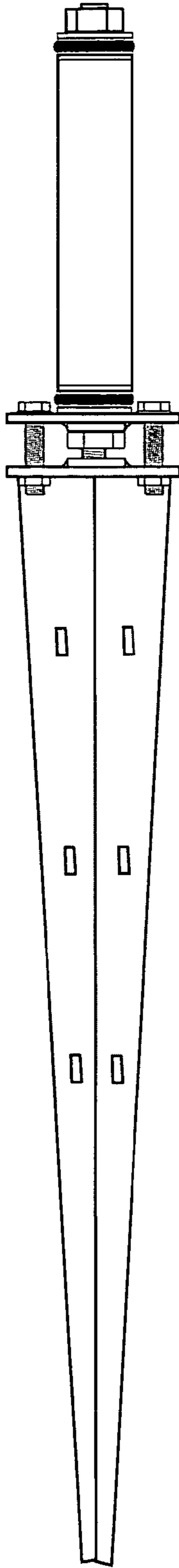

FIG. 8

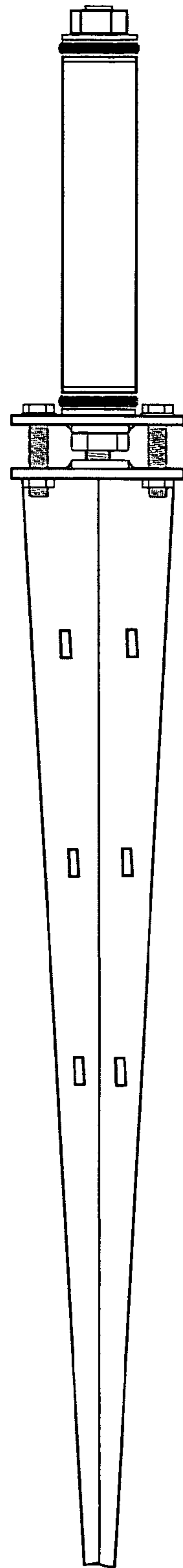

FIG. 9

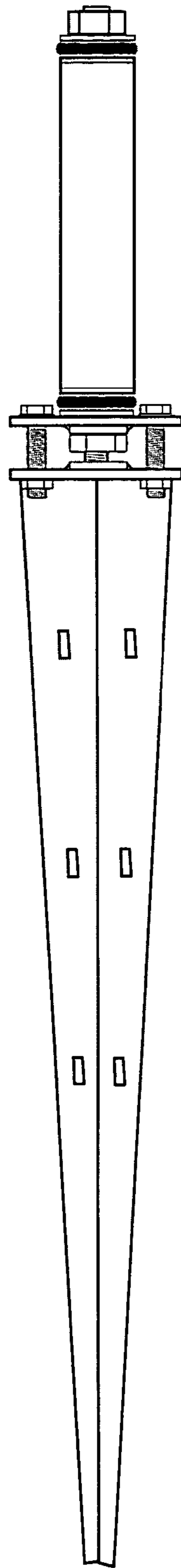

FIG. 10

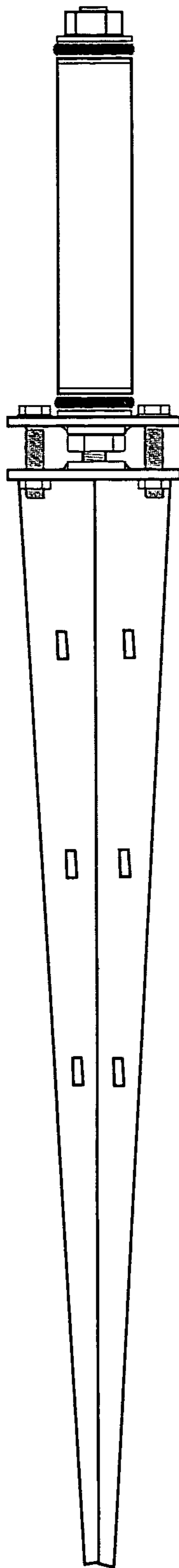

FIG. 11

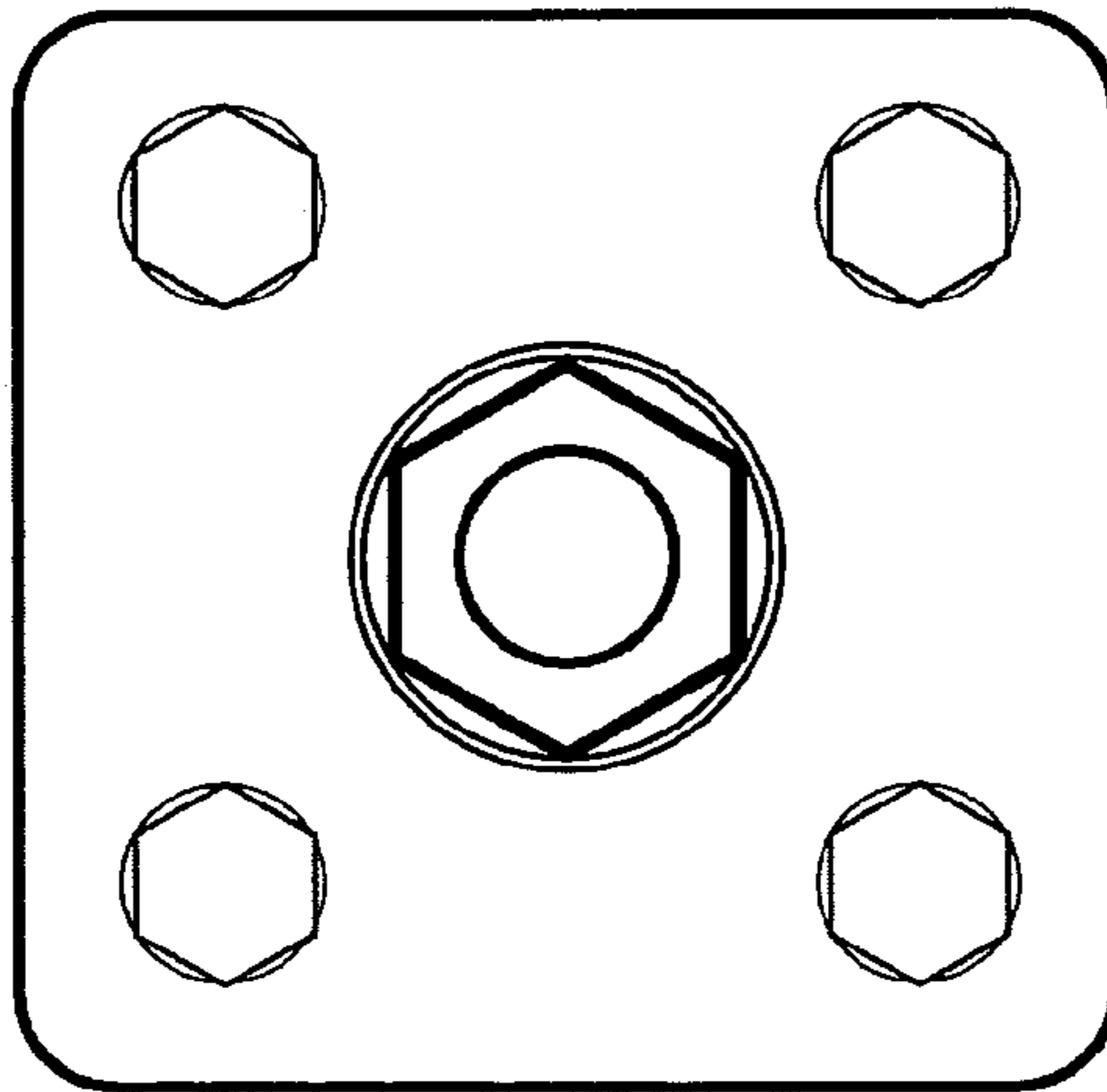

FIG. 12

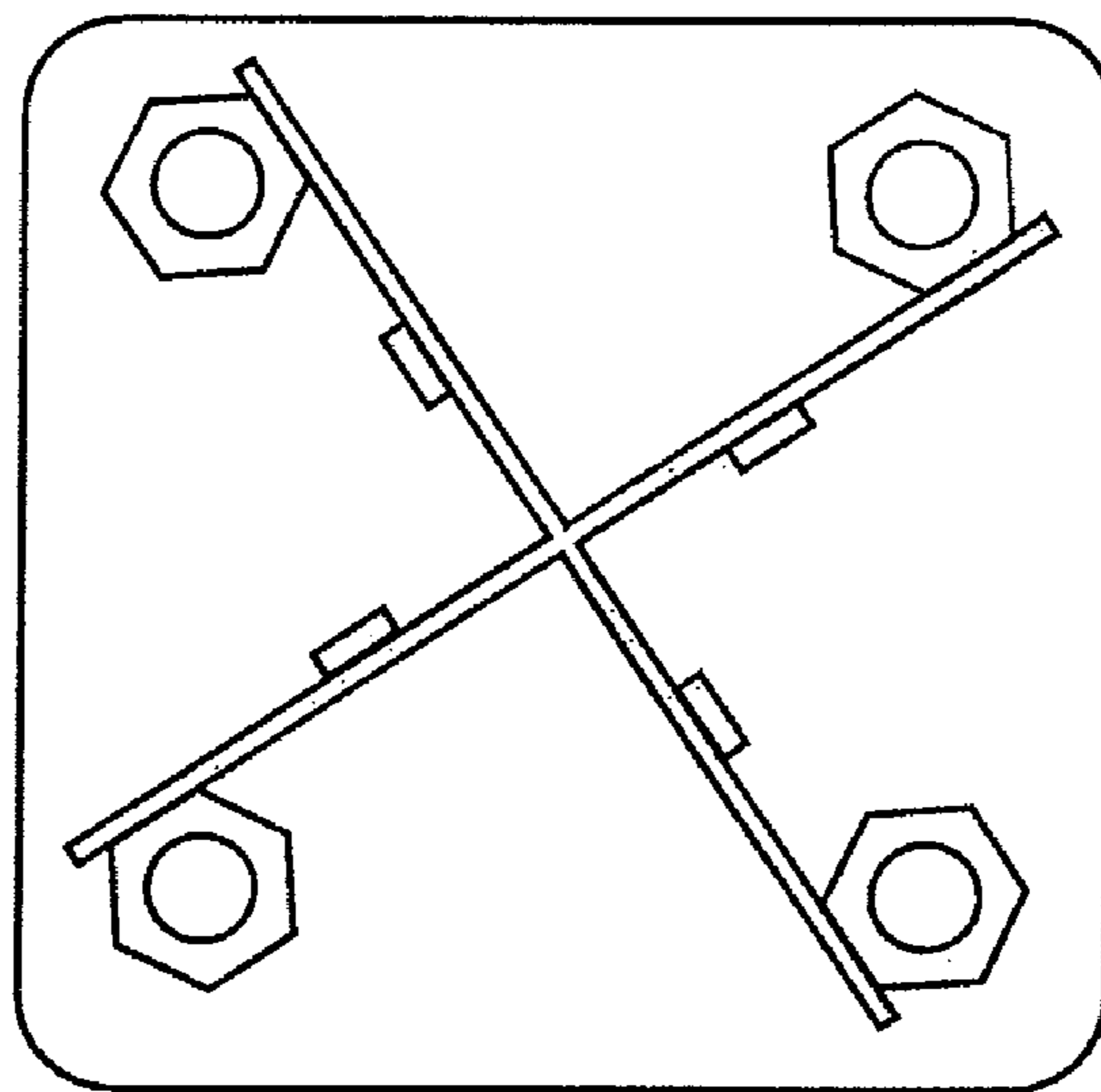

FIG. 13

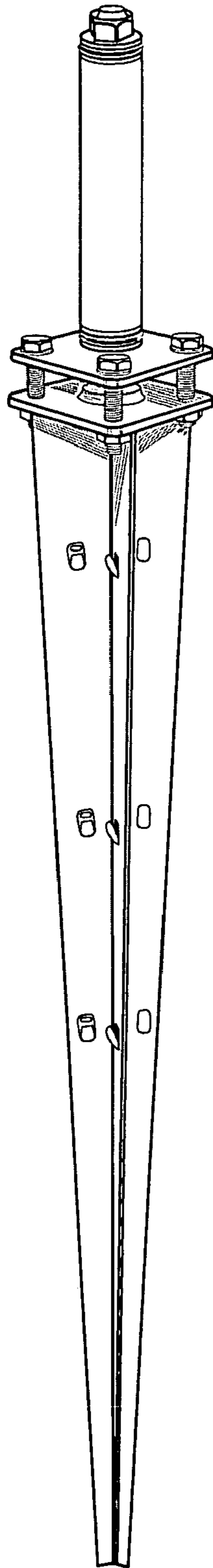

FIG. 14