



US00D626672S

(12) **United States Design Patent**  
**De Rubertis**

(10) **Patent No.:** **US D626,672 S**  
(45) **Date of Patent:** **\*\* Nov. 2, 2010**

(54) **PORTABLE LAMP**

(75) Inventor: **Pierluigi De Rubertis**, Parma (IT)

(73) Assignee: **Fasangas S.R.L.**, Surbo (IT)

(\*\*) Term: **14 Years**

(21) Appl. No.: **29/309,678**

(22) Filed: **Sep. 25, 2008**

(30) **Foreign Application Priority Data**

Jun. 23, 2008 (EM) ..... 000957469

(51) **LOC (9) Cl.** ..... **26-02**

(52) **U.S. Cl.** ..... **D26/38**

(58) **Field of Classification Search** ..... D26/37,  
D26/38, 39, 40, 42, 46, 51, 63-66; 362/103,  
362/105, 108, 157, 158, 183, 184, 194-196,  
362/200, 201, 208

See application file for complete search history.

(56) **References Cited**

**U.S. PATENT DOCUMENTS**

D409,776 S	5/1999	Ghode et al.	
D501,687 S	2/2005	Kovacik et al.	
D501,688 S	2/2005	Kovacik et al.	
D504,968 S	5/2005	Bayat et al.	
D505,217 S *	5/2005	Bayat et al.	D26/42
D519,659 S	4/2006	Yuen	
D523,577 S	6/2006	Bayat et al.	
D535,770 S *	1/2007	Yuen	D26/38
D536,812 S *	2/2007	Bayat et al.	D26/37
D540,484 S	4/2007	Bayat et al.	
D541,962 S	5/2007	Bayat et al.	
D555,263 S *	11/2007	Consorte et al.	D26/37
D556,926 S *	12/2007	Thirouin	D26/37
D566,312 S *	4/2008	Lui	D26/46

D574,741 S \* 8/2008 Gadsden ..... D10/114  
D597,692 S \* 8/2009 Jiang ..... D26/42

\* cited by examiner

*Primary Examiner*—Charles A Rademaker

*Assistant Examiner*—Carissa C Fitts

(74) *Attorney, Agent, or Firm*—Modiano & Associati; Albert Josif; Daniel J. O’Byrne

(57) **CLAIM**

The ornamental design for “portable lamp”, as shown.

**DESCRIPTION**

FIG. 1 is a perspective view of the portable lamp according to the invention in the closed configuration;

FIG. 2 is a front view thereof;

FIG. 3 is a rear view thereof;

FIG. 4 is a left side view thereof;

FIG. 5 is a right side view thereof;

FIG. 6 is a top view thereof;

FIG. 7 is a bottom view thereof;

FIG. 8 is a perspective view of the portable lamp according to the invention in the open configuration;

FIG. 9 is a front view thereof;

FIG. 10 is a rear view thereof;

FIG. 11 is a left side view thereof;

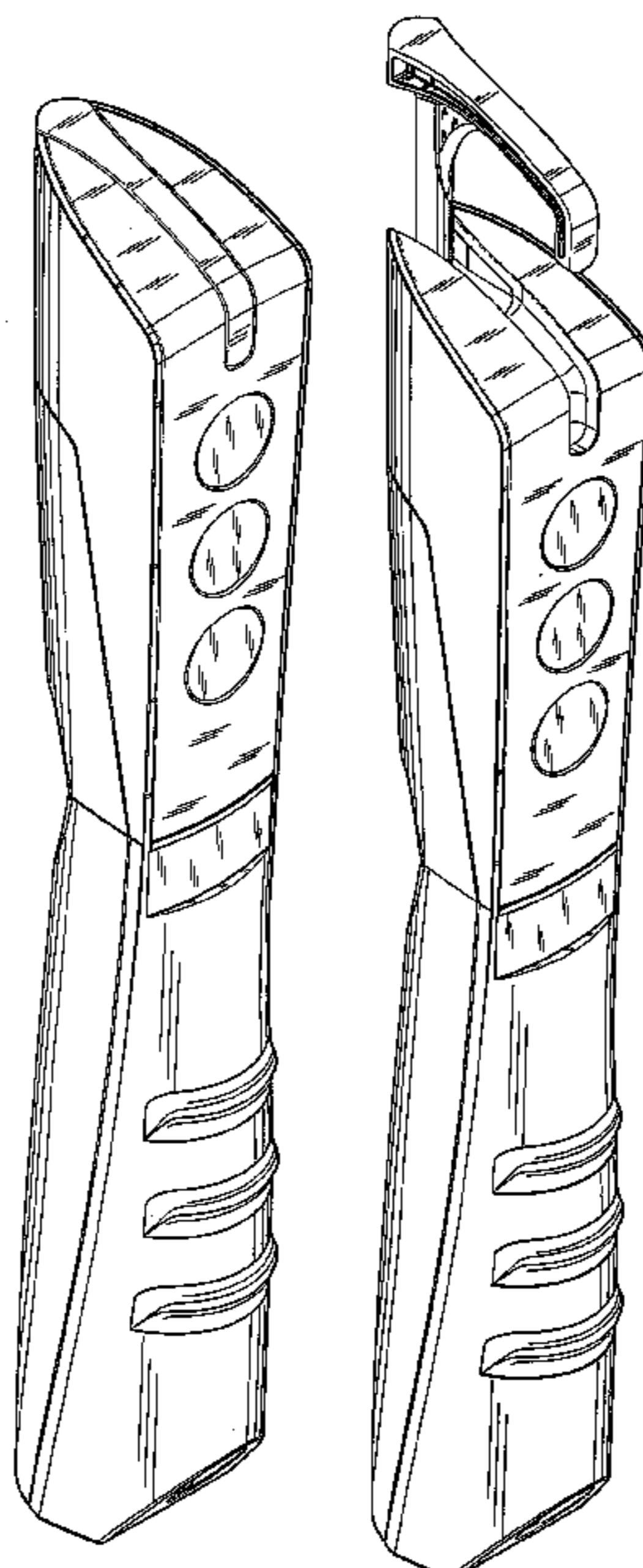
FIG. 12 is a right side view thereof;

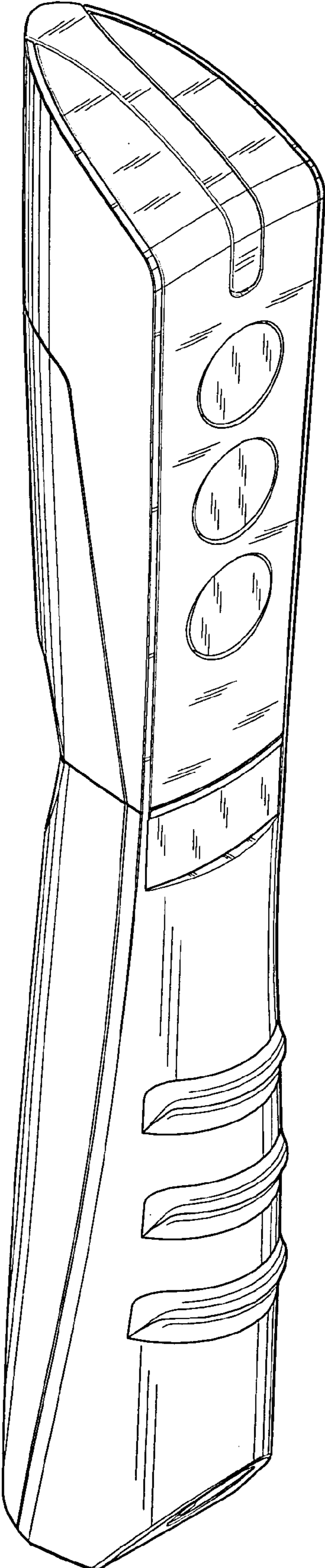
FIG. 13 is a top view thereof; and,

FIG. 14 is a bottom view thereof.

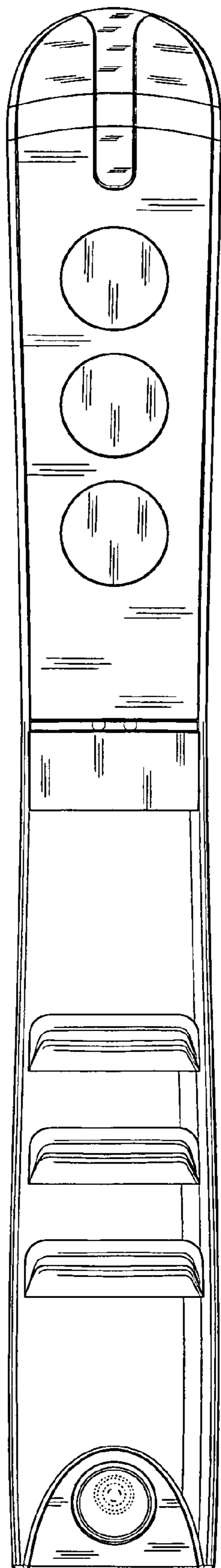
The broken lines in FIGS. 2, 3, 7, 9, 10, and 14 form no part of the claimed design.

**1 Claim, 12 Drawing Sheets**

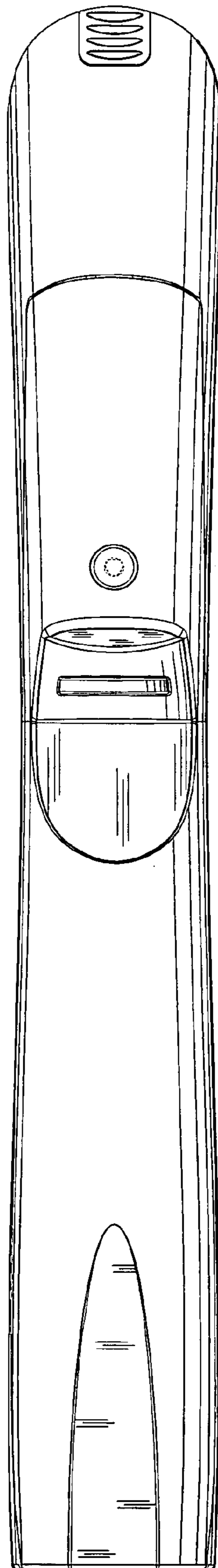




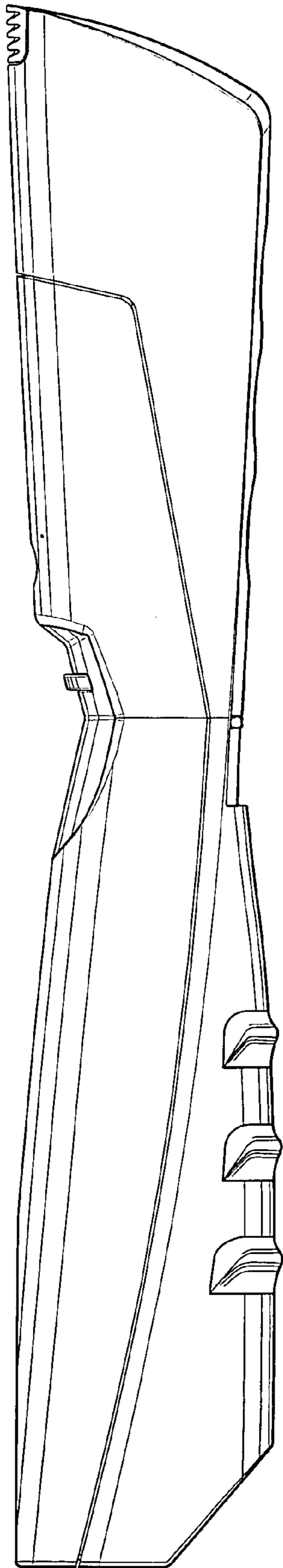
*Fig. 1*



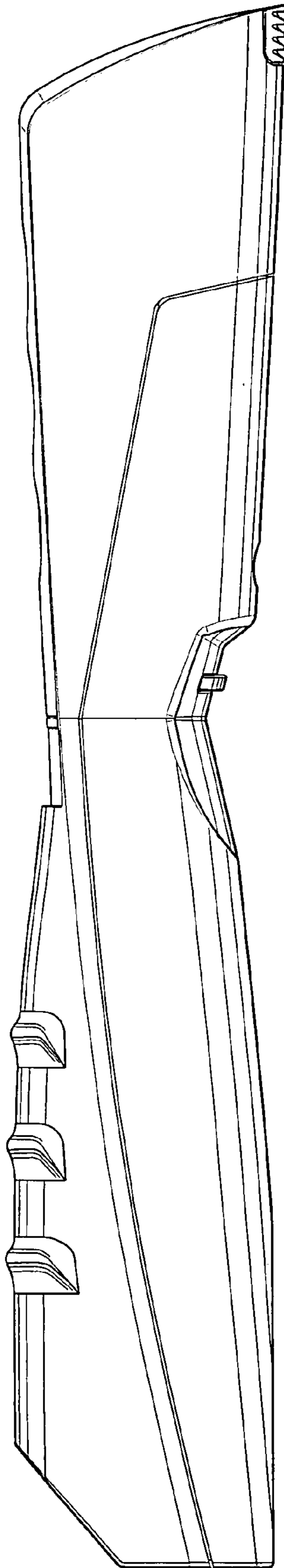
*Fig. 2*



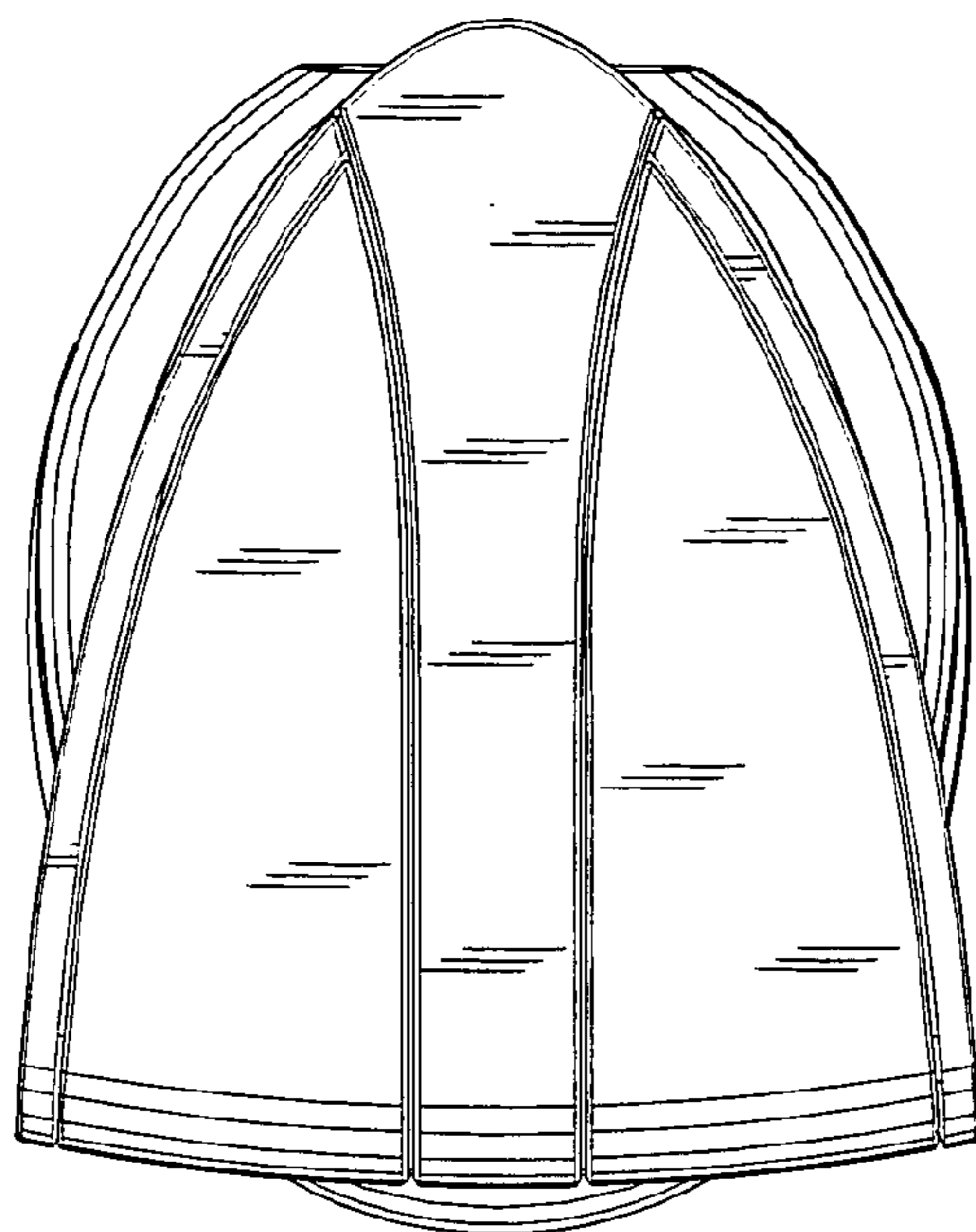
*Fig. 3*



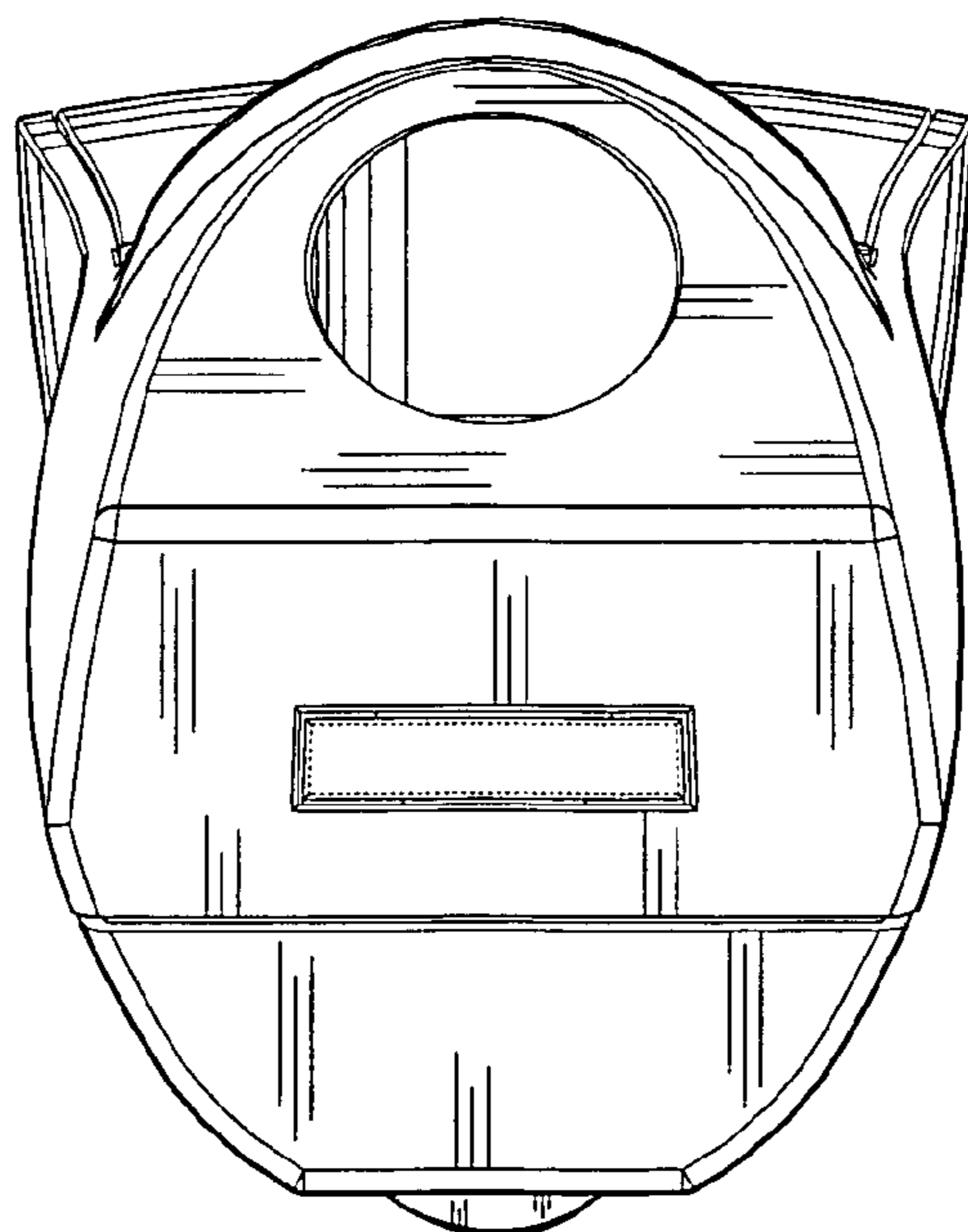
*Fig. 4*



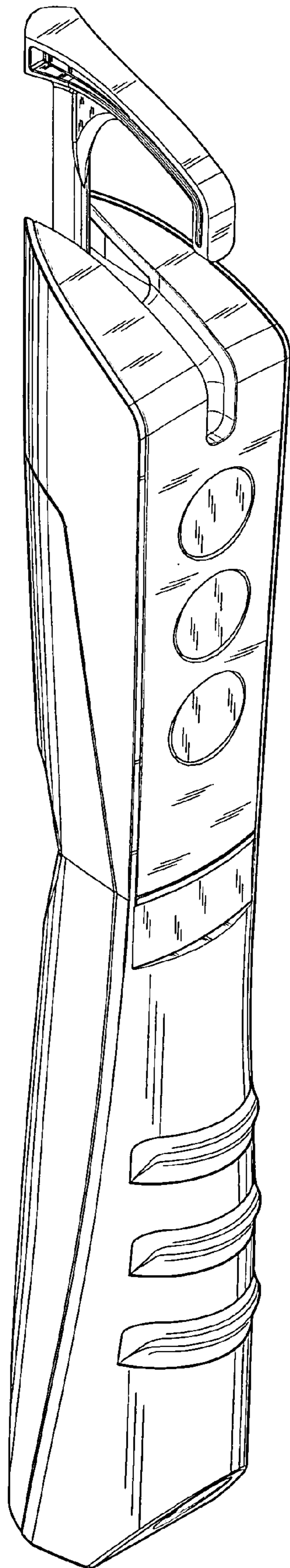
*Fig. 5*



*Fig. 6*

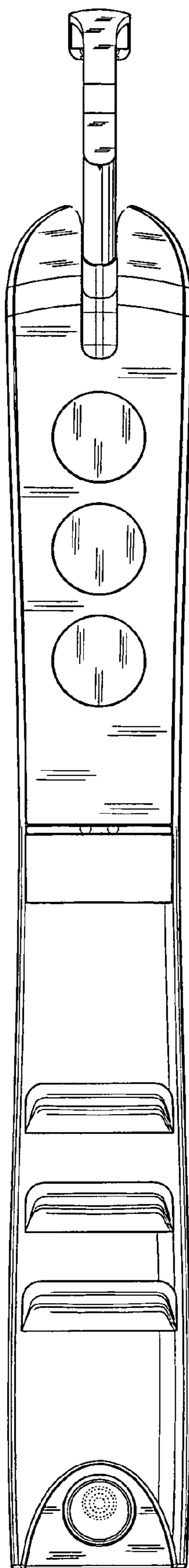


*Fig. 7*

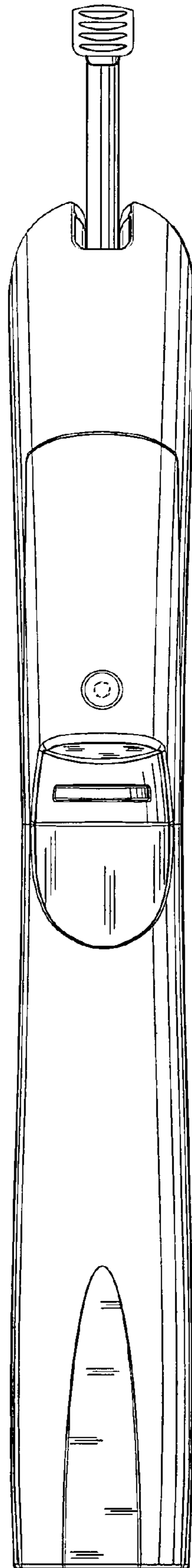


*Fig. 8*

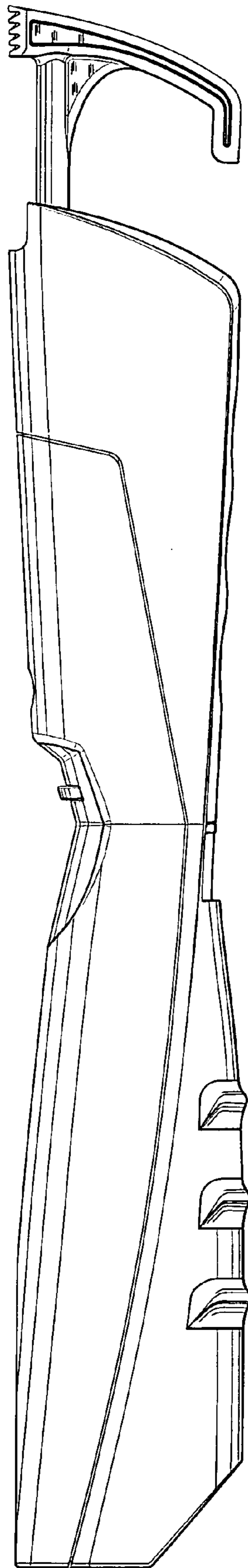




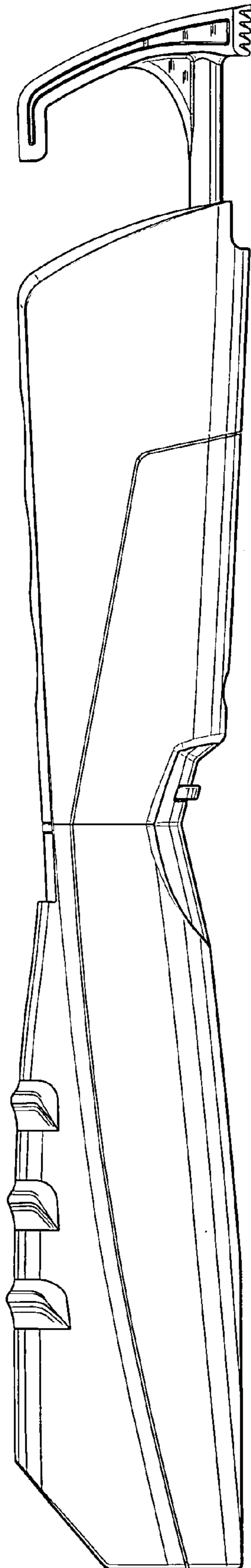
*Fig. 9*



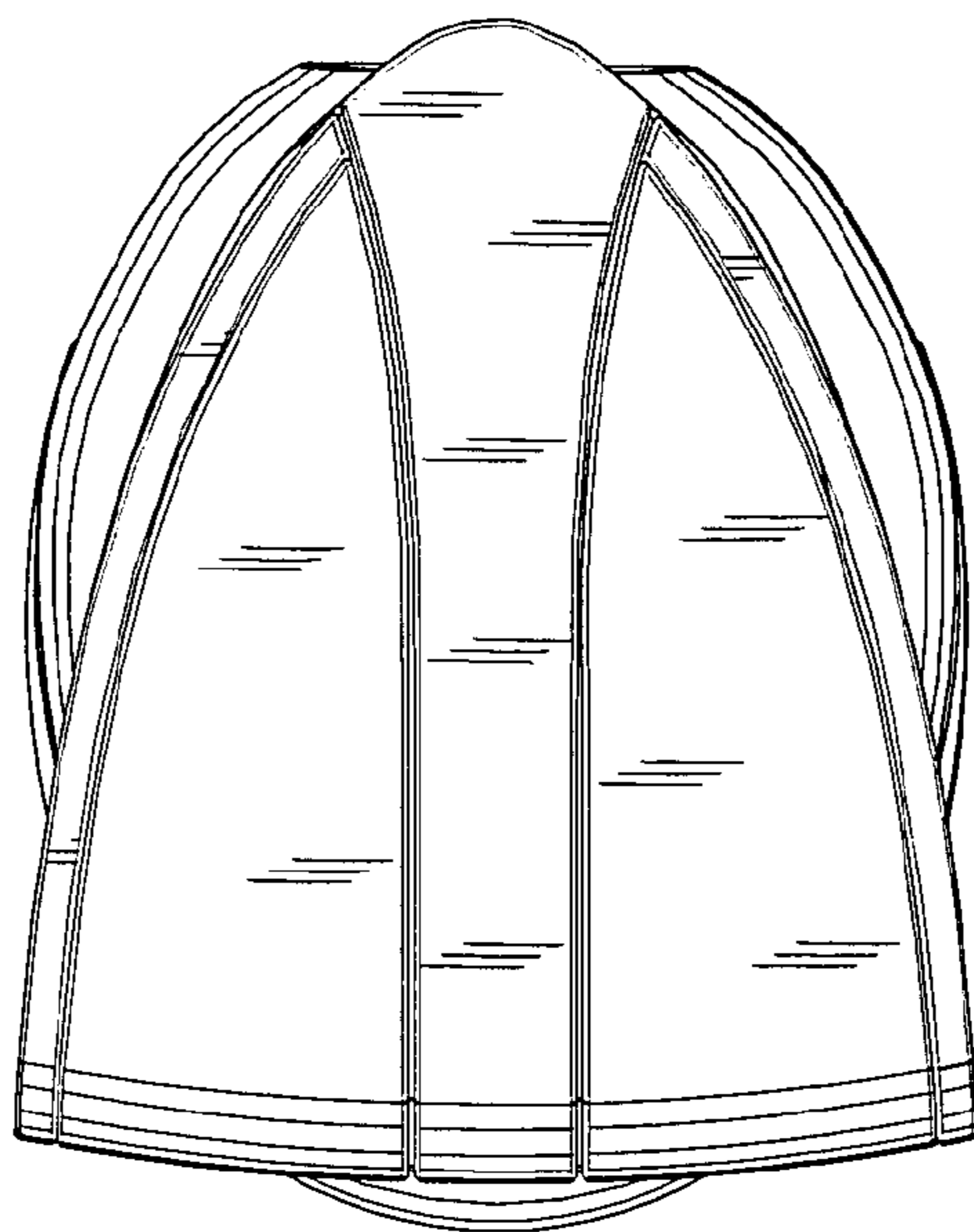
*Fig. 10*



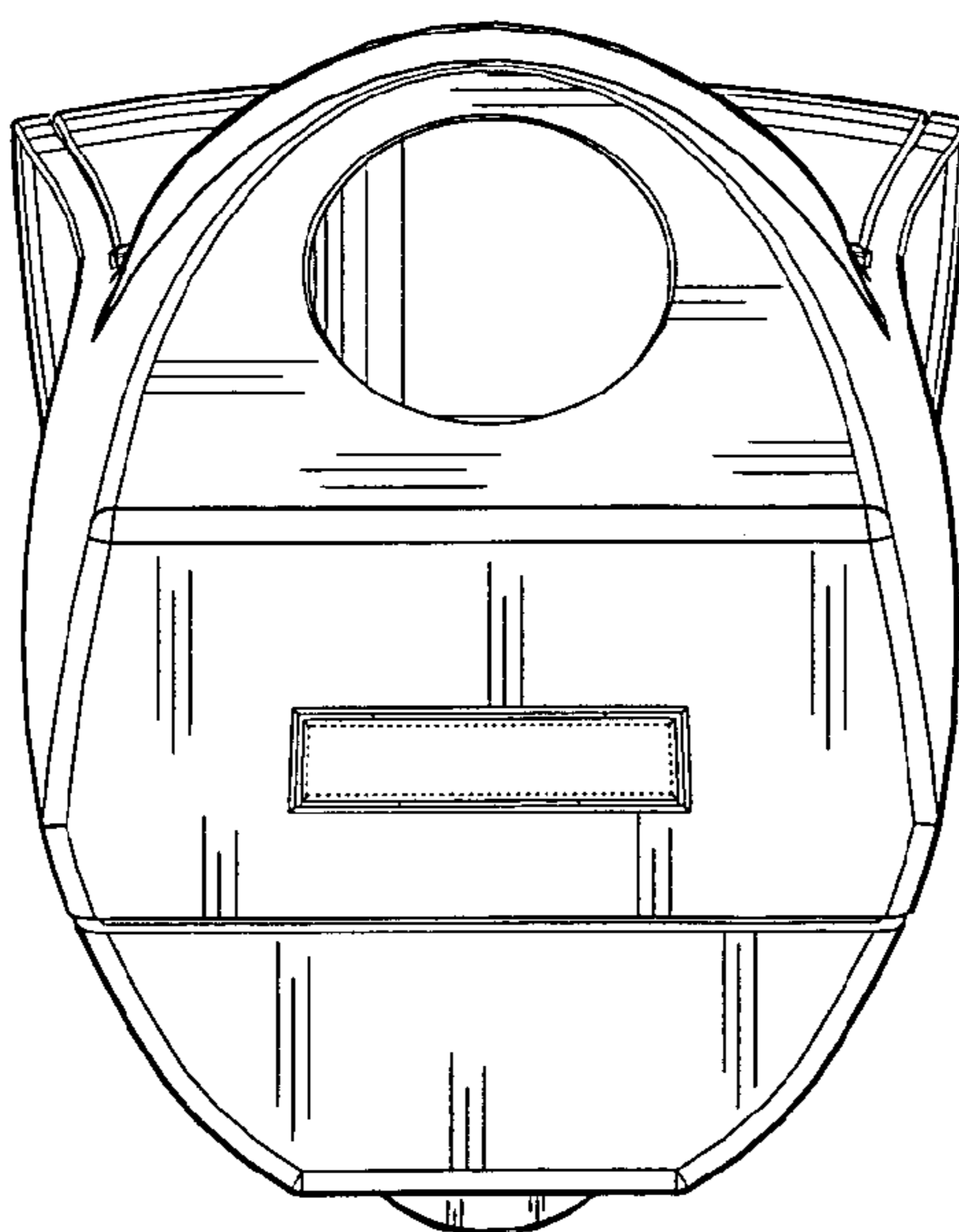
*Fig. 11*



*Fig. 12*



*Fig. 13*



*Fig. 14*