

US00D626601S

(12) **United States Design Patent**  
**Syring**

(10) **Patent No.:** **US D626,601 S**  
(45) **Date of Patent:** **\*\* Nov. 2, 2010**

(54) **VEHICLE, TOY, AND/OR OTHER REPLICAS**

(57) **CLAIM**

(75) Inventor: **Marcus Syring**, Munich (DE)

The ornamental design for a vehicle, toy, and/or other replicas, as shown and described.

(73) Assignee: **Bayerische Motoren Werke Aktiengesellschaft**, Munich (DE)

**DESCRIPTION**

(\*\*) Term: **14 Years**

This application contains subject matter related to the following pending U.S. design patent application:

(21) Appl. No.: **29/356,390**

Application Ser. No. 29/356,389, filed Feb. 25, 2010.

(22) Filed: **Feb. 25, 2010**

FIG. 1 is a left, front perspective view of a vehicle, toy, and/or other replicas according to my design, the right, front perspective view being mirror symmetrical;

(30) **Foreign Application Priority Data**

Aug. 26, 2009 (DE) ..... 402009004190

FIG. 2 is a left, rear perspective view thereof, the right, rear perspective view being mirror symmetrical;

(51) **LOC (9) Cl.** ..... **12-08**

FIG. 3 is a left side view thereof;

(52) **U.S. Cl.** ..... **D21/92**

FIG. 4 is a right side view thereof;

(58) **Field of Classification Search** ..... D12/86,  
D12/90-92, 88; D21/424, 433, 434; 296/181.1,  
296/181.5

FIG. 5 is a front view thereof;

See application file for complete search history.

FIG. 6 is a rear view thereof; and

(56) **References Cited**

**U.S. PATENT DOCUMENTS**

- D478,533 S \* 8/2003 Nicholas et al. .... D12/91
- D490,019 S \* 5/2004 Sakae ..... D12/91
- D504,087 S \* 4/2005 Hakamata et al. .... D12/91
- D513,716 S \* 1/2006 Acampora ..... D12/91
- D540,714 S \* 4/2007 Mueller-Stolz ..... D12/91
- D551,123 S \* 9/2007 Rabinowitz et al. .... D12/92
- D559,153 S \* 1/2008 Rabinowitz et al. .... D12/92
- D575,677 S \* 8/2008 Hildebrand et al. .... D12/91
- D614,535 S \* 4/2010 Park et al. .... D12/92

FIG. 7 is a top view thereof.

FIG. 8 is a left, front perspective view of a second embodiment of a vehicle, toy, and/or other replicas according to my design, the right, front perspective view being mirror symmetrical;

FIG. 9 is a left, rear perspective view of FIG. 7, the right, rear perspective view being mirror symmetrical;

FIG. 10 is a left side view of FIG. 7;

FIG. 11 is a right side view of FIG. 7;

FIG. 12 is a front view of FIG. 7;

FIG. 13 is a rear view thereof; and,

FIG. 14 is a top view thereof.

\* cited by examiner

The broken lines are for illustrative purposes only and form no part of the claimed design.

*Primary Examiner*—Melody N Brown  
(74) *Attorney, Agent, or Firm*—Crowell & Moring LLP

**1 Claim, 12 Drawing Sheets**

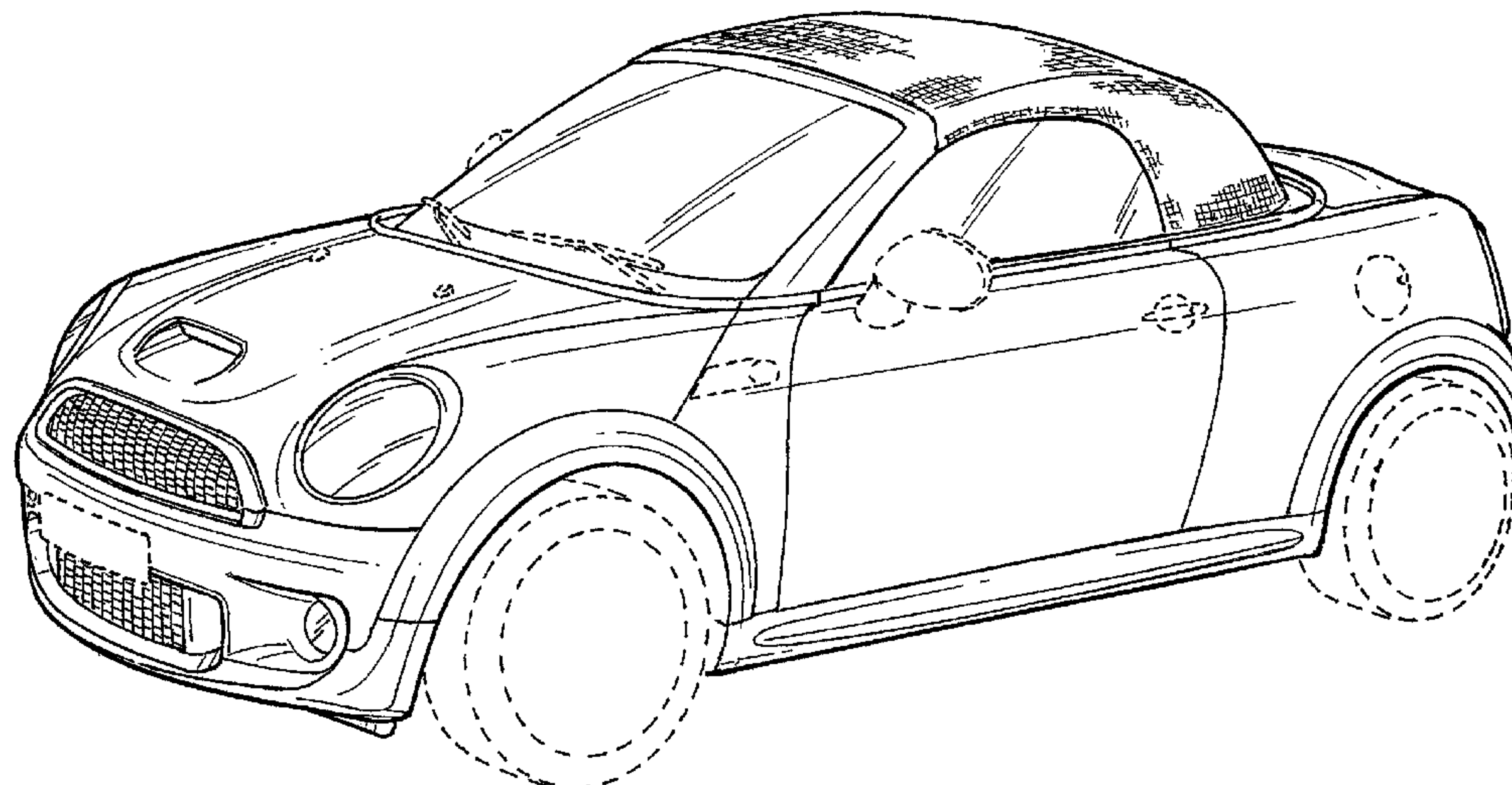

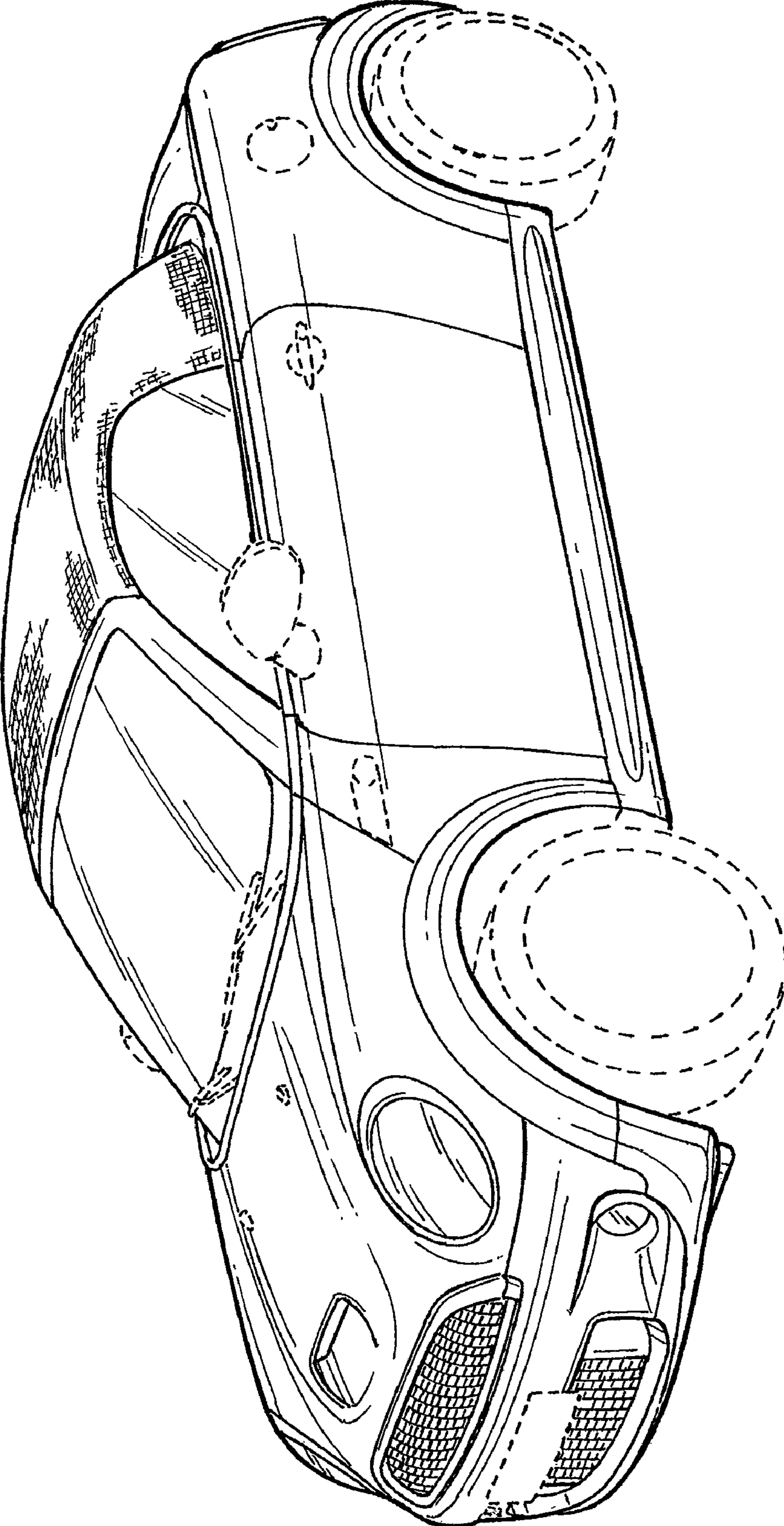

FIG. 1

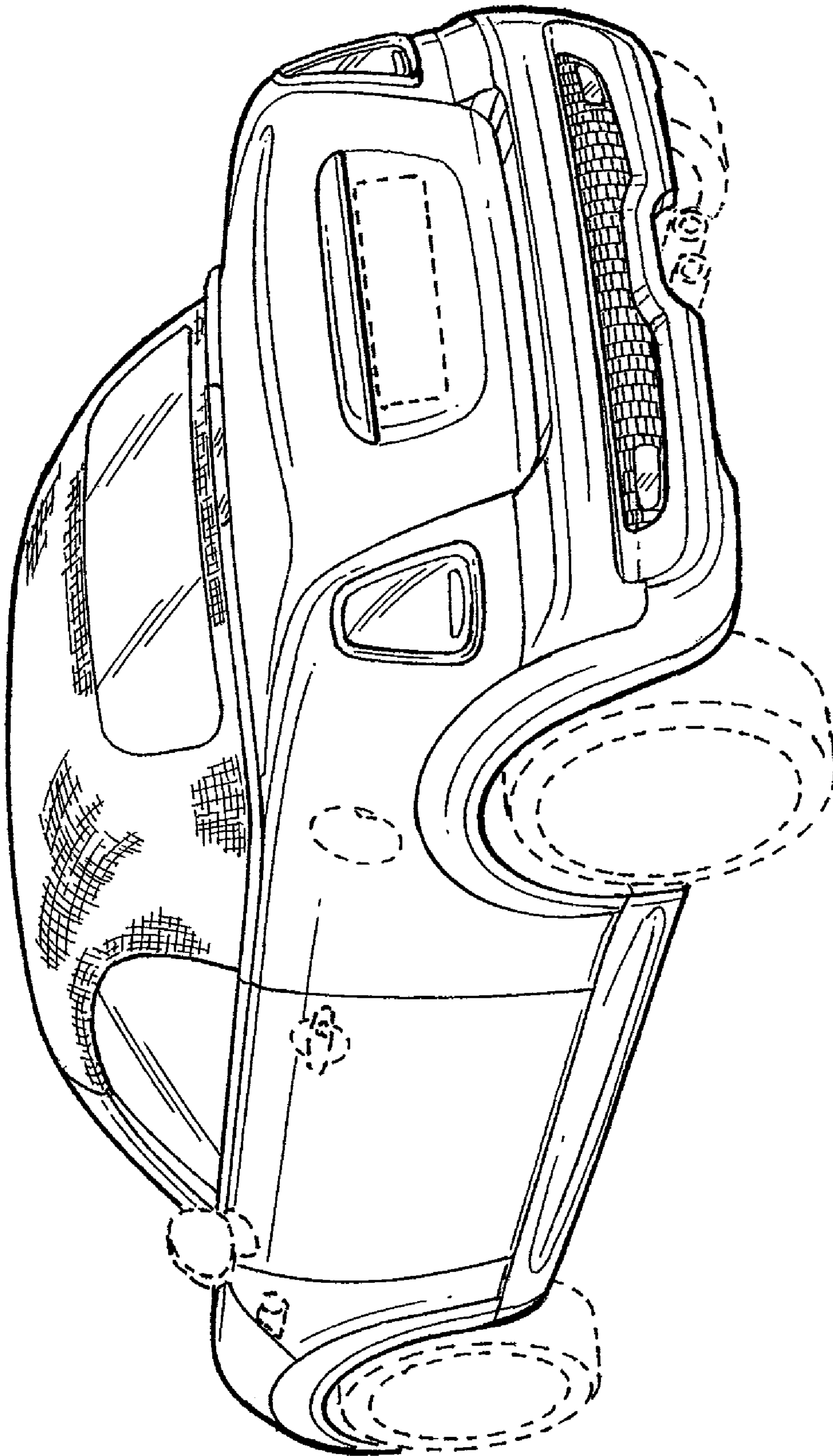

FIG. 2



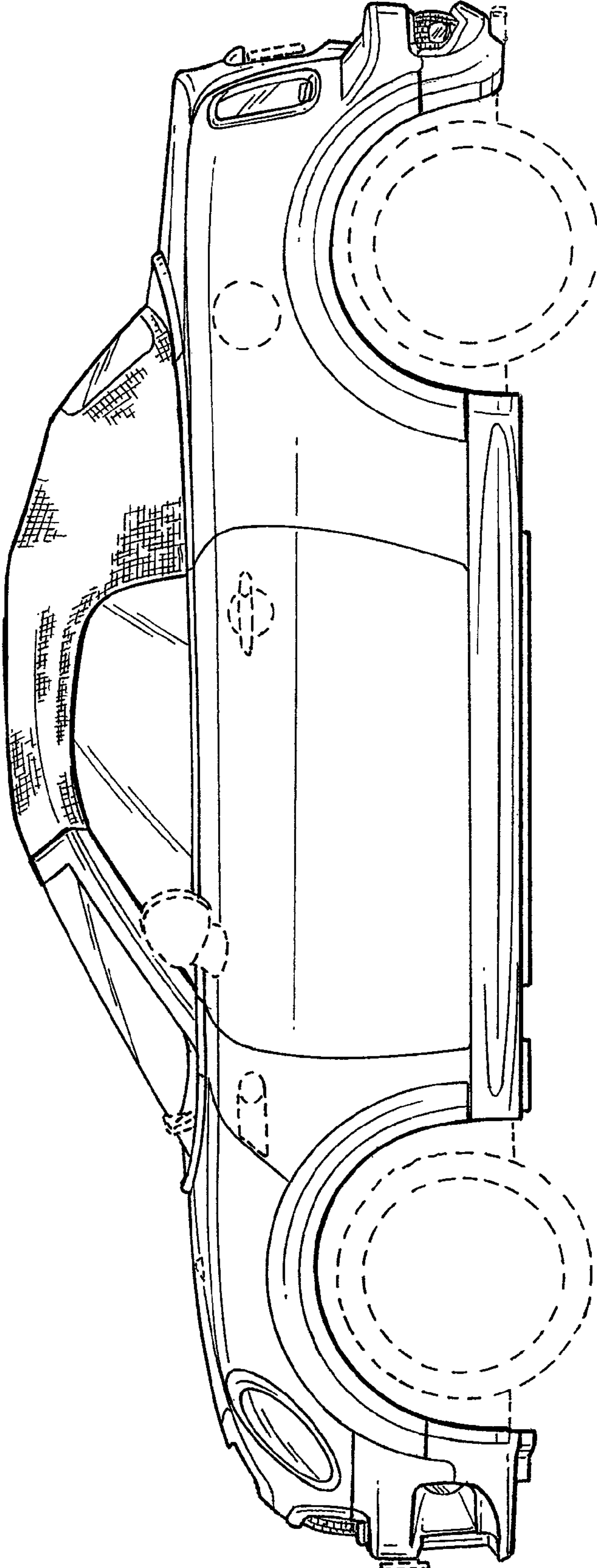

FIG. 3

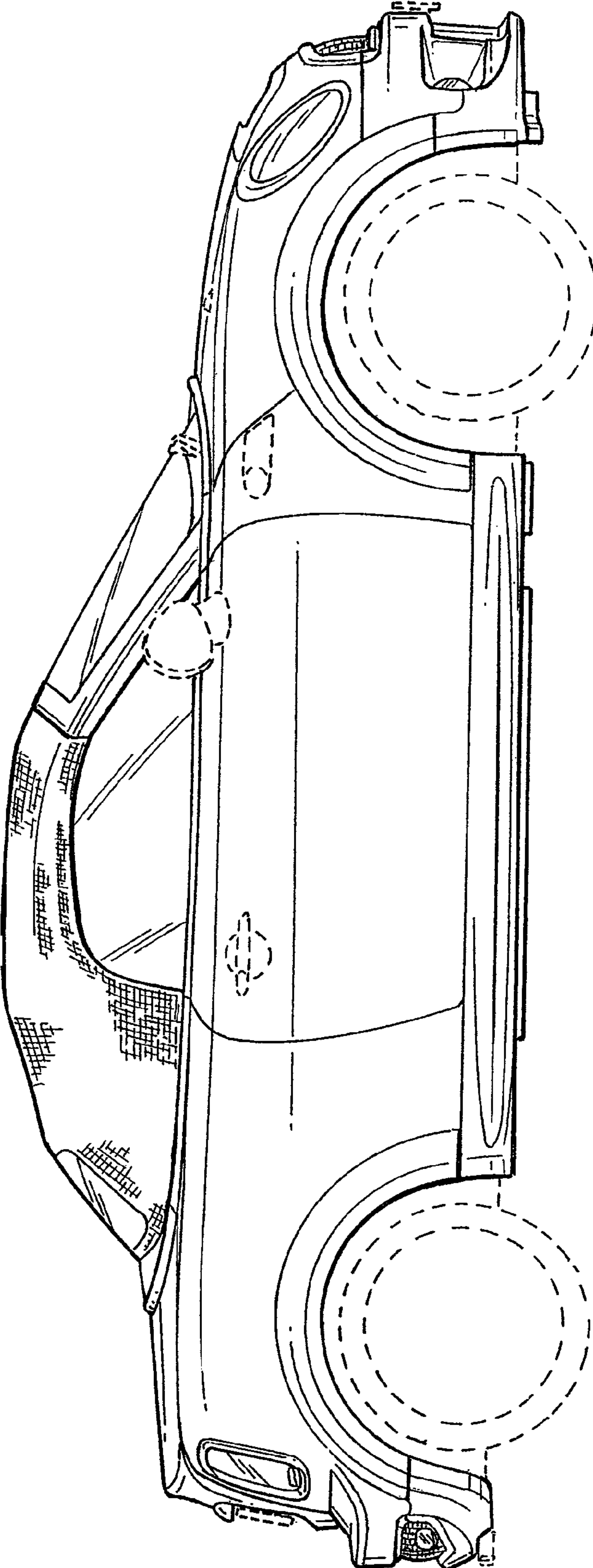

FIG. 4

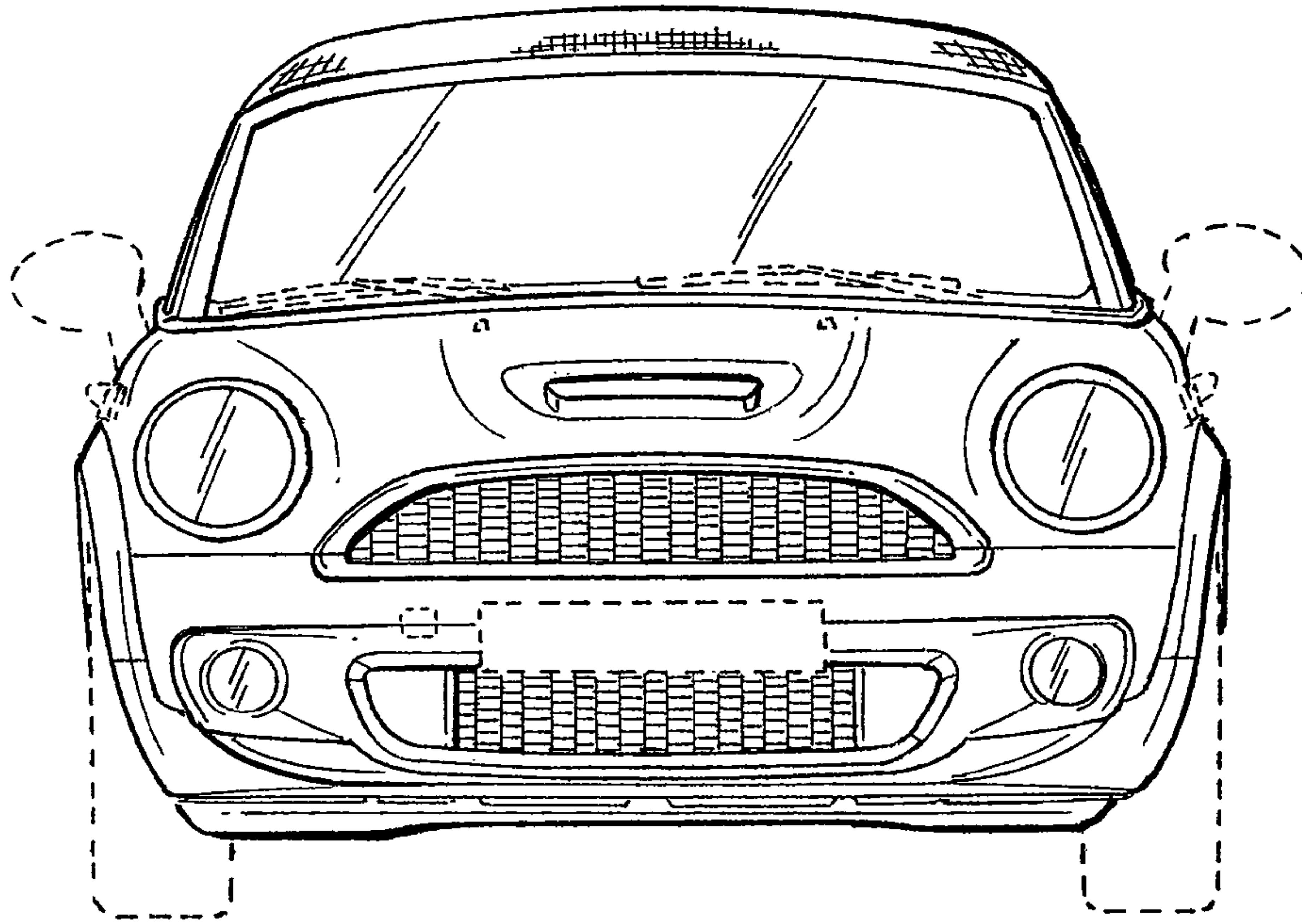

FIG. 5

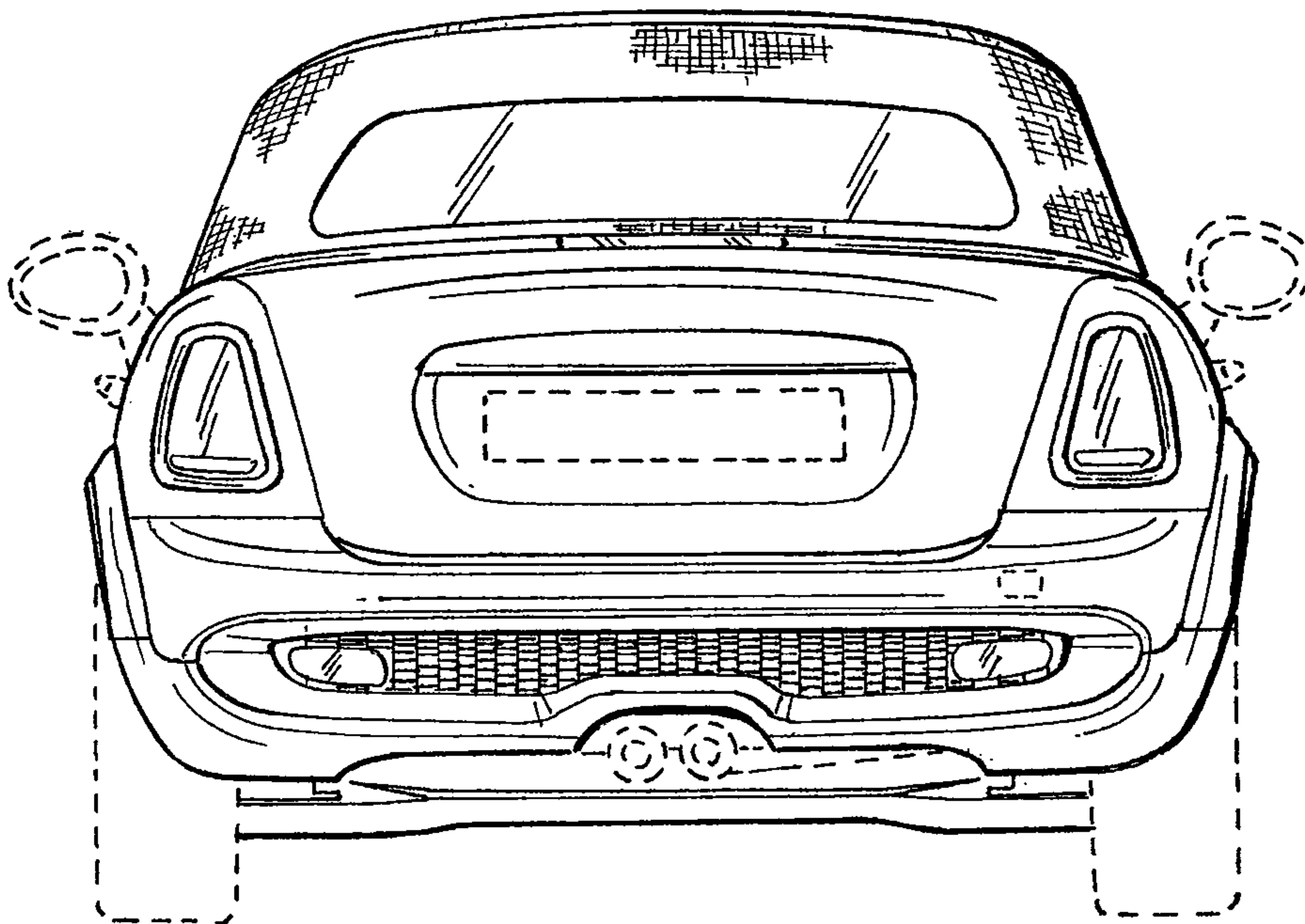

FIG. 6



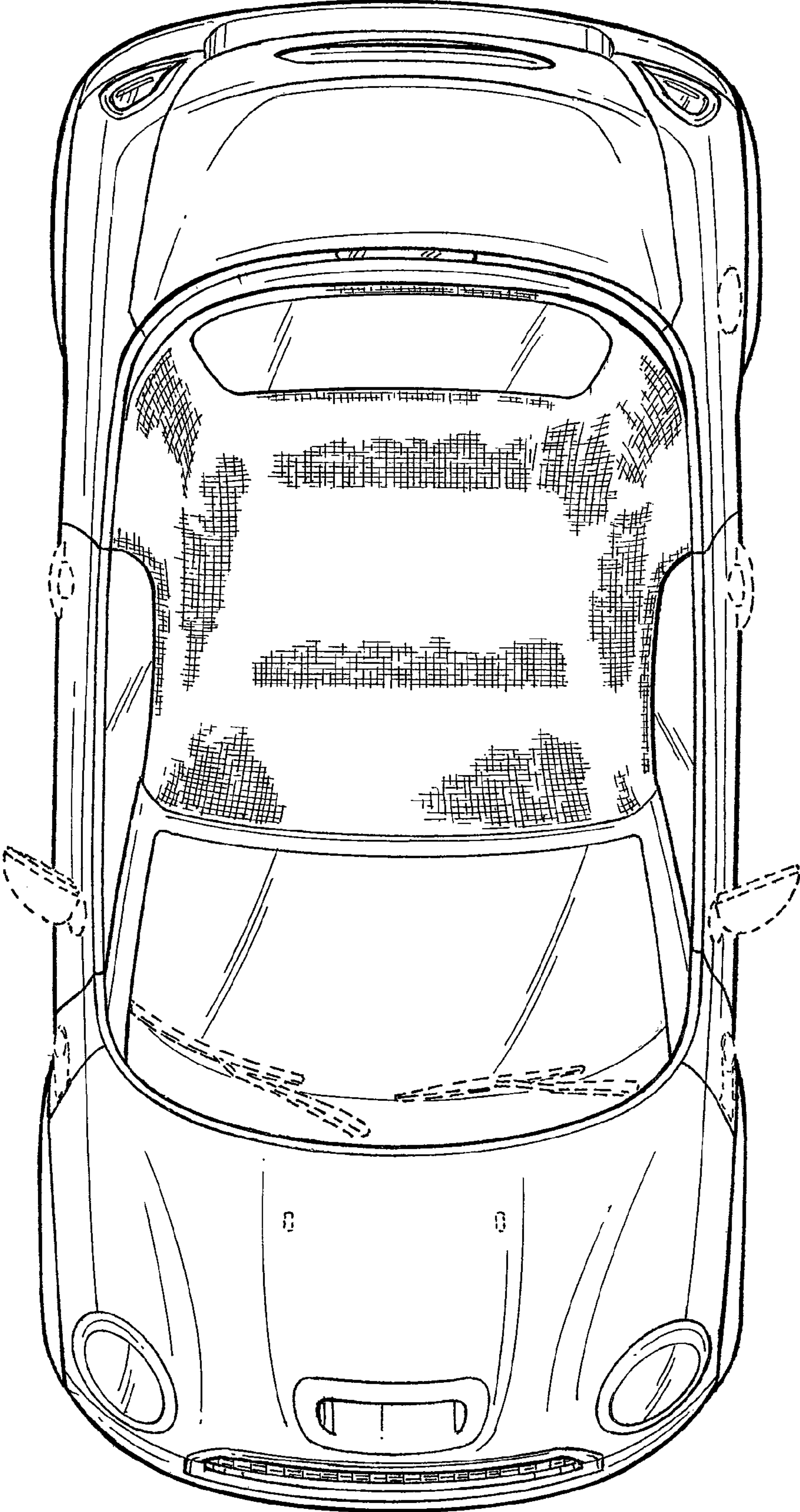

FIG. 7

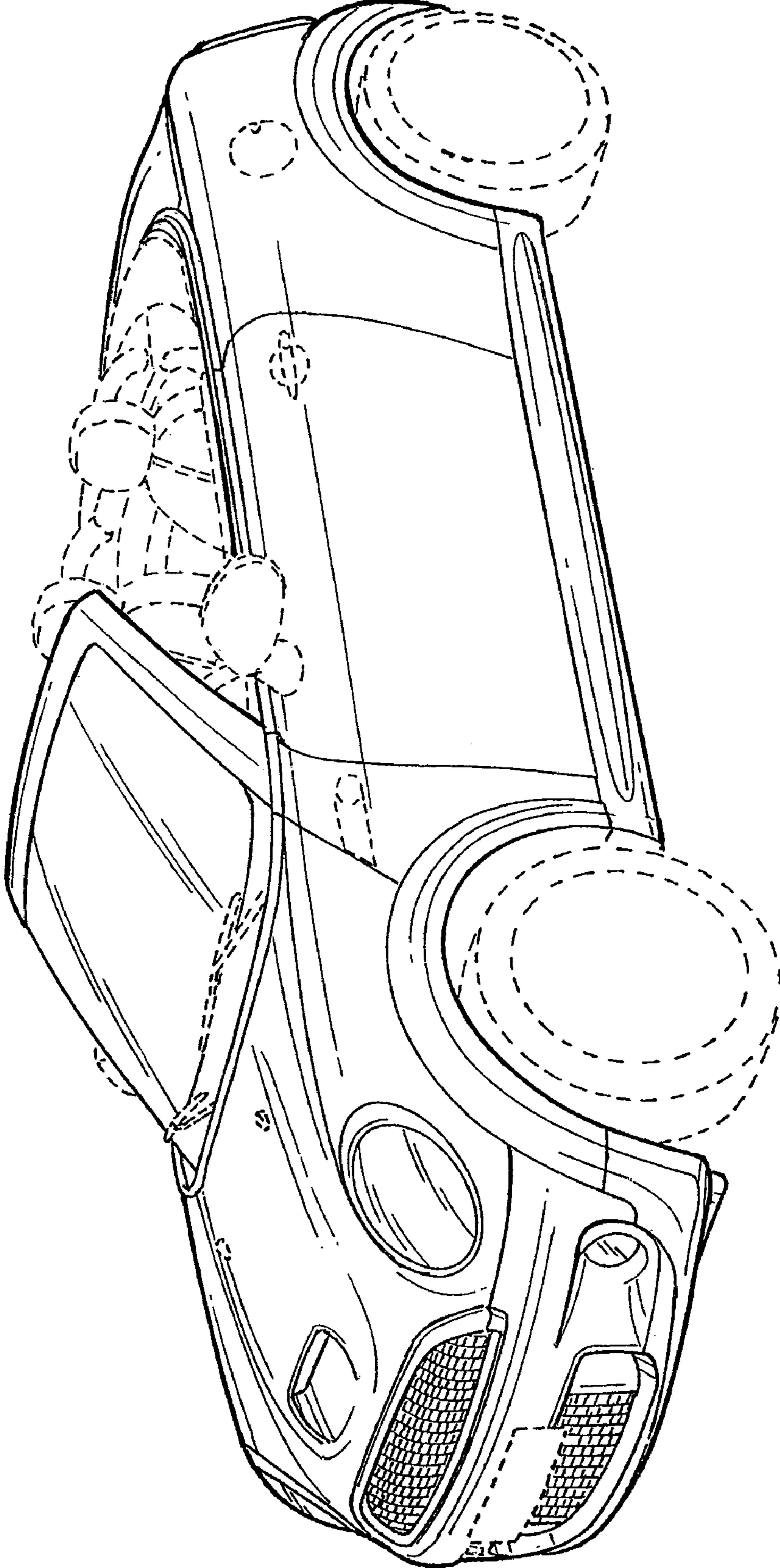

FIG. 8



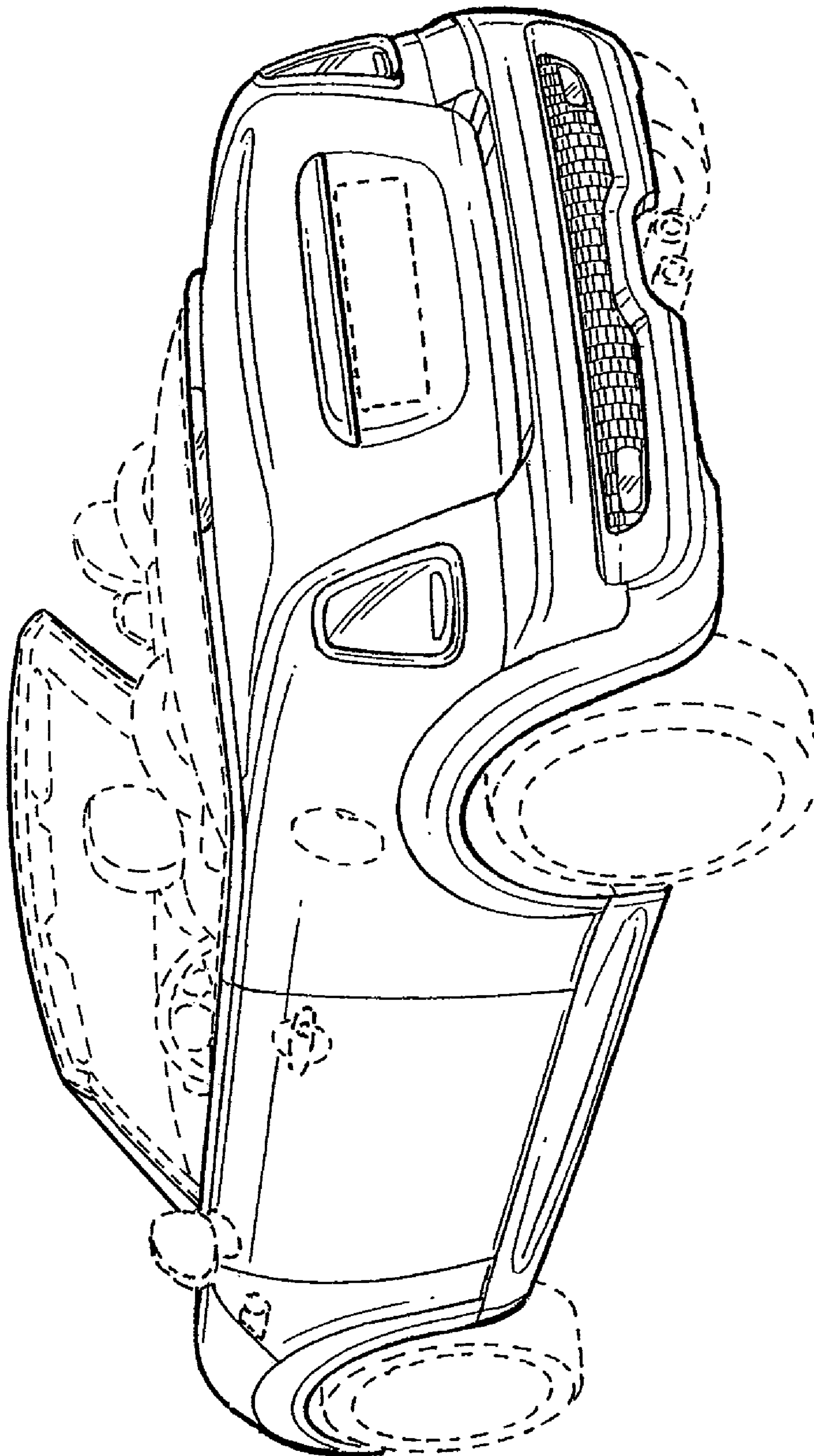

FIG. 9

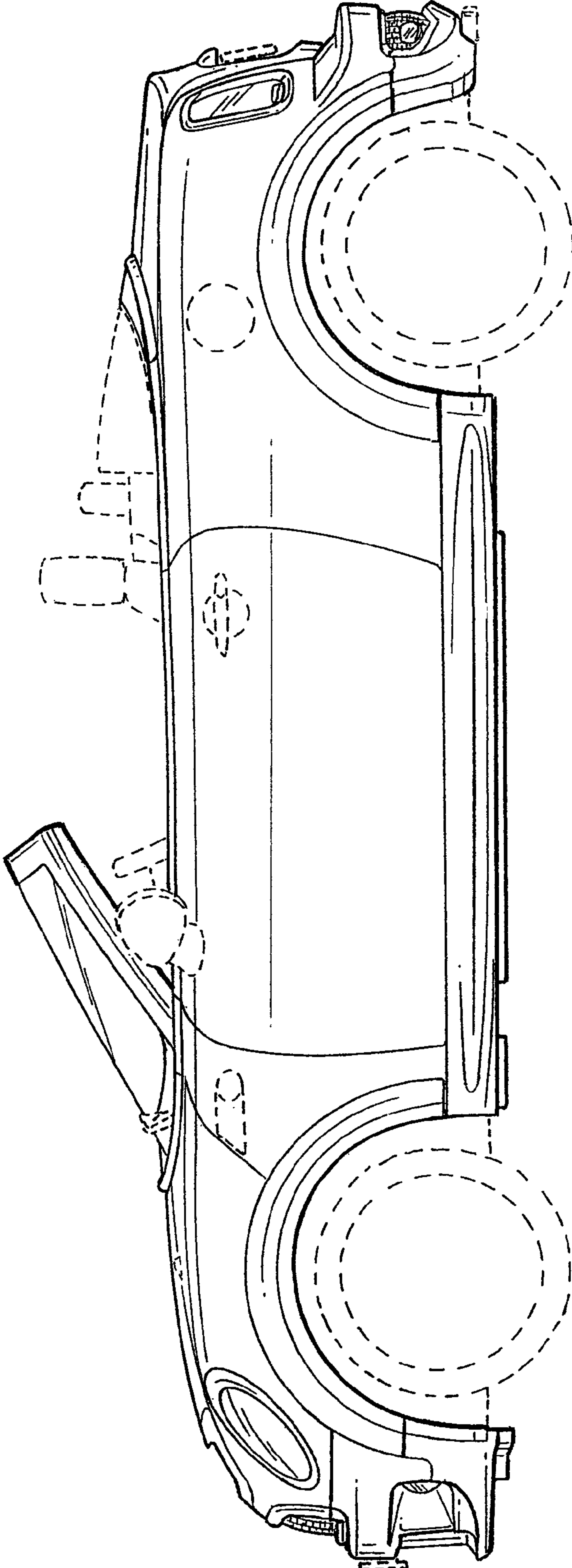

FIG. 10

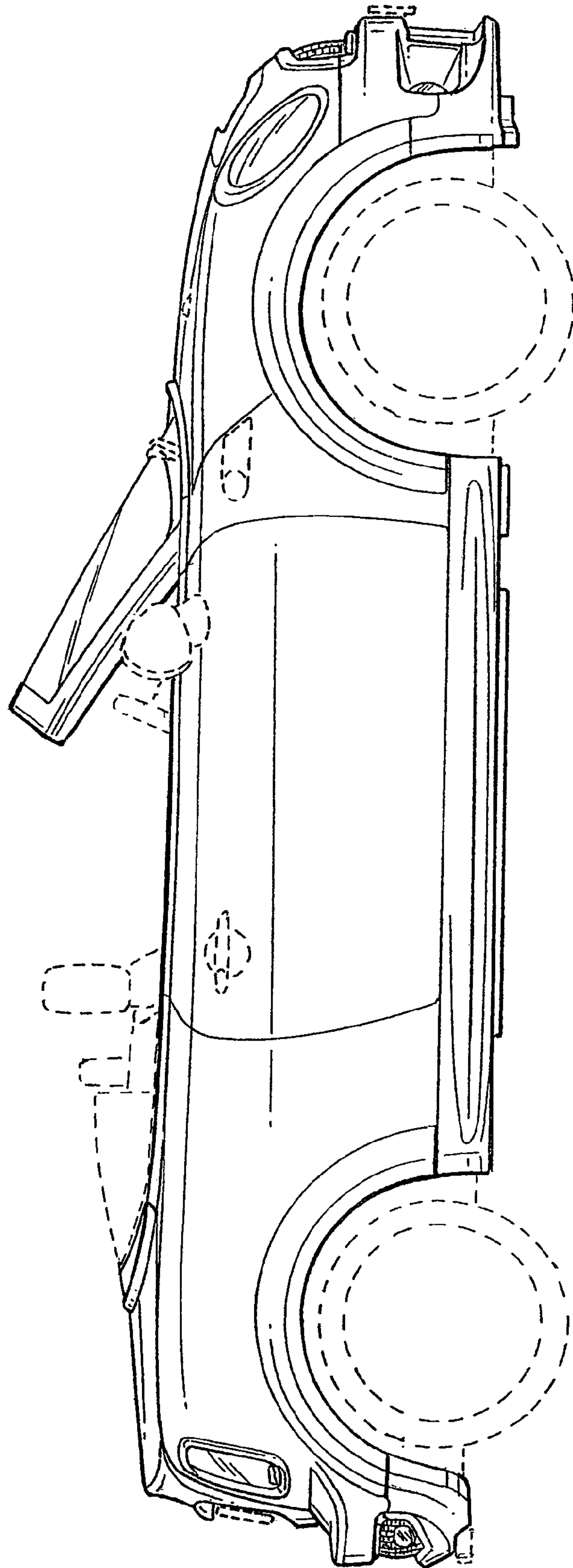

FIG. 11



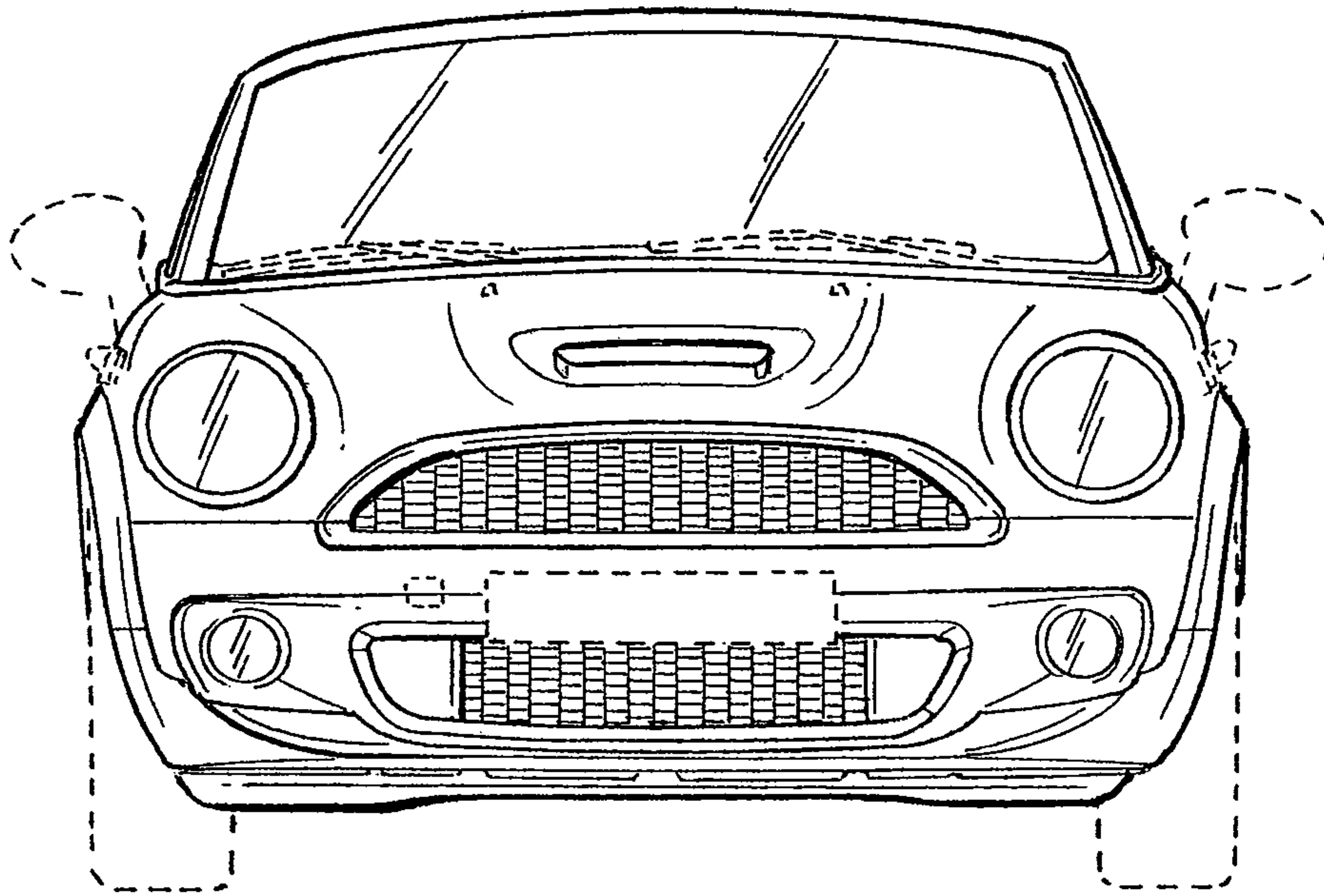

FIG. 12

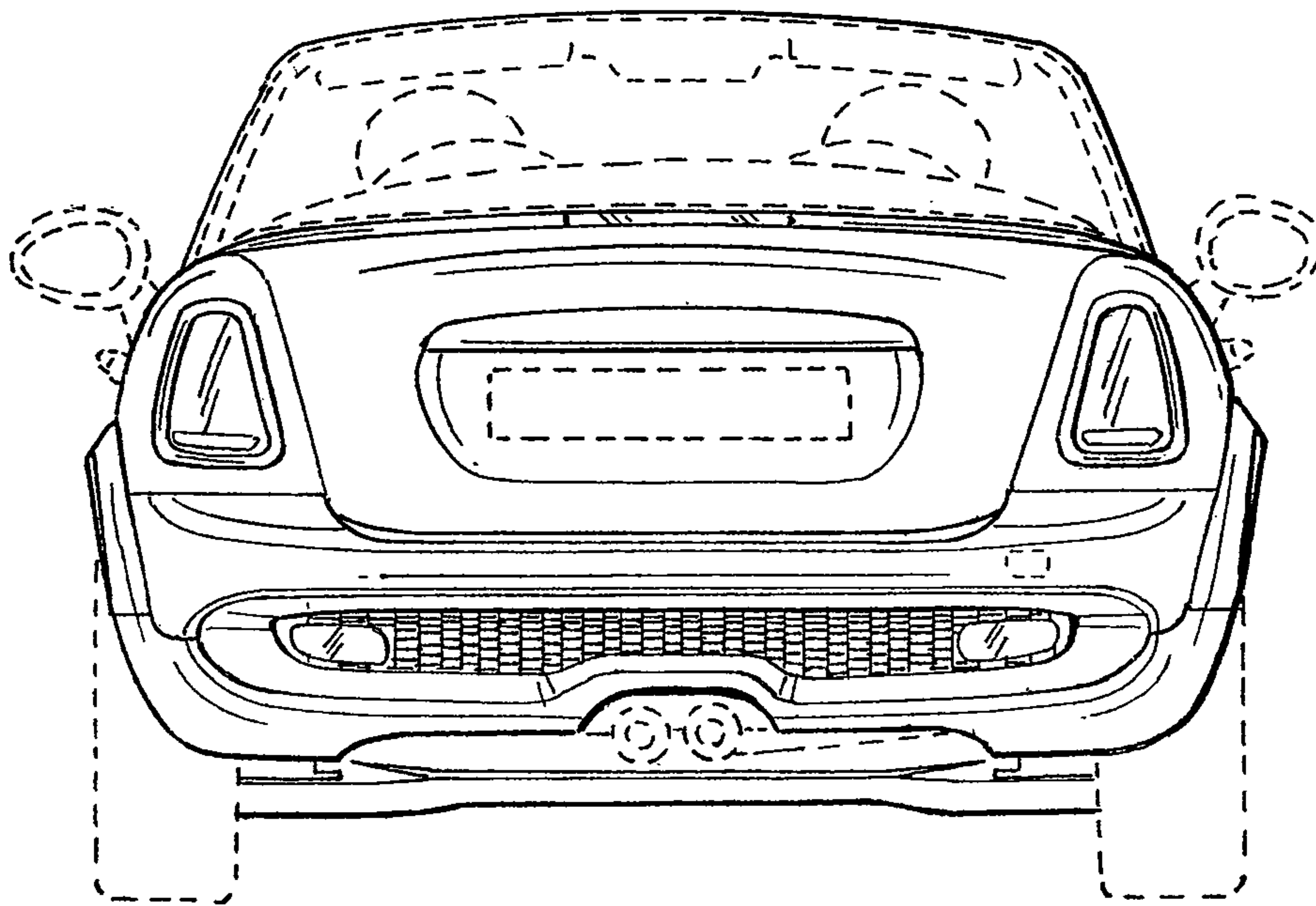

FIG. 13

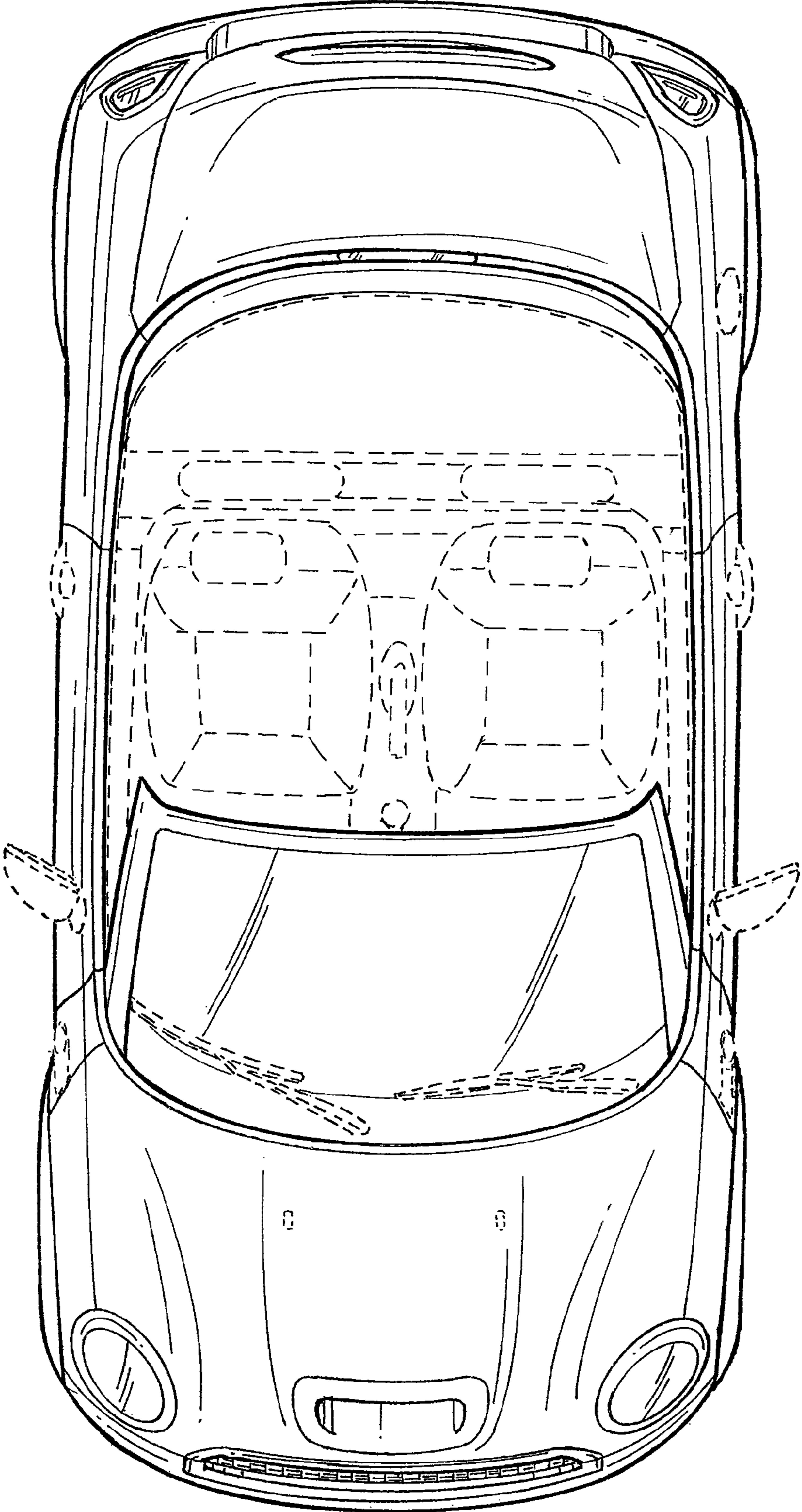

FIG. 14