



US00D626549S

(12) **United States Design Patent**
Chiu

(10) **Patent No.:** **US D626,549 S**

(45) **Date of Patent:** **** Nov. 2, 2010**

(54) **PORTABLE COMPUTING DEVICE**

(75) Inventor: **Kumo Chiu**, Beijing (CN)

(73) Assignee: **Marvell International Ltd.**, Hamilton (BM)

(**) Term: **14 Years**

(21) Appl. No.: **29/330,340**

(22) Filed: **Jan. 5, 2009**

(51) **LOC (9) Cl.** **14-02**

(52) **U.S. Cl.** **D14/341**

(58) **Field of Classification Search** D14/331,
D14/336, 341-346, 371-374, 129; D18/1,
D18/2, 7, 11; D19/59, 60; 341/22, 23; 345/156,
345/168, 169-173, 901-905; 349/12; 361/679.01,
361/679.58; 434/307 R, 308, 309, 317
See application file for complete search history.

(56) **References Cited**

U.S. PATENT DOCUMENTS

D392,259 S *	3/1998	Simmon	D14/341
D404,761 S *	1/1999	Tarpenning et al.	D14/341
D466,500 S *	12/2002	Lo et al.	D14/336
6,757,156 B2 *	6/2004	Adams et al.	361/679.03
6,781,824 B2 *	8/2004	Krieger et al.	361/679.58
D496,034 S *	9/2004	Guerrera et al.	D14/336
D514,098 S *	1/2006	Huang et al.	D14/315
D514,558 S *	2/2006	Nagel et al.	D14/341
D524,308 S *	7/2006	Lai	D14/346

D556,161 S *	11/2007	Hsiung	D14/129
D561,137 S *	2/2008	Hsiung	D14/129
2004/0228076 A1 *	11/2004	Clapper	361/681
2006/0038795 A1 *	2/2006	Lee	345/173

* cited by examiner

Primary Examiner—Freda S Nunn

(57) **CLAIM**

The ornamental design for portable computing device, as shown and described.

DESCRIPTION

FIG. 1 illustrates a top view of an ornamental design of a portable computing device in accordance with embodiments of the present invention;

FIG. 2 illustrates a bottom view thereof;

FIG. 3 illustrates a front view thereof;

FIG. 4 illustrates a back view thereof;

FIG. 5 illustrates a side view thereof;

FIG. 6 illustrates an opposite side view thereof;

FIG. 7 illustrates a top view of a second embodiment thereof;

FIG. 8 illustrates a bottom view thereof;

FIG. 9 illustrates a front view thereof;

FIG. 10 illustrates a back view thereof;

FIG. 11 illustrates a side view thereof; and,

FIG. 12 illustrates an opposite side view thereof.

1 Claim, 2 Drawing Sheets

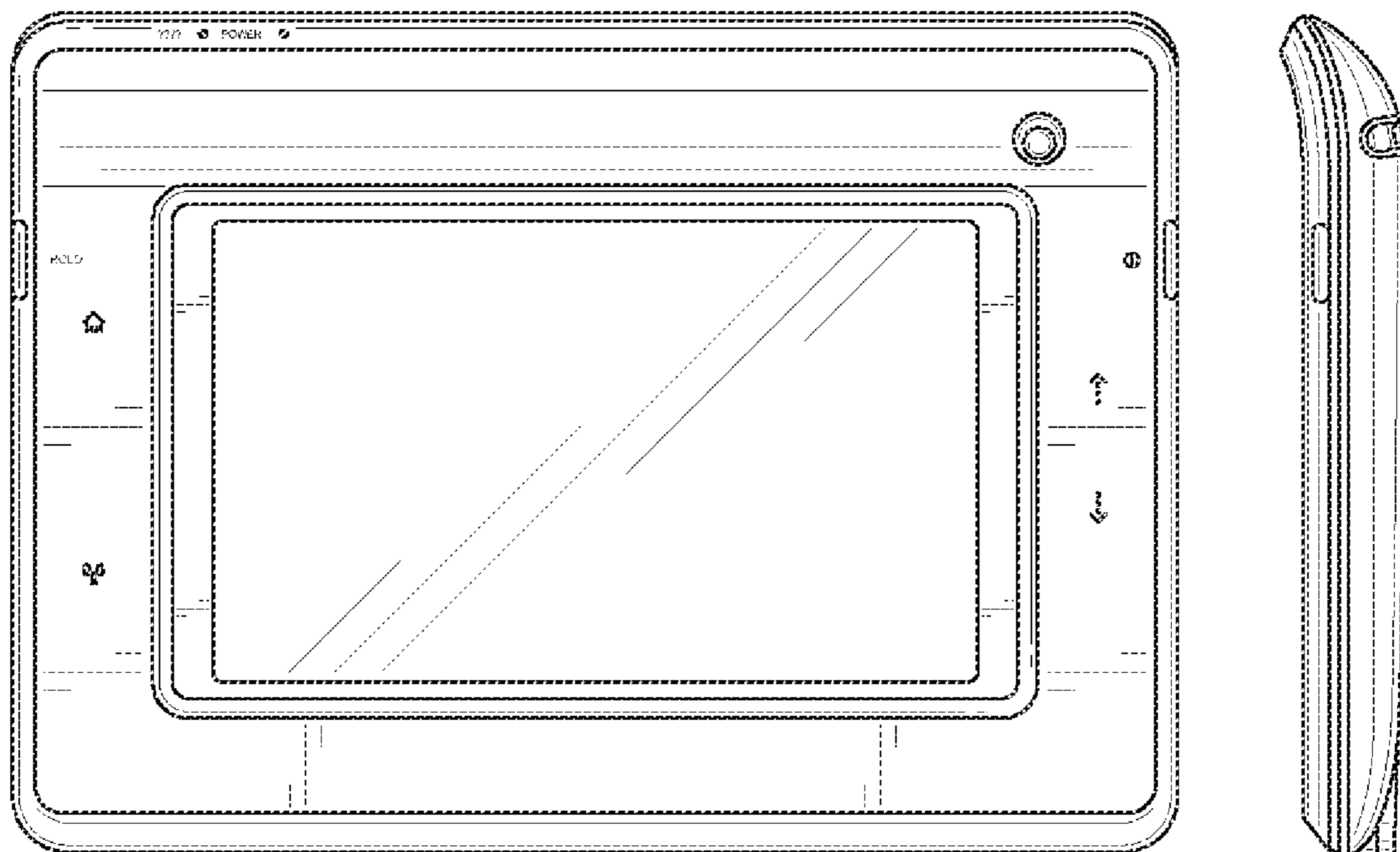

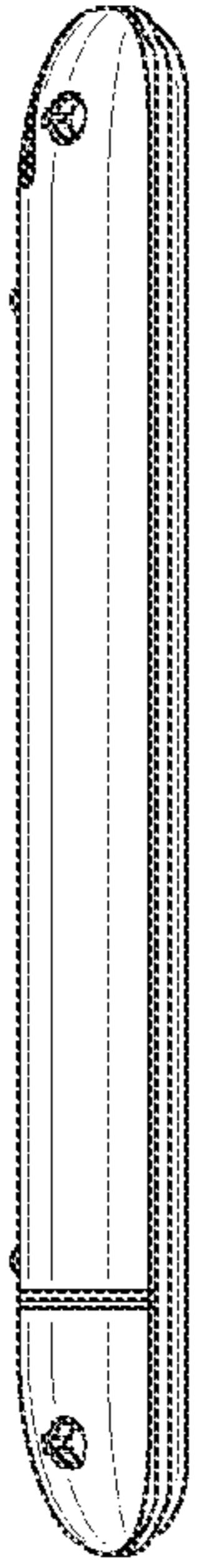

FIG. 4

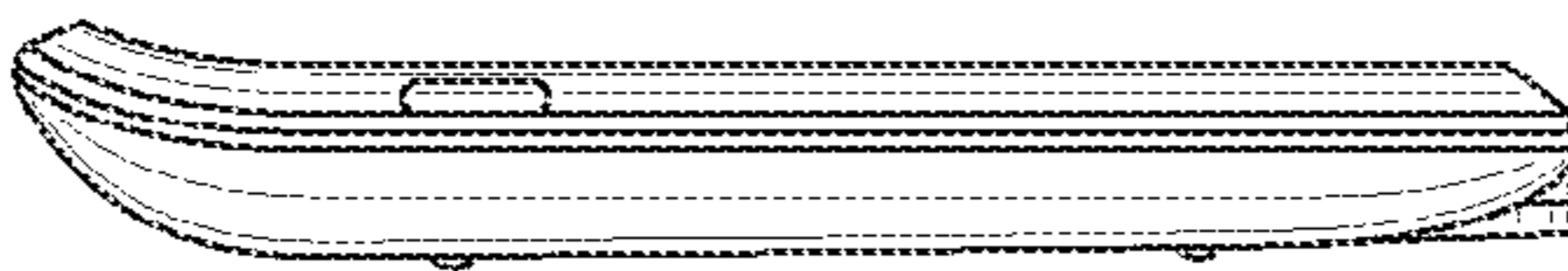

FIG. 5

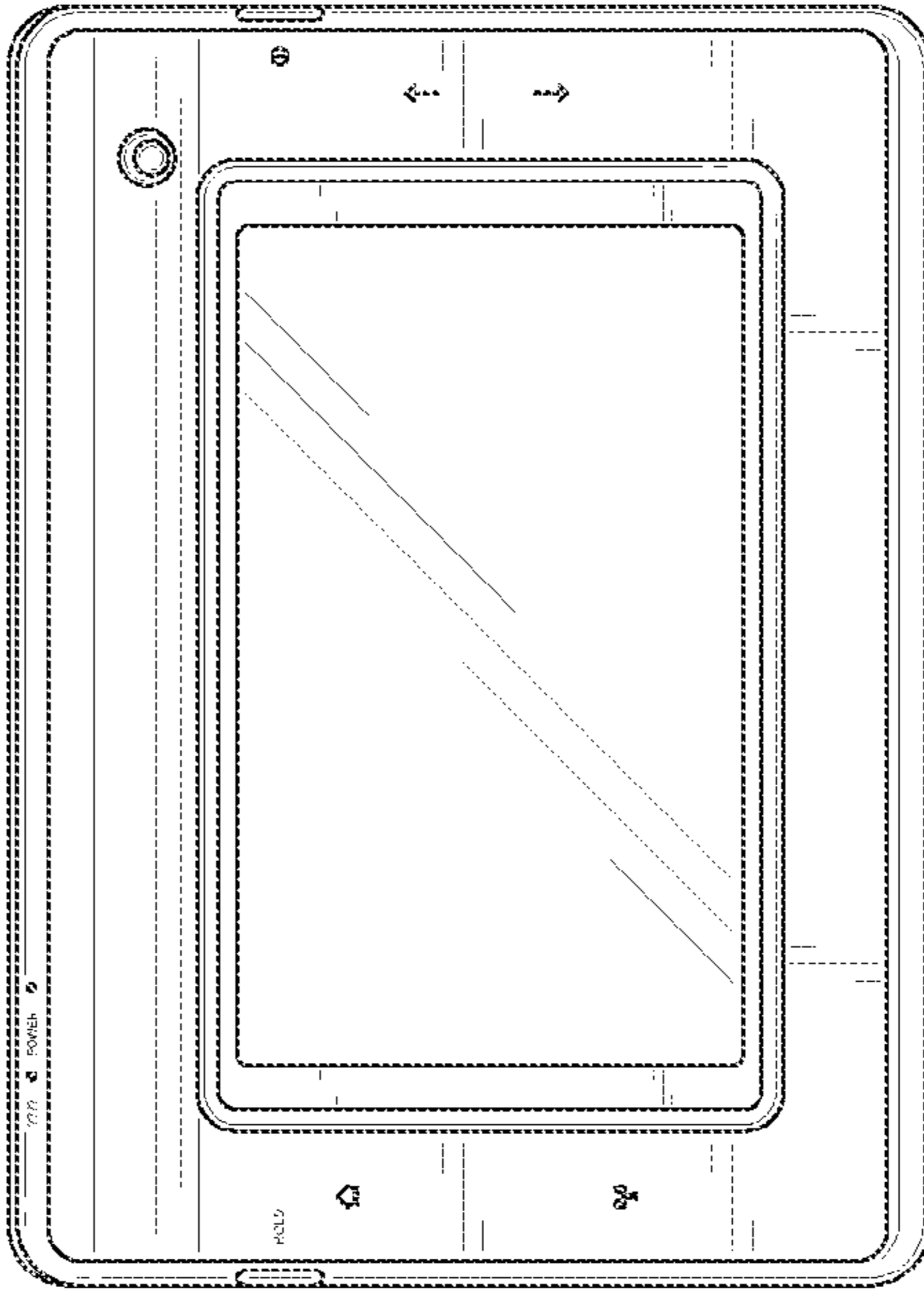

FIG. 1

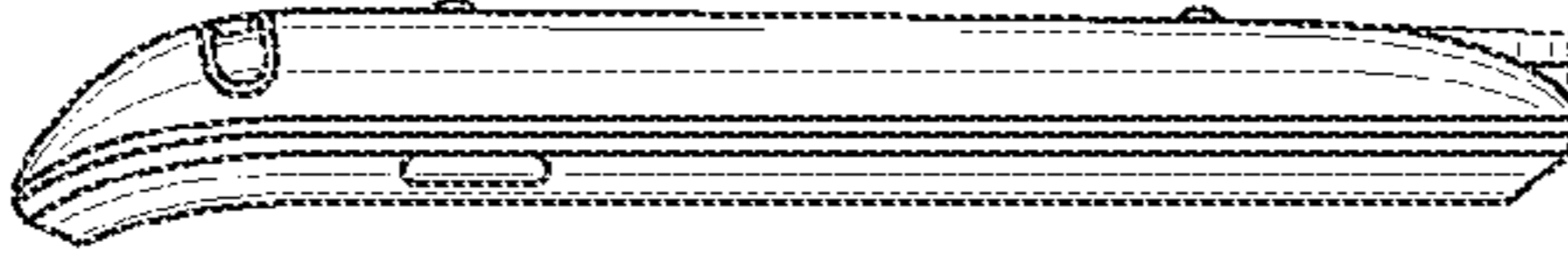

FIG. 6

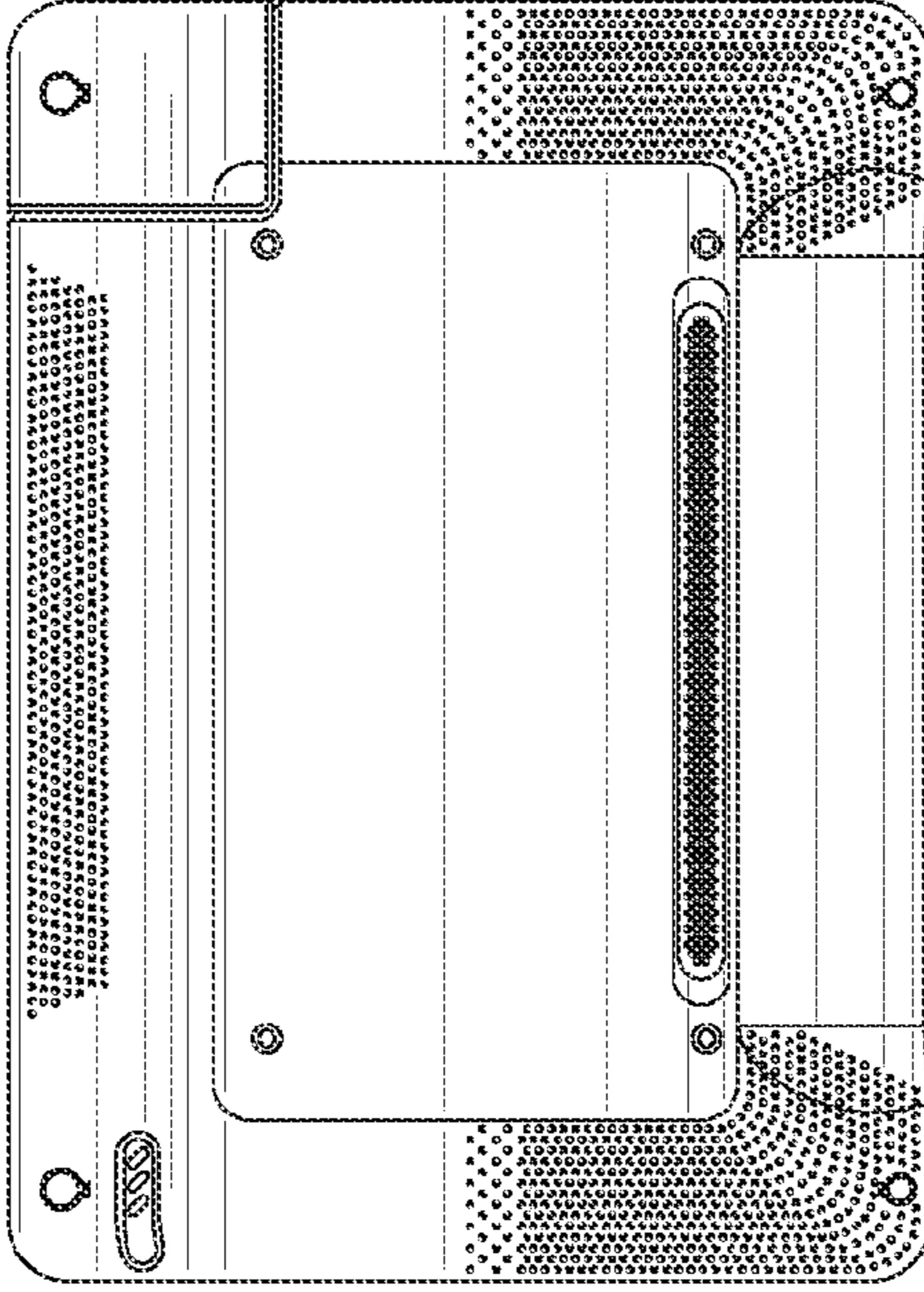

FIG. 2

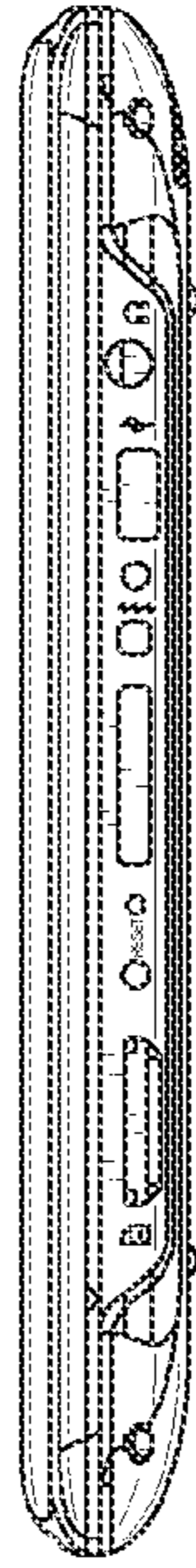

FIG. 3

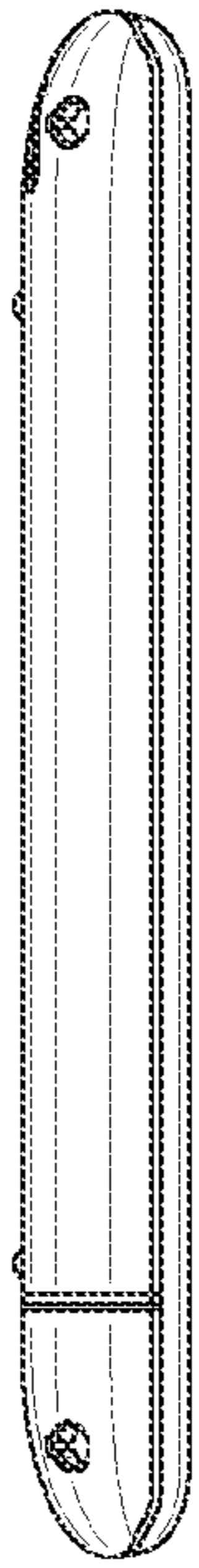

FIG. 10

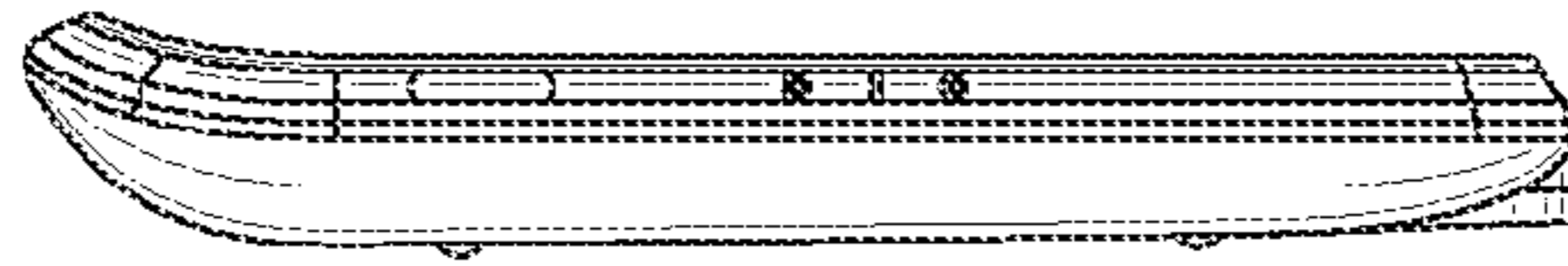

FIG. 11

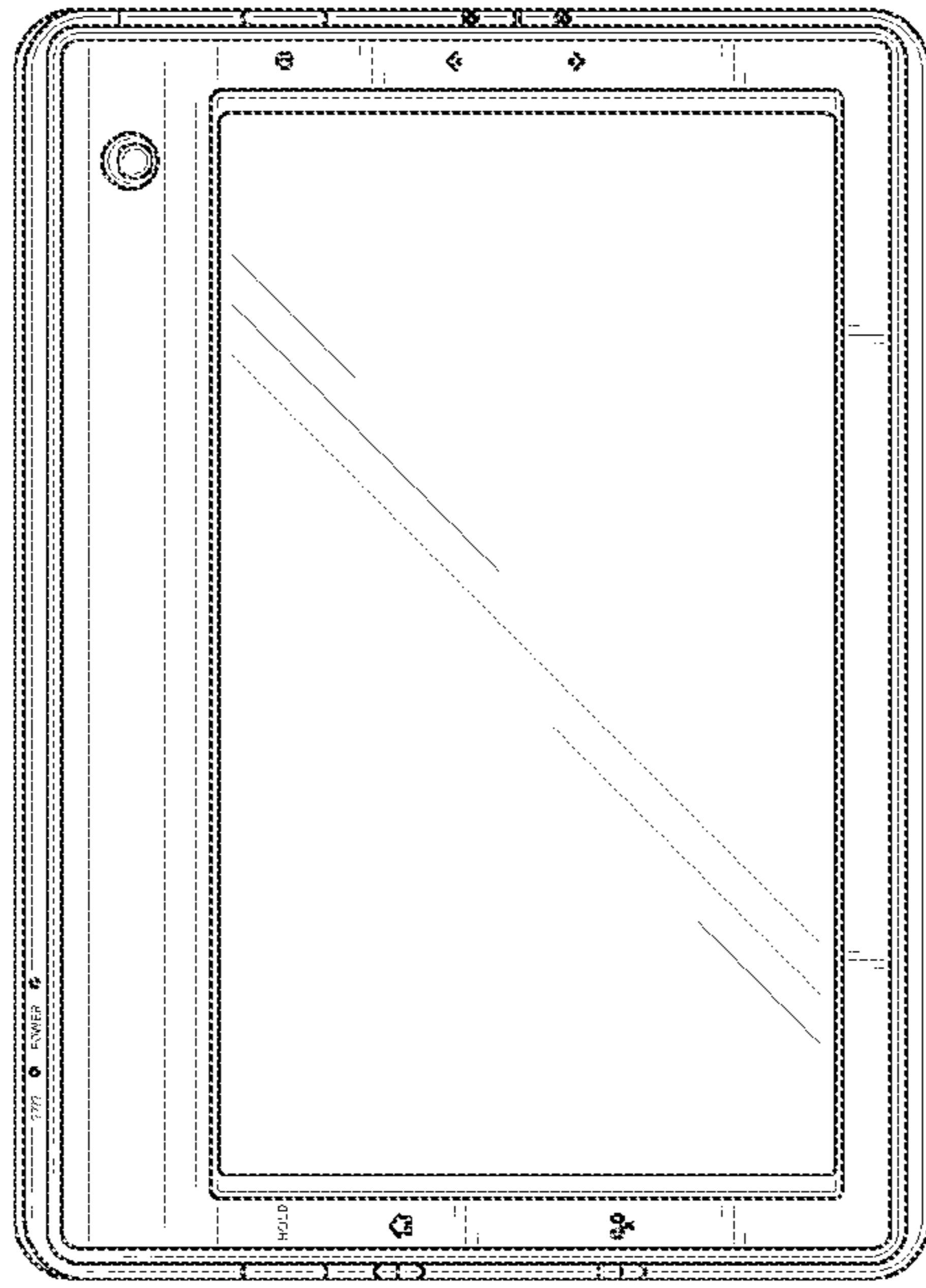

FIG. 7

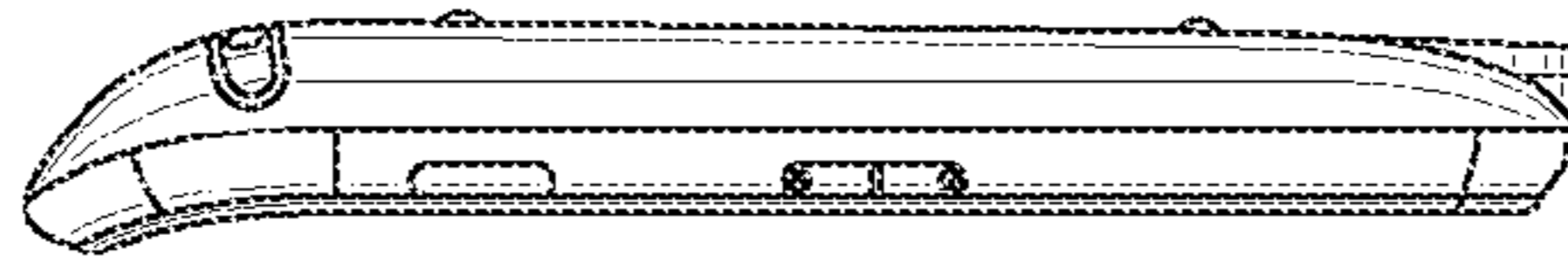

FIG. 12

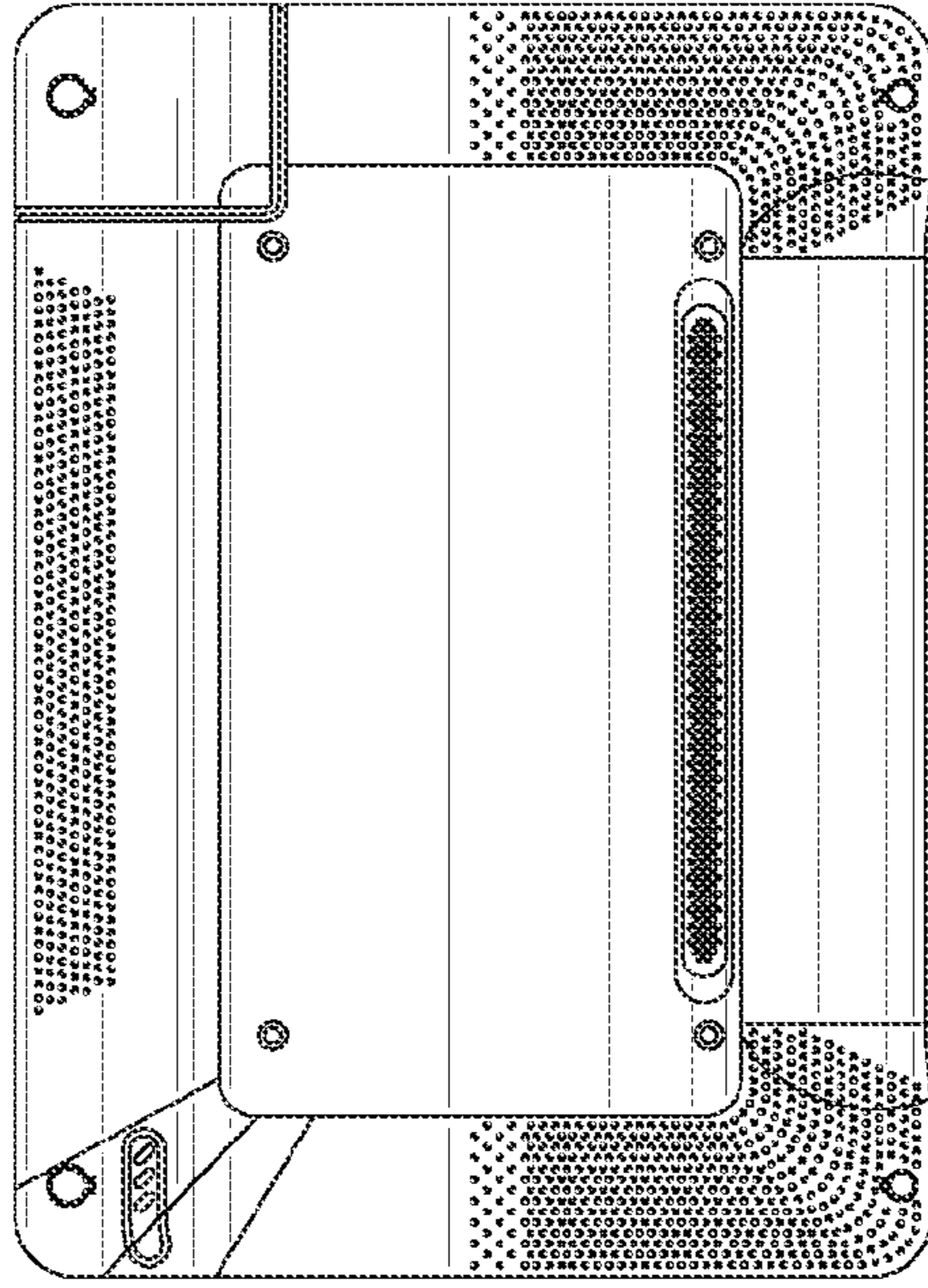

FIG. 8

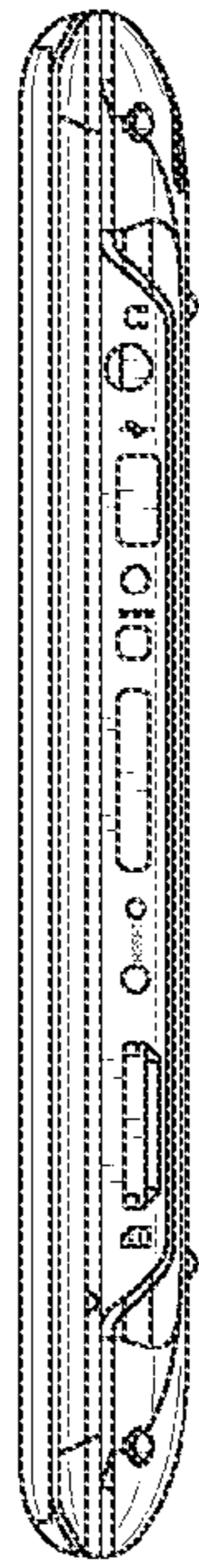

FIG. 9