



US00D626528S

(12) **United States Design Patent**
Park et al.

(10) **Patent No.:** **US D626,528 S**
(45) **Date of Patent:** **** Nov. 2, 2010**

(54) **MOBILE PHONE**

(75) Inventors: **Hyoung-Shin Park**, Seoul (KR);
Sang-Min Hyun, Seoul (KR); **Jong-Bo Jung**, Seoul (KR)

(73) Assignee: **Samsung Electronics Co., Ltd.** (KR)

(**) Term: **14 Years**

(21) Appl. No.: **29/356,480**

(22) Filed: **Feb. 26, 2010**

(30) **Foreign Application Priority Data**

Jan. 8, 2010 (KR) 30-2010-0000617

(51) **LOC (9) Cl.** **14-03**

(52) **U.S. Cl.** **D14/138 AB**

(58) **Field of Classification Search** D14/138 AB,
D14/496, 341, 345, 346, 203.3, 203.4, 203.7;
455/575.3; D21/517; 379/433.13
See application file for complete search history.

(56) **References Cited**

U.S. PATENT DOCUMENTS

- D168,240 S * 11/1952 Rodriguez D11/24
- D217,280 S * 4/1970 Poon D11/21
- 3,657,059 A * 4/1972 Figge 428/110
- D358,149 S * 5/1995 Fellingner D14/138 AB
- D476,303 S * 6/2003 Lee et al. D14/138 AB
- D488,452 S * 4/2004 Chung D14/138 AB
- D507,551 S * 7/2005 Kim et al. D14/138 AB
- D536,320 S * 2/2007 Michaels D14/138 AB
- D546,309 S * 7/2007 Lee D14/138 AB
- D562,295 S * 2/2008 Lindner et al. D14/138 AB
- D572,127 S * 7/2008 O'Rourke et al. D14/138 AB
- D580,900 S * 11/2008 Wong et al. D14/138 AA
- D588,564 S * 3/2009 Pegon et al. D14/138 AA
- D588,571 S * 3/2009 Yasuda D14/138 AB

- D589,485 S * 3/2009 He D14/138 AB
- D589,486 S * 3/2009 He D14/138 AB
- D594,005 S * 6/2009 Shi et al. D14/341

(Continued)

OTHER PUBLICATIONS

Alcatel OT-V570 telephone, announced 2008, [online], [site visited Jun. 18, 2010]. Available from Internet, <URL: <http://www.gsmarena.com>>.*

(Continued)

Primary Examiner—Jeffrey D Asch
(74) *Attorney, Agent, or Firm*—NSIP Law

(57) **CLAIM**

The ornamental design for a mobile phone, as shown and described.

DESCRIPTION

FIG. 1 is a perspective view of a mobile phone;
FIG. 2 is a front view of the mobile phone of FIG. 1;
FIG. 3 is a rear view of the mobile phone of FIG. 1;
FIG. 4 is a left-side view of the mobile phone of FIG. 1;
FIG. 5 is a right-side view of the mobile phone of FIG. 1;
FIG. 6 is a top plan view of the mobile phone of FIG. 1;
FIG. 7 is a bottom plan view of the mobile phone of FIG. 1;
and,
FIG. 8 is an open view of the mobile phone of FIG. 1.

The broken lines shown in FIG. 8, which are immediately adjacent to the shaded areas and define an unshaded region, represent the bounds of the claimed design, while the other broken lines, all within the boundary, are directed to environment and are for illustrative purposes only; the broken lines form no part of the claimed design.

1 Claim, 6 Drawing Sheets

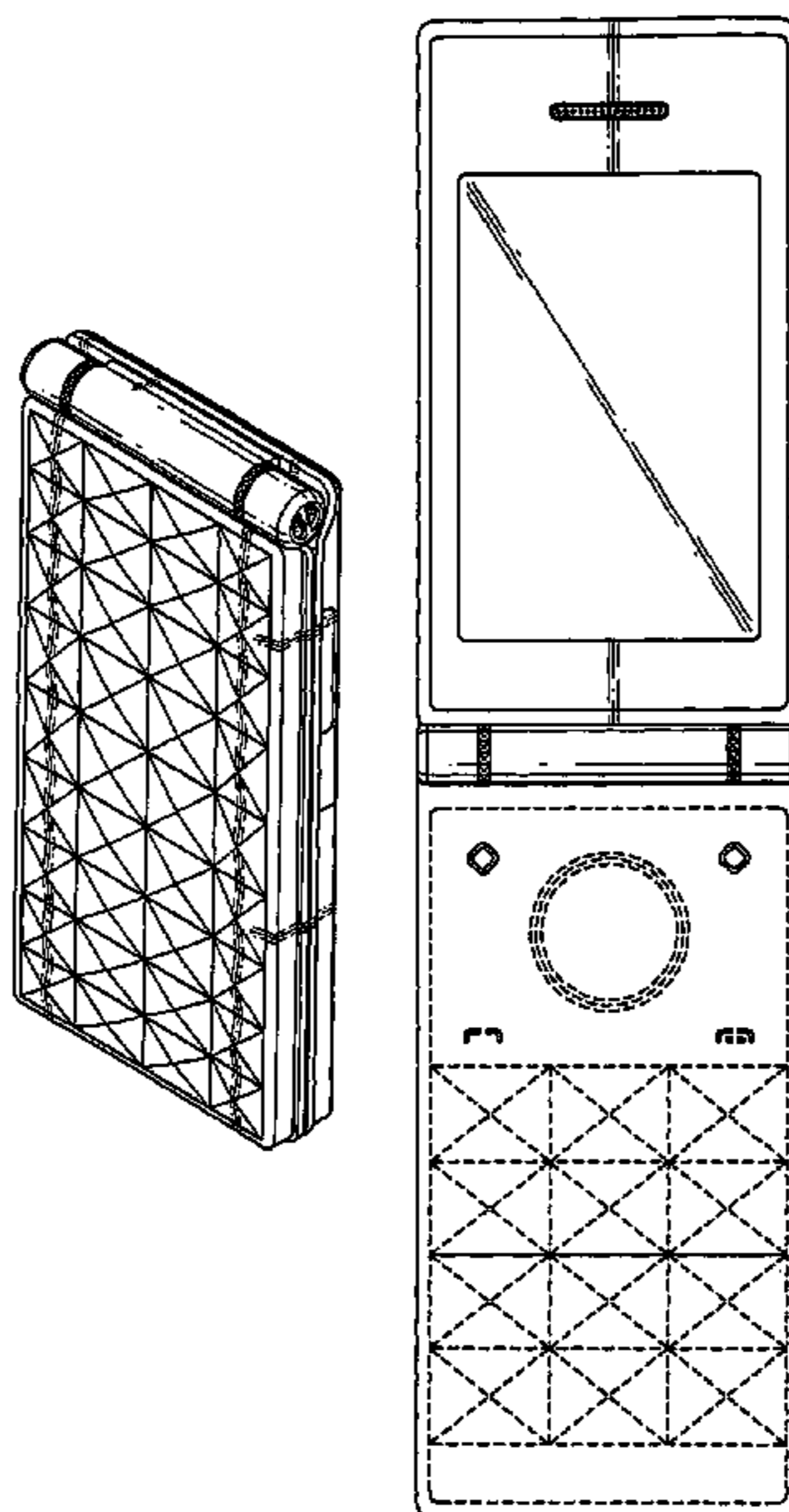

U.S. PATENT DOCUMENTS

D602,894 S * 10/2009 Lepoultier et al. ... D14/138 AB
D612,827 S * 3/2010 Song et al. D14/138 AB
D613,718 S * 4/2010 Lee et al. D14/138 AB
D614,600 S * 4/2010 Lee D14/138 AB
D615,057 S * 5/2010 Kim et al. D14/138 AB
D615,940 S * 5/2010 Kim et al. D14/138 AA
2010/0137040 A1* 6/2010 Kaito 455/575.3

OTHER PUBLICATIONS

Samsung S5150 Diva folder telephone, announced Dec. 2009, [online], [site visited Jun. 18, 2010]. Available from Internet, <URL: <http://www.gsmarena.com>>.*

Nokia 7070 Prism telephone, announced Apr. 2008, [online], [site visited Jun. 18, 2010]. Available from Internet, <URL: <http://www.gsmarena.com>>.*

Sony Ericsson Z555 telephone, announced Jan. 2008, [online], [site visited Jun. 18, 2010]. Available from Internet, <URL: <http://www.gsmarena.com>>.*

BenQ A520 telephone, announced 1st quarter 2005, [online], [site visited Jun. 18, 2010]. Available from Internet, <URL: <http://www.gsmarena.com>>.*

Philips X606 telephone, announced Apr. 2010, [online], [site visited Jun. 18, 2010]. Available from Internet, <URL: <http://www.gsmarena.com>>.*

Toshiba TS10 telephone, announced 3rd quarter 2005, [online], [site visited Jun. 18, 2010]. Available from Internet, <URL: <http://www.gsmarena.com>>.*

* cited by examiner

FIG. 1

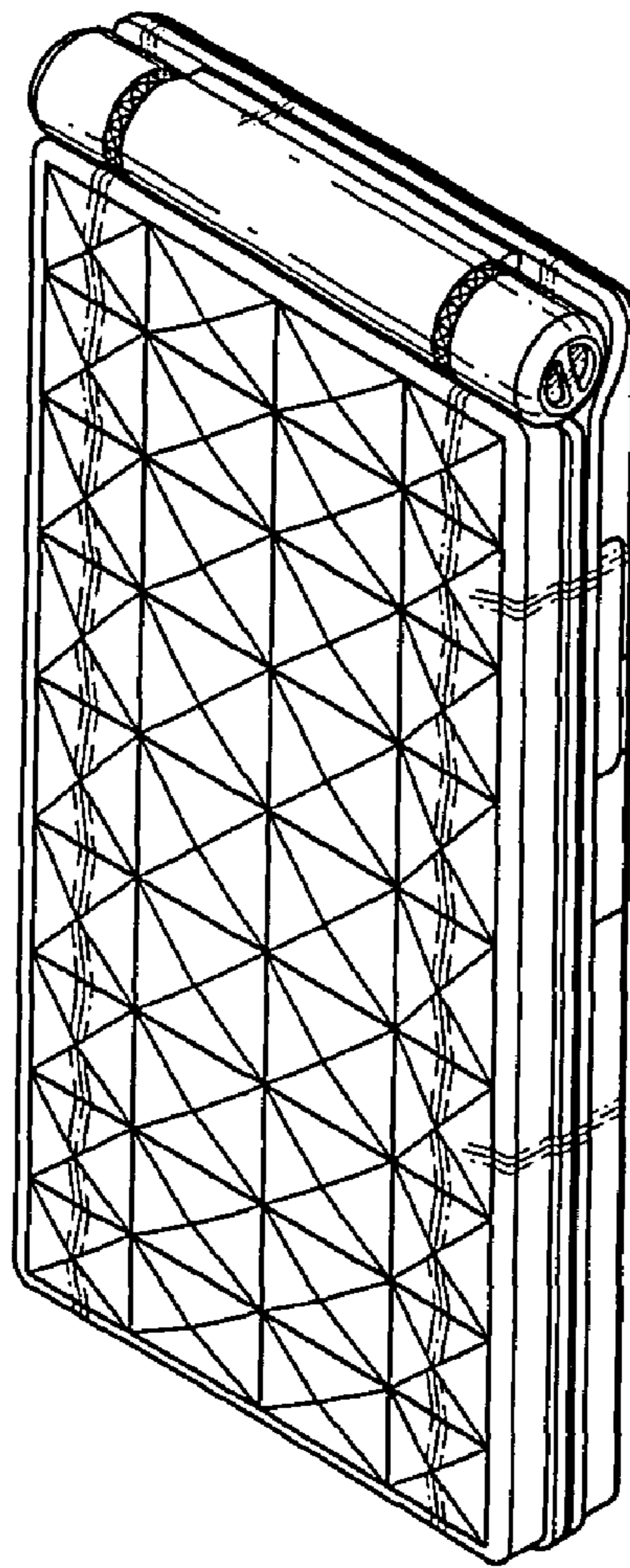

FIG. 2

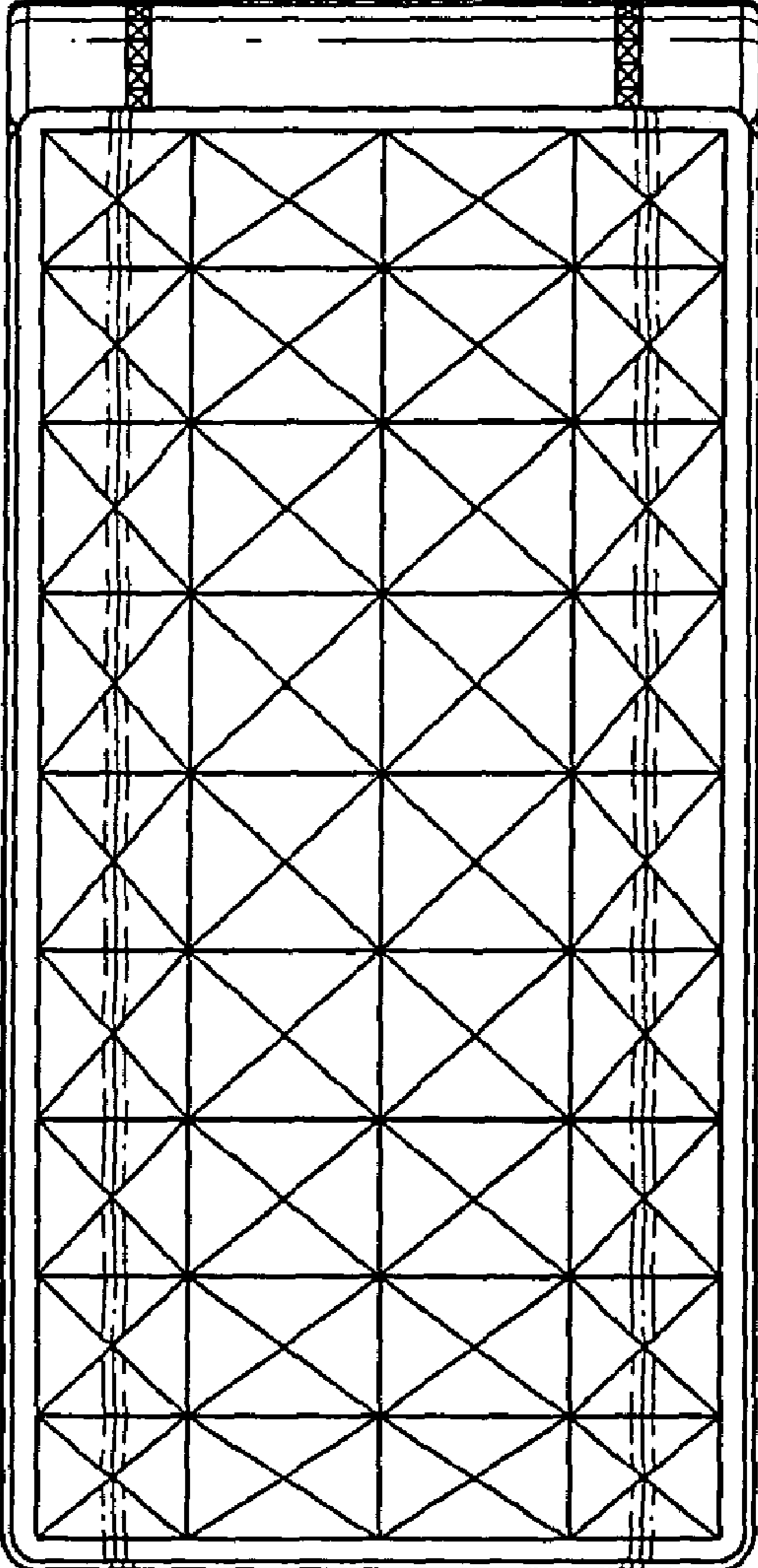

FIG. 3

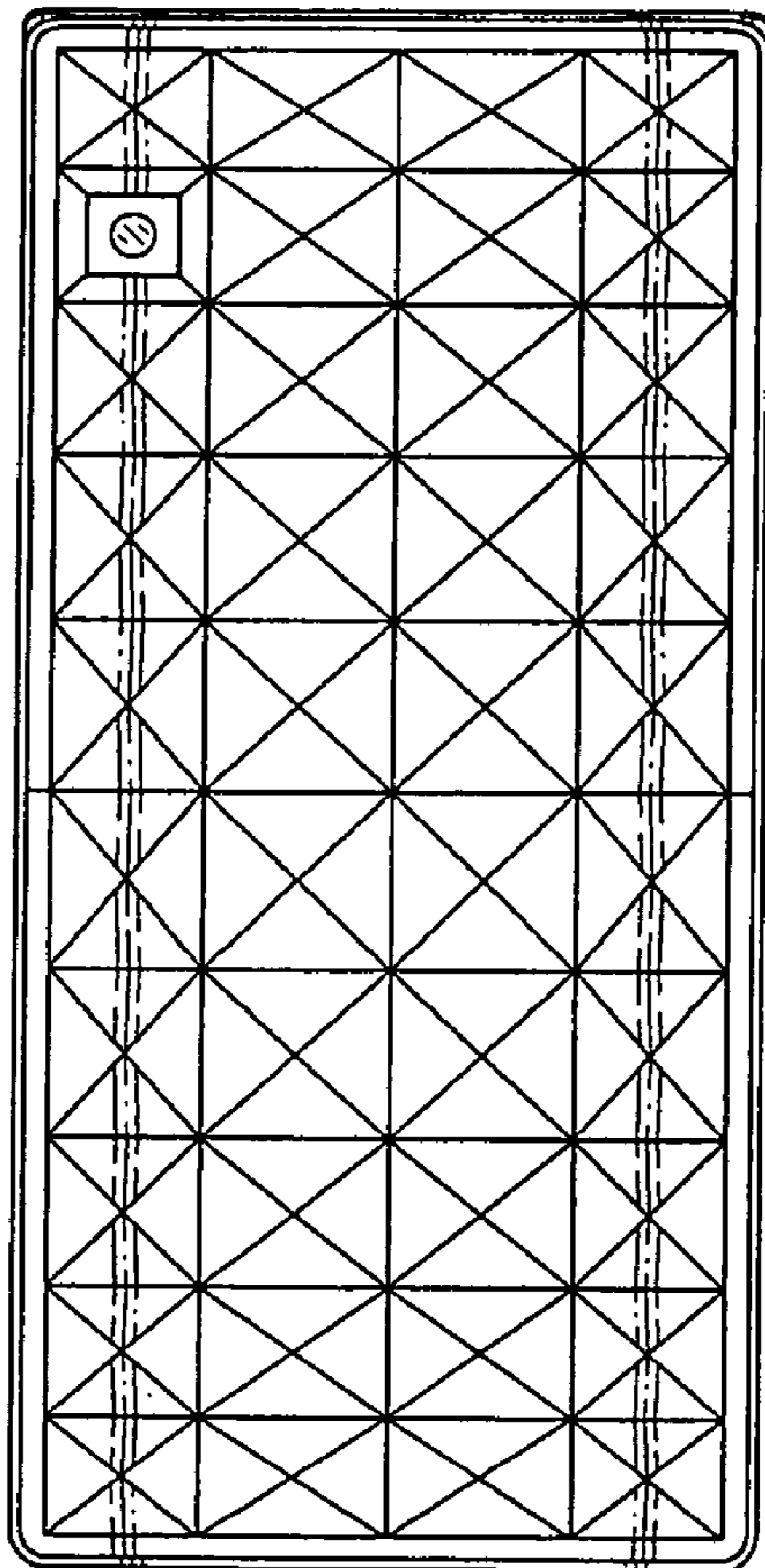

FIG. 4

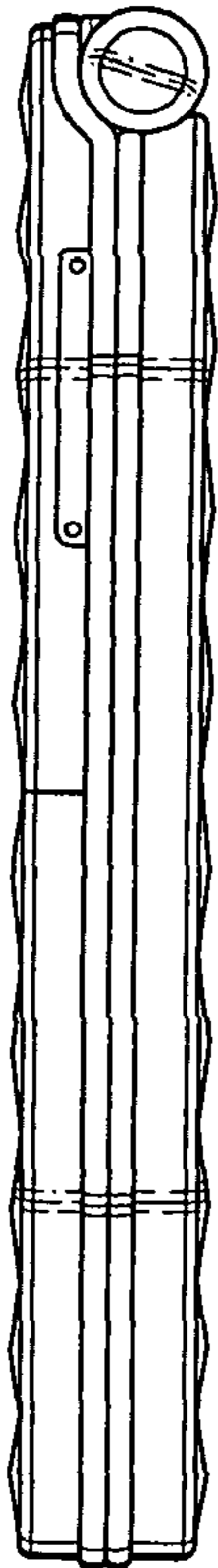

FIG. 5



FIG. 6

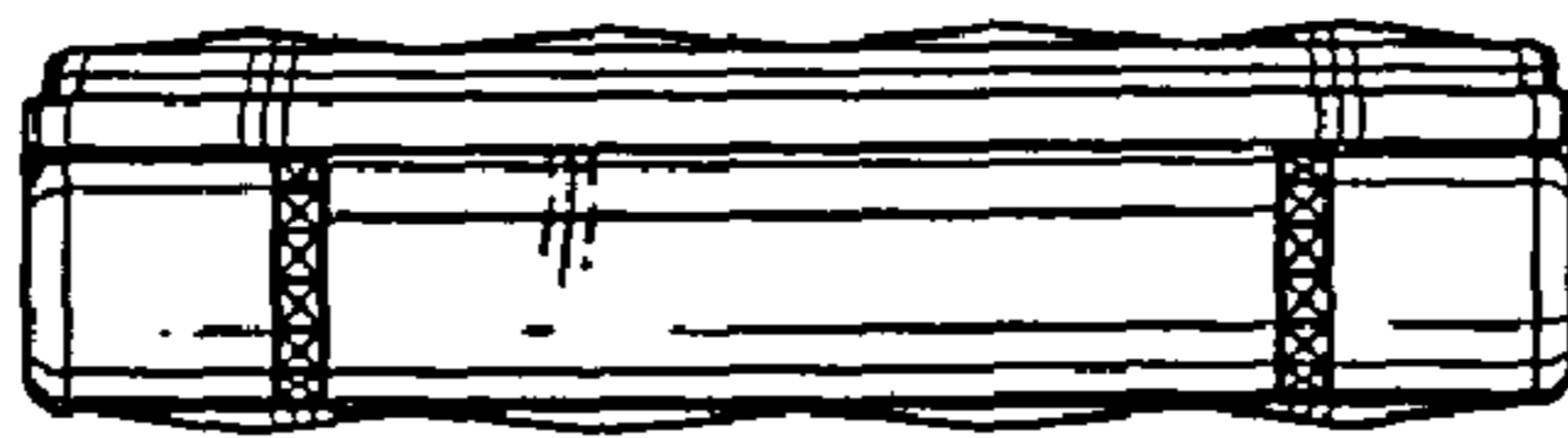

FIG. 7

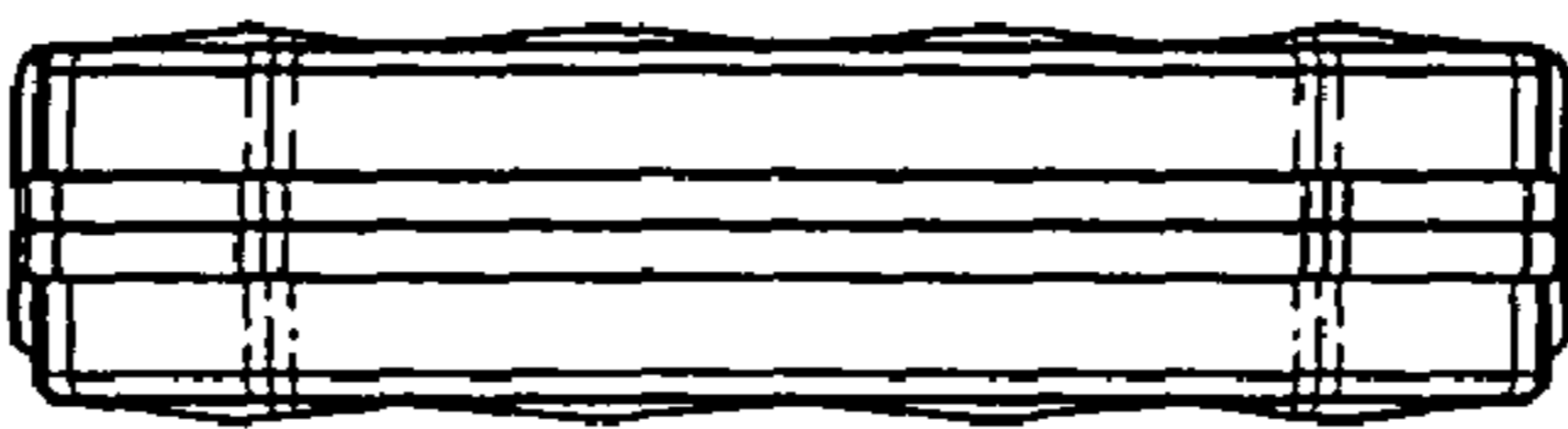

FIG. 8

