



US00D626521S

(12) **United States Design Patent**  
**Chen et al.**

(10) **Patent No.:** **US D626,521 S**  
(45) **Date of Patent:** **\*\* Nov. 2, 2010**

(54) **HEAT-DISSIPATING DEVICE FOR MEMORY**

(75) Inventors: **Wei-Hau Chen**, Taishan Shiang (TW);  
**Cheng-Hsien Kuo**, Taishan Shiang  
(TW); **Shih-Her Chen**, Taishan Shiang  
(TW)

(73) Assignee: **CompTake Technology Inc.**, Taipei  
County (TW)

(\*\*) Term: **14 Years**

(21) Appl. No.: **29/358,136**

(22) Filed: **Mar. 23, 2010**

(51) **LOC (9) Cl.** ..... **13-03**

(52) **U.S. Cl.** ..... **D13/179**

(58) **Field of Classification Search** ..... D13/179;  
165/80.2, 80.3, 104.33, 151, 122, 185; 361/704,  
361/709

See application file for complete search history.

(56) **References Cited**

**U.S. PATENT DOCUMENTS**

6,297,966	B1 *	10/2001	Lee et al.	361/799
6,672,379	B1 *	1/2004	Wang et al.	165/185
6,765,799	B1 *	7/2004	Huang	361/709
D496,006	S *	9/2004	Tsai et al.	D13/179
6,842,342	B1 *	1/2005	Lin	361/710
6,880,621	B2 *	4/2005	Wang	165/80.3
D531,965	S *	11/2006	Stathakis	D13/179
7,190,595	B2 *	3/2007	Chang	361/816
7,457,122	B2 *	11/2008	Lai et al.	361/704
D610,557	S *	2/2010	Chen et al.	D13/179
7,721,790	B2 *	5/2010	Sung	165/80.3
7,733,653	B1 *	6/2010	Hornig	361/704
2003/0026076	A1 *	2/2003	Wei	361/704

2007/0084584	A1 *	4/2007	Hashimoto	165/80.3
2007/0235162	A1 *	10/2007	Lin	165/80.3
2008/0011453	A1 *	1/2008	Liang	165/80.3
2008/0179043	A1 *	7/2008	Ho	165/78
2008/0264613	A1 *	10/2008	Chu	165/104.33
2009/0288803	A1 *	11/2009	Chen et al.	165/80.2
2009/0294099	A1 *	12/2009	Chen et al.	165/80.2
2010/0038054	A1 *	2/2010	Chen et al.	165/80.2
2010/0038055	A1 *	2/2010	Chen et al.	165/80.2

\* cited by examiner

*Primary Examiner*—Selina Sikder

(74) *Attorney, Agent, or Firm*—Muncy, Geissler, Olds & Lowe, PLLC

(57) **CLAIM**

The ornamental design for an heat-dissipating device for memory, as shown and described.

**DESCRIPTION**

FIG. 1 is a perspective view of an heat-dissipating device for memory showing my new design;

FIG. 2 is a front elevation view thereof;

FIG. 3 is a rear elevation view thereof;

FIG. 4 is a left side elevation view thereof;

FIG. 5 is a right side elevation view thereof;

FIG. 6 is a top plan view thereof;

FIG. 7 is a bottom plan view thereof;

FIG. 8 is an application diagram thereof; and,

FIG. 9 is an another application diagram thereof.

The broken line showing of the environment is for illustrative purposes only and forms no part of the claimed design.

**1 Claim, 7 Drawing Sheets**

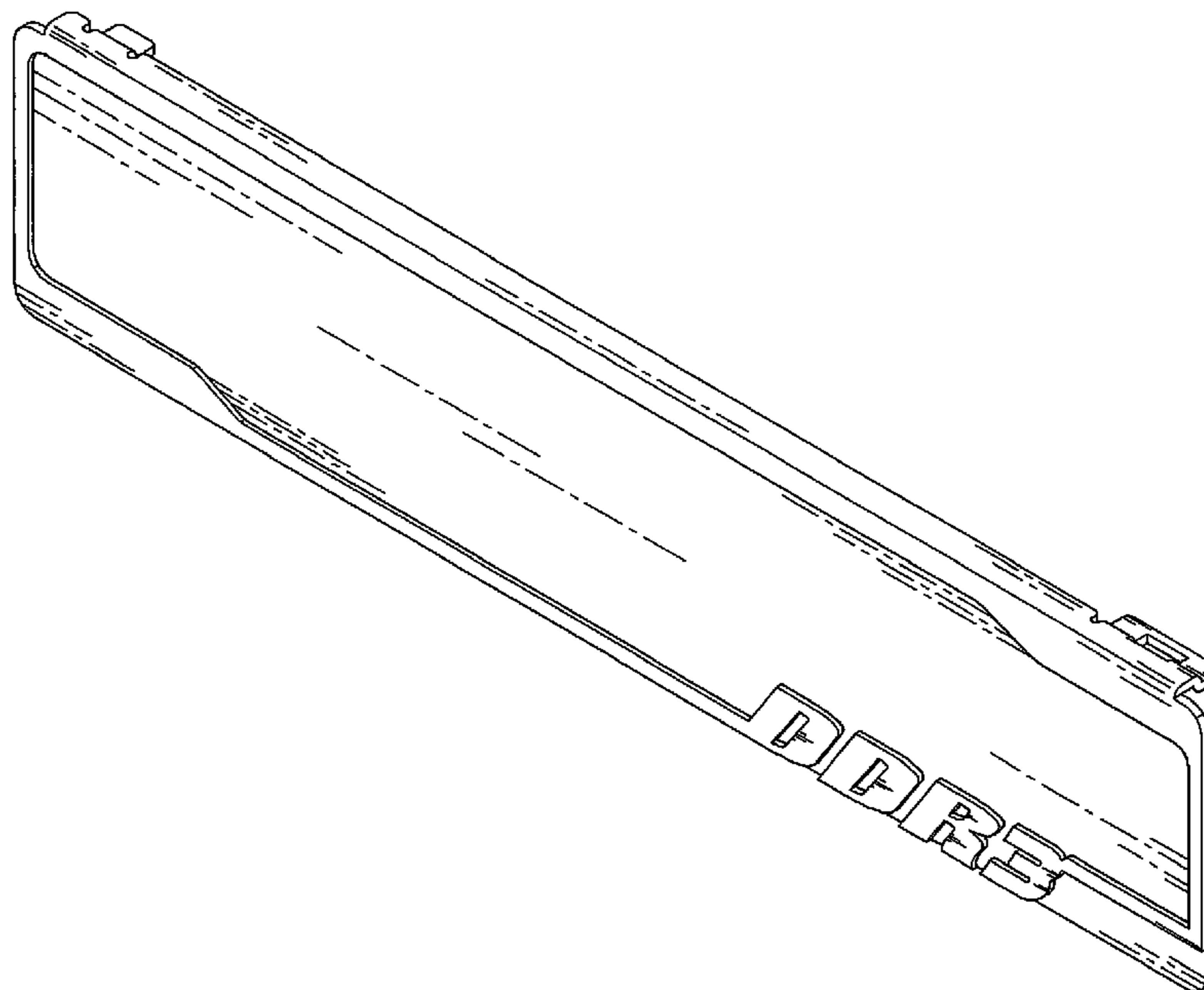

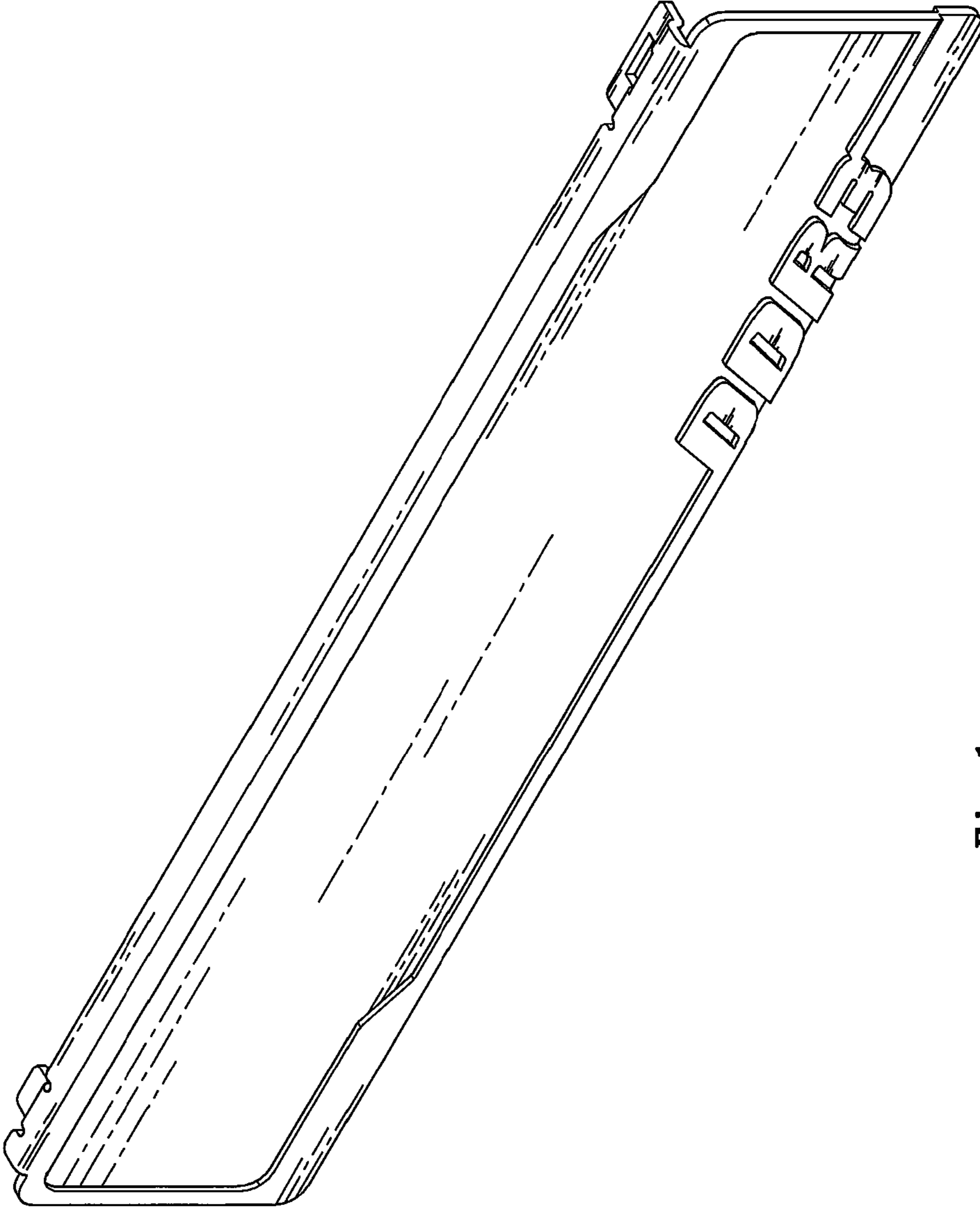

Fig. 1

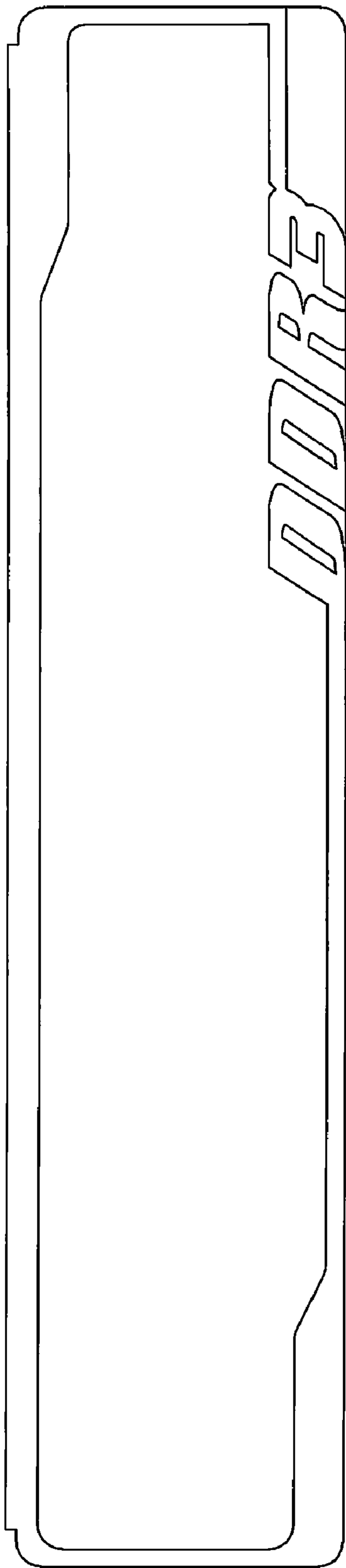

Fig. 2

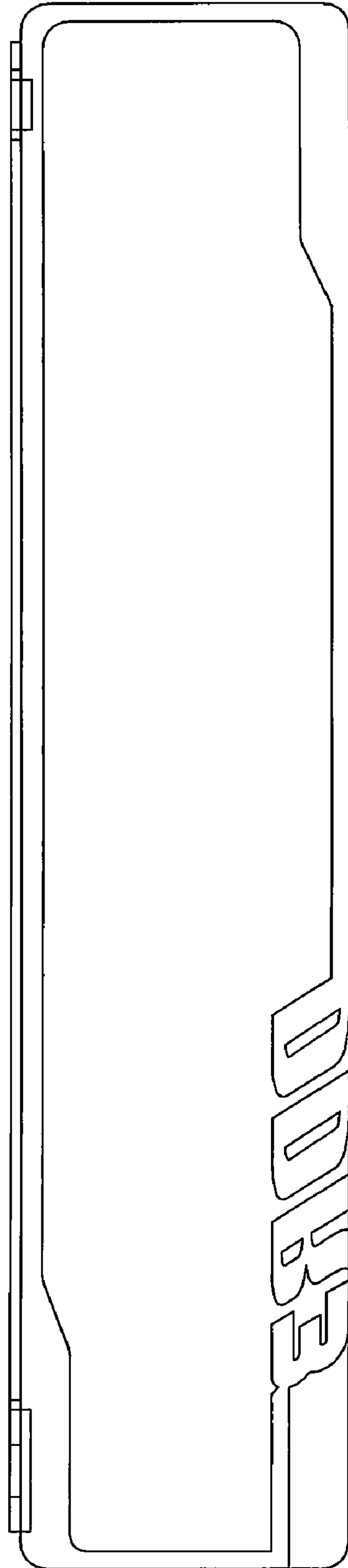

Fig. 3

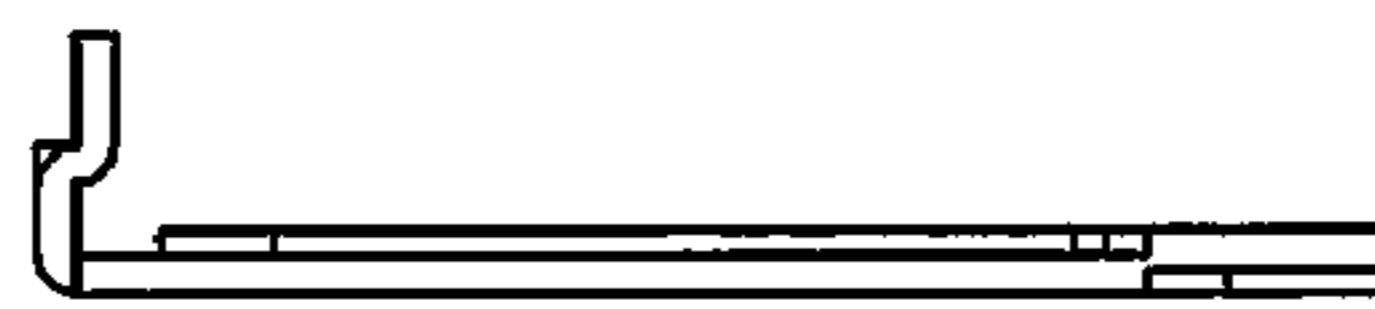

Fig. 5

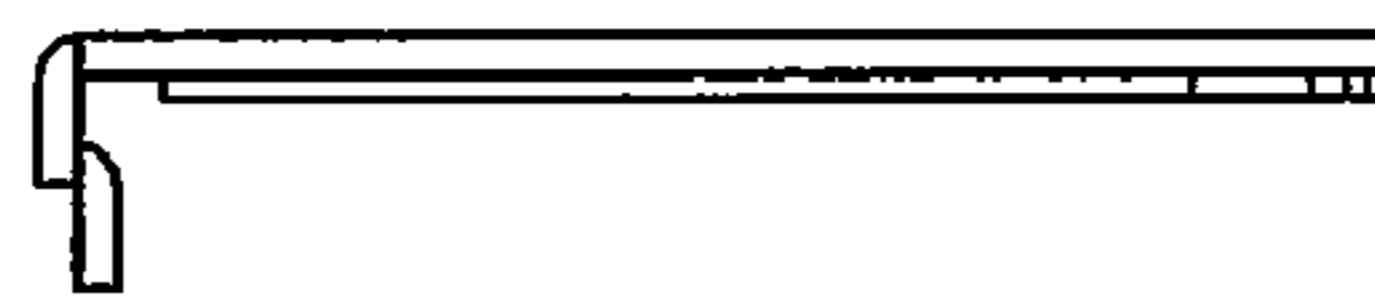

Fig. 4



Fig. 6

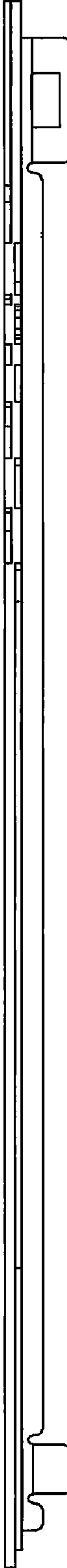

Fig. 7

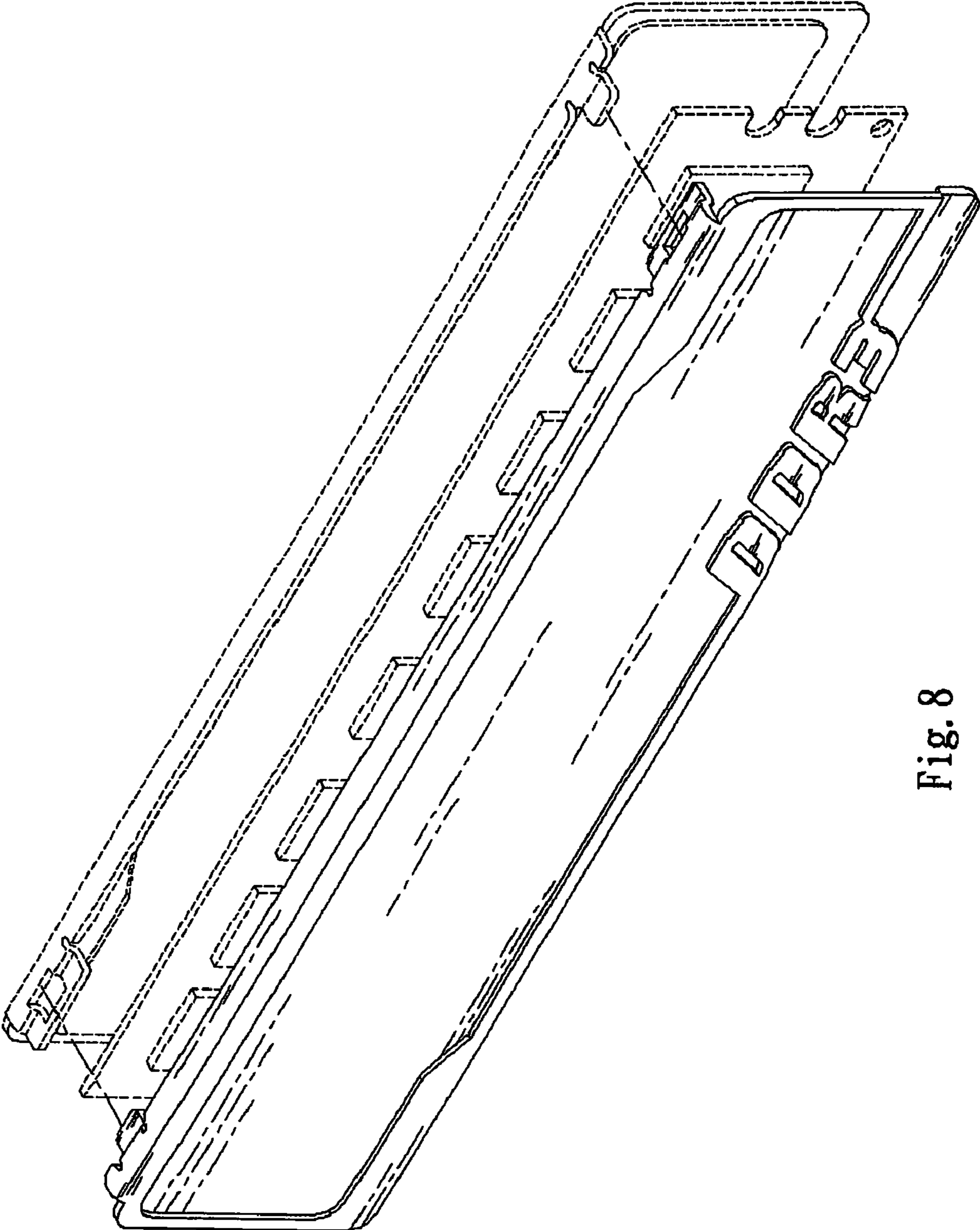

Fig. 8



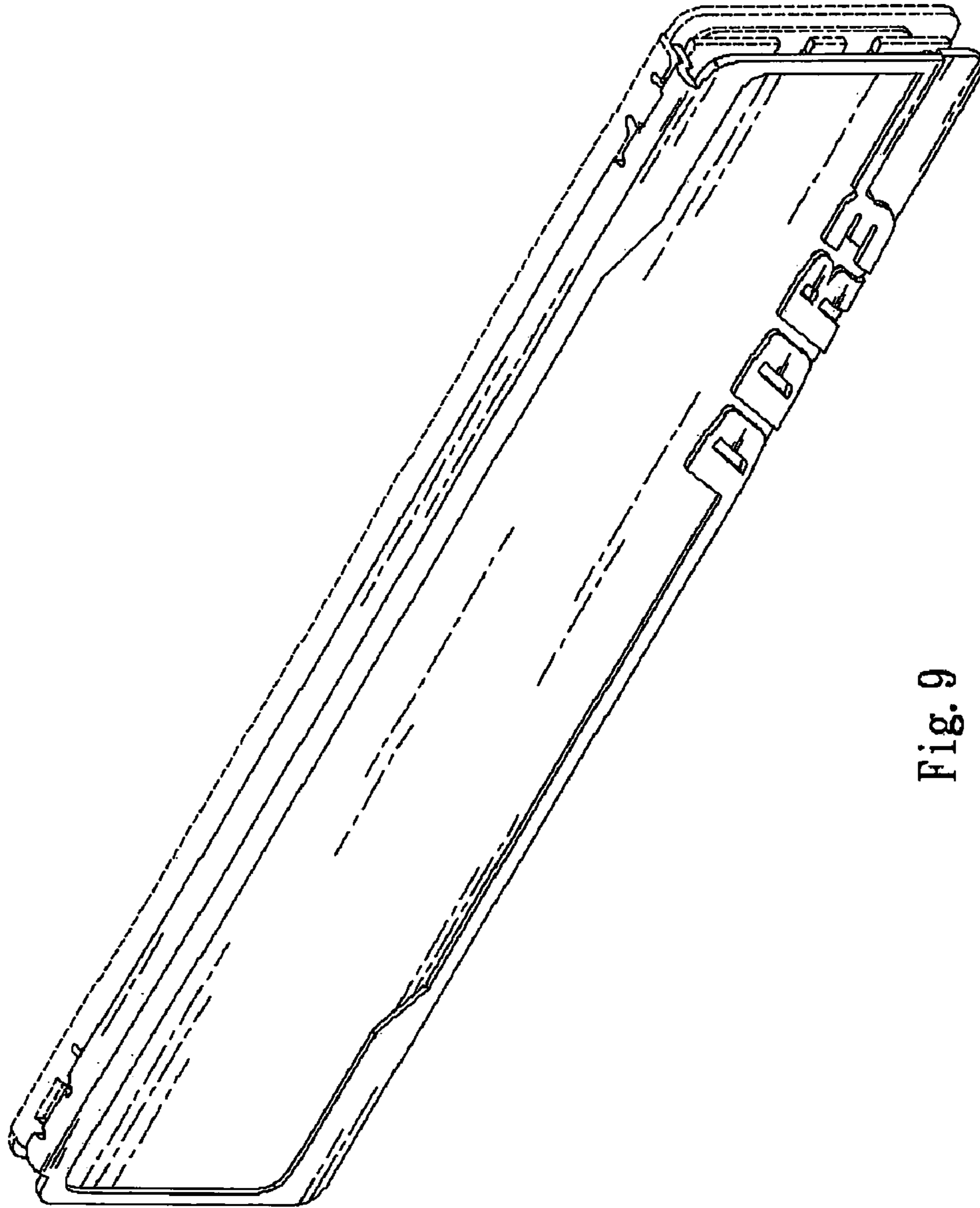

Fig. 9