



US00D626511S

(12) **United States Design Patent**
Nakajima et al.

(10) **Patent No.:** **US D626,511 S**

(45) **Date of Patent:** **** Nov. 2, 2010**

(54) **ELECTRICAL CONNECTOR**

(75) Inventors: **Takamitsu Nakajima**, Tokyo (JP);
Takeshi Shindo, Tokyo (JP); **Koji Hayashi**, Tokyo (JP)

(73) Assignee: **Japan Aviation Electronics Industry, Limited**, Tokyo (JP)

(**) Term: **14 Years**

(21) Appl. No.: **29/349,415**

(22) Filed: **Mar. 31, 2010**

(30) **Foreign Application Priority Data**

Feb. 3, 2010 (JP) 2010-002465

(51) **LOC (9) Cl.** **13-03**

(52) **U.S. Cl.** **D13/147**

(58) **Field of Classification Search** D13/133,
D13/147, 154, 184; 439/260, 329, 395, 422,
439/492-499

See application file for complete search history.

(56) **References Cited**

U.S. PATENT DOCUMENTS

D497,594 S *	10/2004	Hisamatsu et al.	D13/147
D606,495 S *	12/2009	Hamauchi	D13/147
D607,410 S *	1/2010	Ikari	D13/147
D608,290 S *	1/2010	Ikari	D13/147
D609,648 S *	2/2010	Kai et al.	D13/147
D619,095 S *	7/2010	Yotsutani	D13/147

* cited by examiner

Primary Examiner—Daniel D Bui

(74) *Attorney, Agent, or Firm*—Collard & Roe, P.C.

(57) **CLAIM**

The ornamental design for an electrical connector, as shown and described.

DESCRIPTION

FIG. 1 is a front elevational view of an electrical connector showing our new design;

FIG. 2 is a rear elevational view thereof;

FIG. 3 is a left side elevational view thereof;

FIG. 4 is a right side elevational view thereof;

FIG. 5 is a top plan view thereof;

FIG. 6 is a bottom plan view thereof;

FIG. 7 is a cross-sectional view showing the electrical connector of FIG. 1, taken along lines VII—VII;

FIG. 8 a front, top and right side perspective view thereof;

FIG. 9 is a rear, right and bottom side perspective view thereof;

FIG. 10 is an enlarged view showing the electrical connector of FIG. 4; and,

FIG. 11 is an enlarged view showing the electrical connector of FIG. 7.

1 Claim, 11 Drawing Sheets

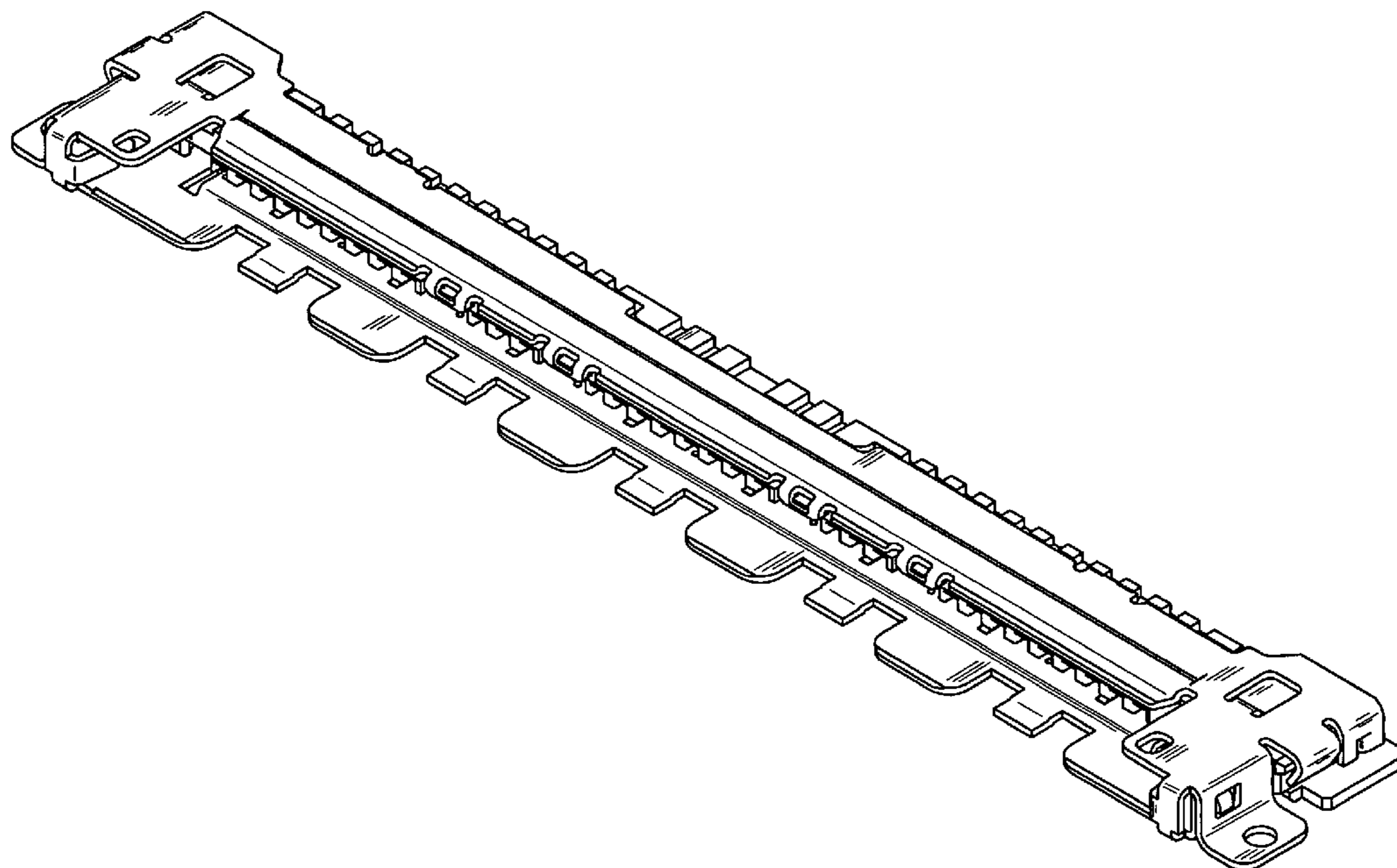

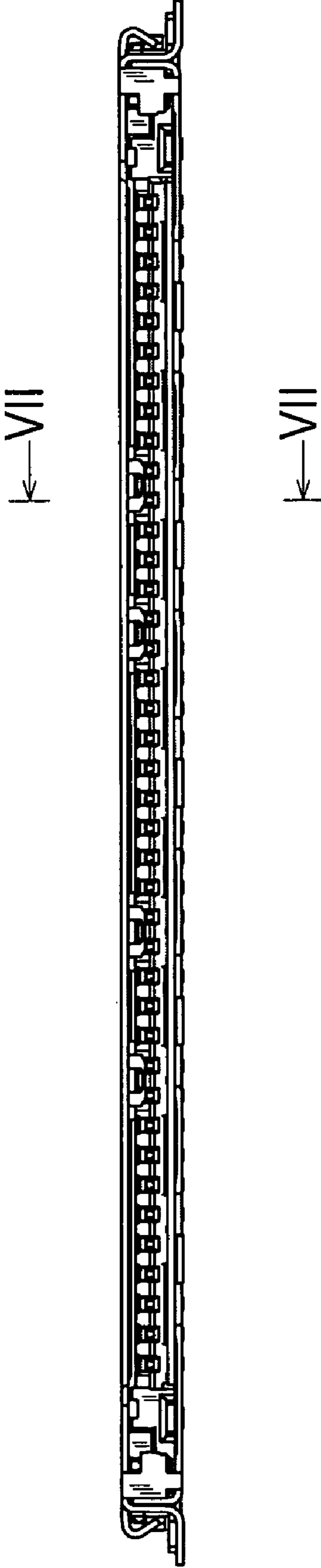

FIG. 1



FIG. 2



FIG. 3

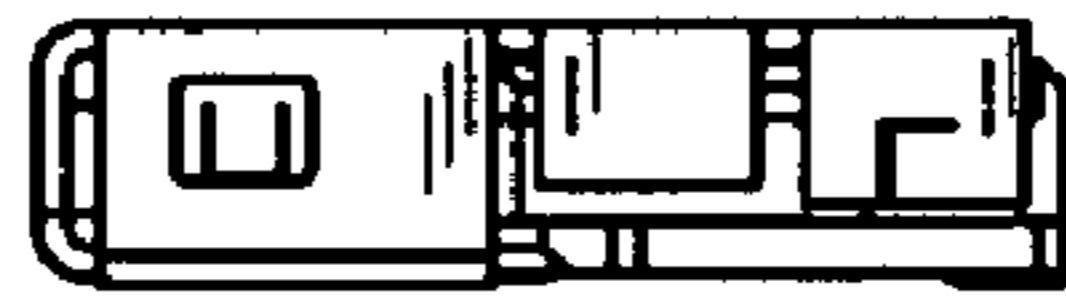

FIG. 4

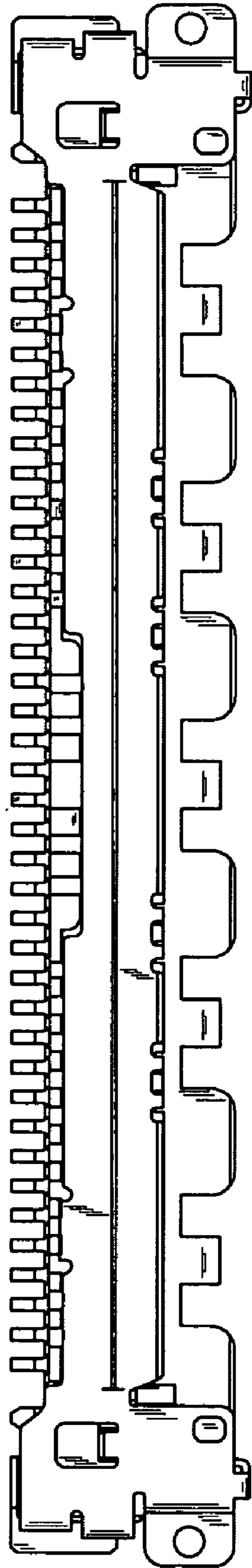

FIG. 5

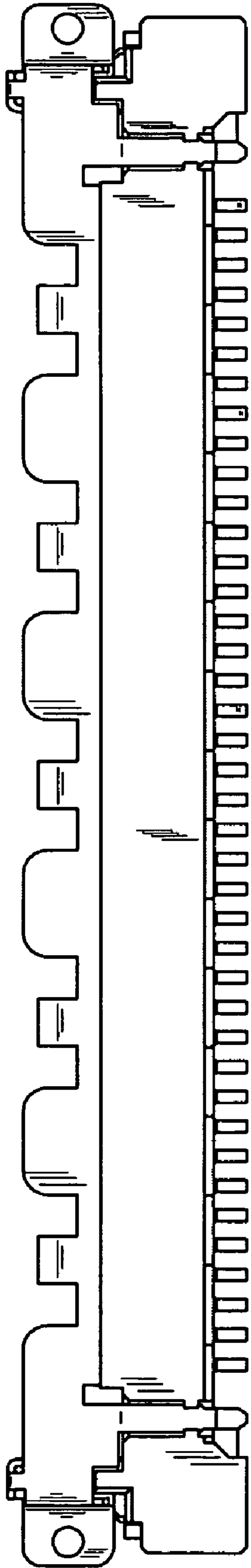

FIG. 6

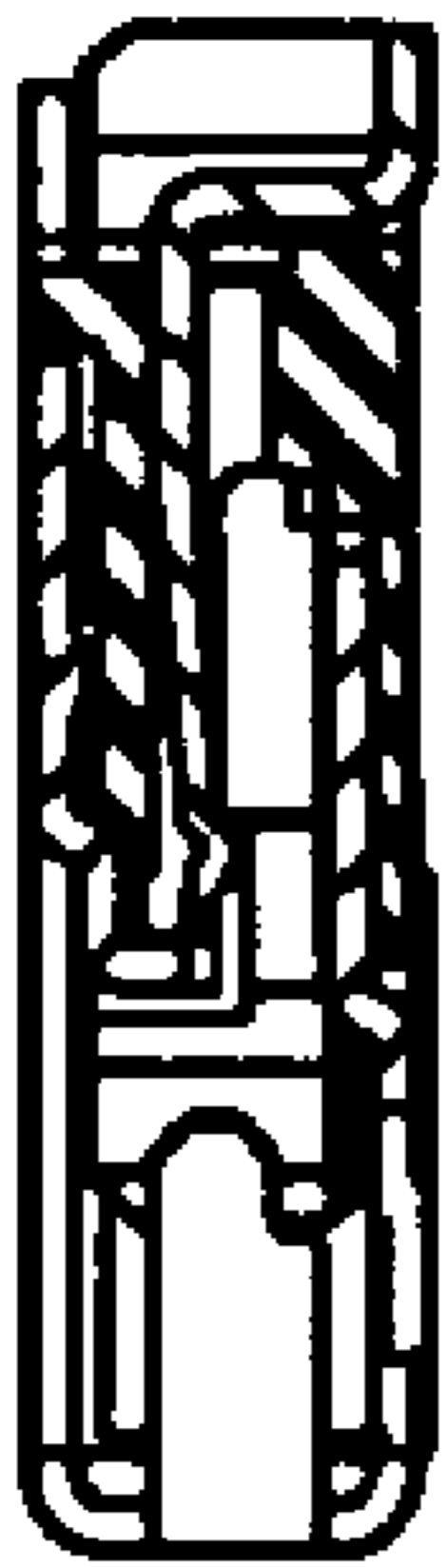

FIG. 7

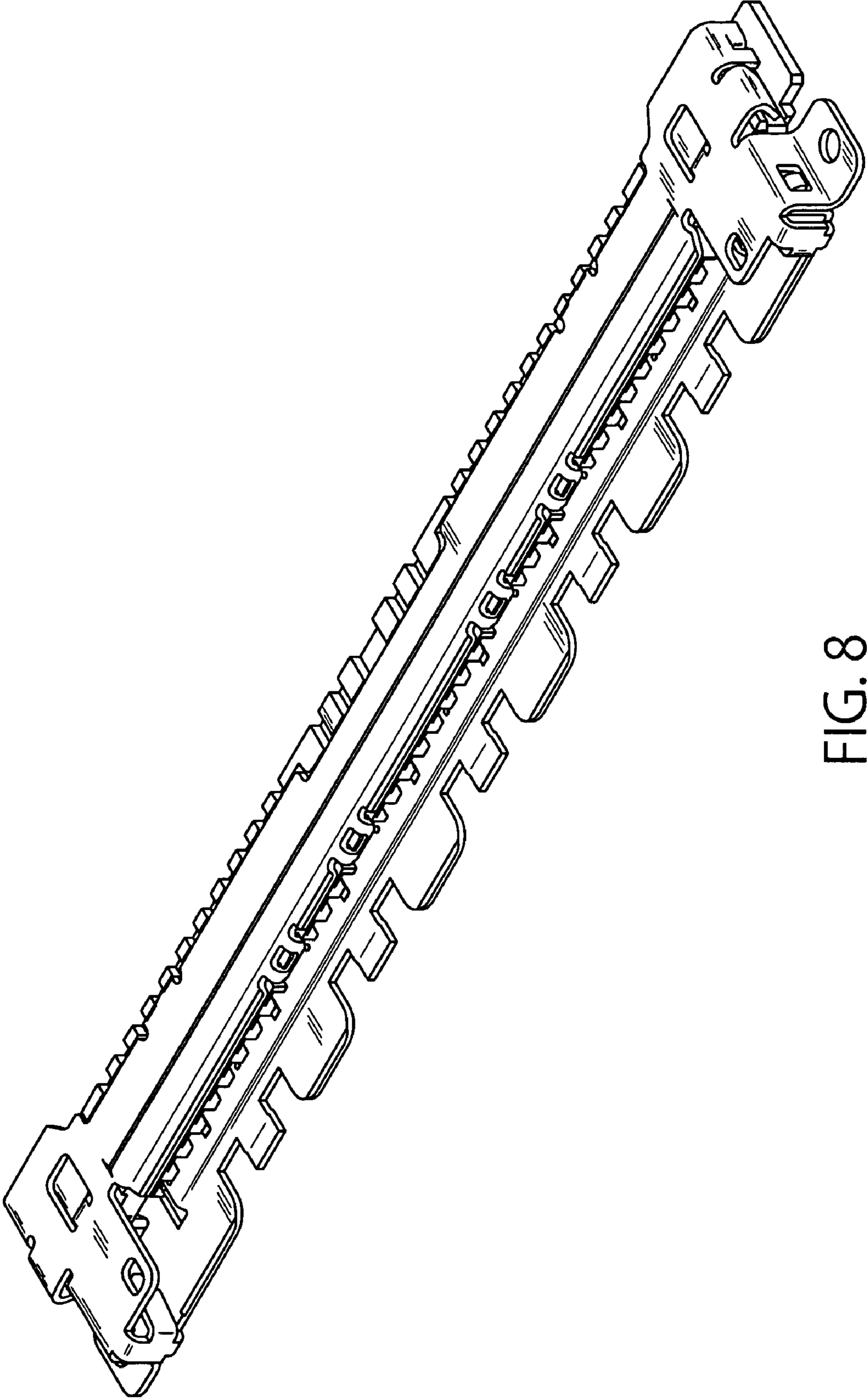

FIG. 8

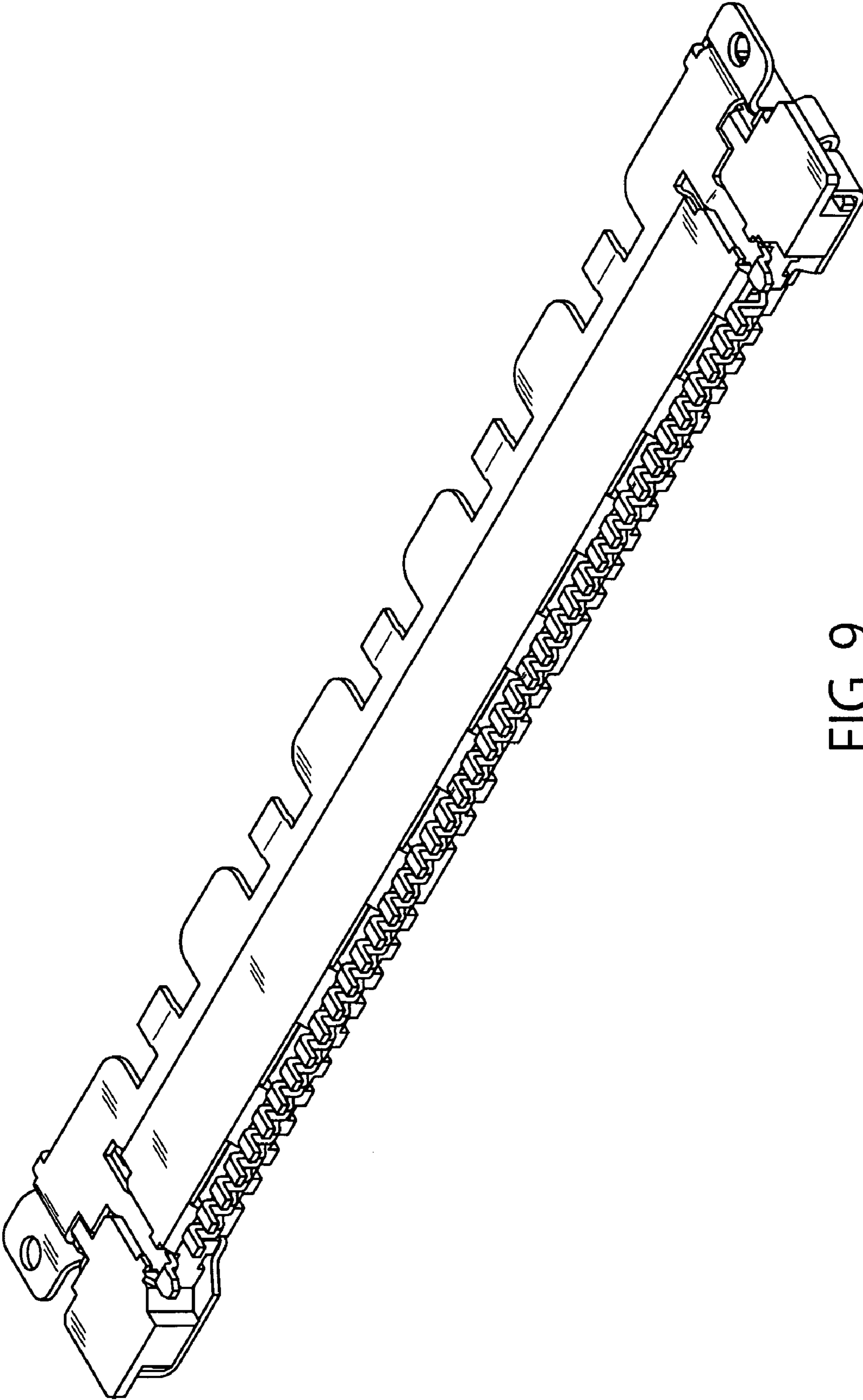

FIG. 9

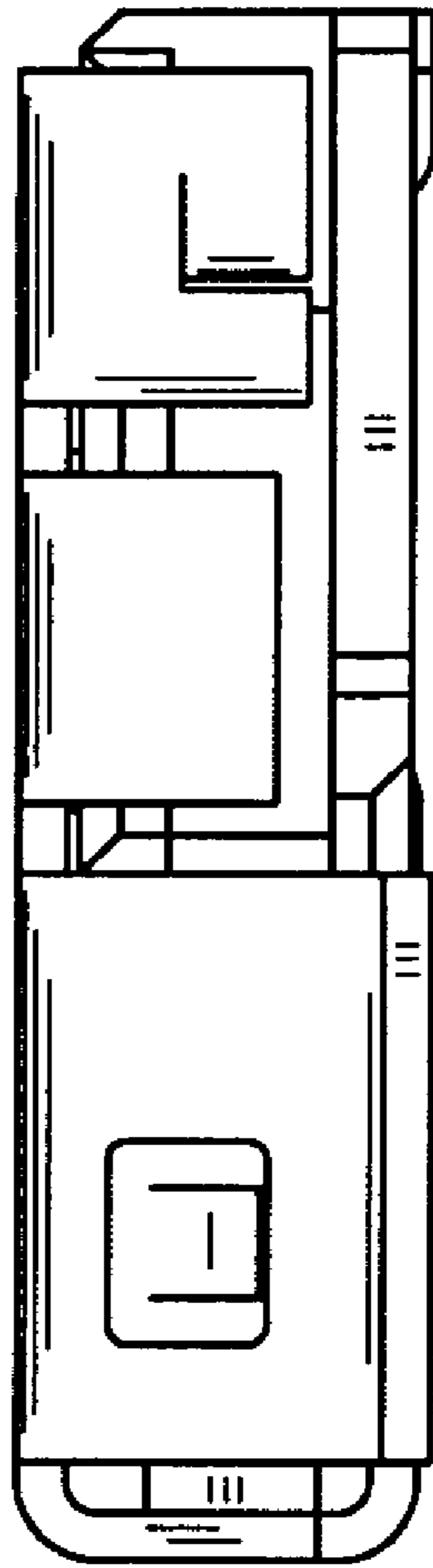

FIG. 10

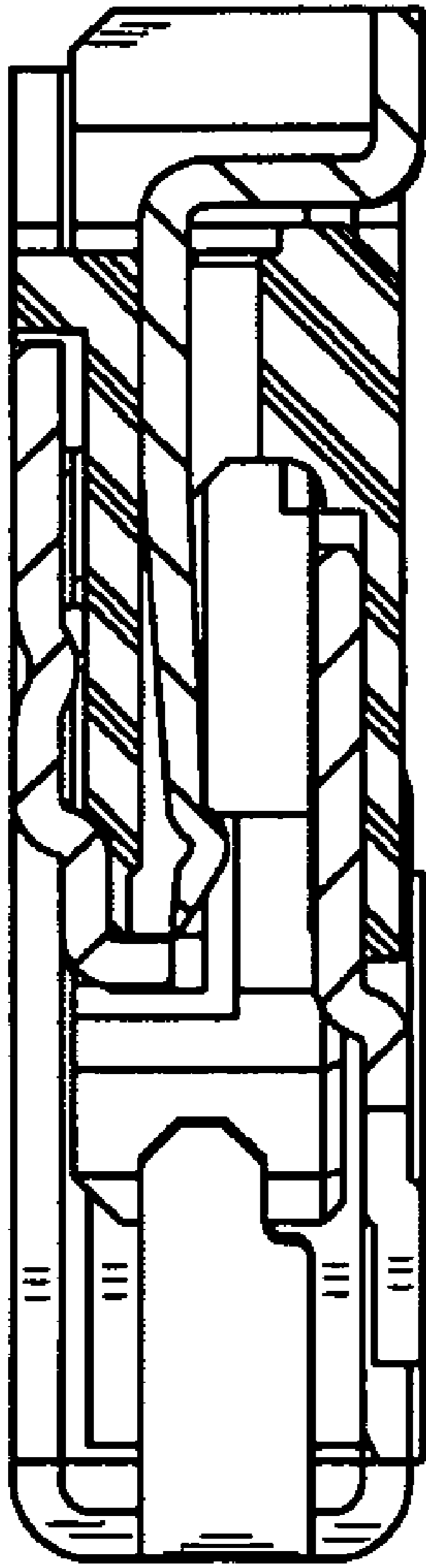

FIG. 11