



US00D626421S

(12) **United States Design Patent**
Szymula

(10) **Patent No.:** **US D626,421 S**

(45) **Date of Patent:** **** Nov. 2, 2010**

(54) **PERFUME BOTTLE**

(75) Inventor: **Mariusz Szymula**, Grudziadz (PL)

(73) Assignee: **La Rive S.A.**, Grudziadz (PL)

(**) Term: **14 Years**

(21) Appl. No.: **29/335,906**

(22) Filed: **Apr. 24, 2009**

(30) **Foreign Application Priority Data**

Mar. 24, 2009 (EP) 001111033

(51) **LOC (9) Cl.** **09-01**

(52) **U.S. Cl.** **D9/559**; D9/452; D9/561

(58) **Field of Classification Search** D9/434,
D9/435, 452, 516, 519, 520, 529, 545, 546,
D9/559, 561, 569, 570, 575, 682, 686, 687,
D9/688, 689, 690, 691; 215/381-385; 220/602,
220/660, 662, 665

See application file for complete search history.

(56) **References Cited**

U.S. PATENT DOCUMENTS

D31,706 S *	10/1899	Schies	D9/546
D37,580 S *	10/1905	Sommer	D9/545
D47,002 S *	2/1915	Lloyd	D9/545
D52,952 S *	2/1919	Green	D9/556
D61,506 S *	9/1922	Newell	D9/544
D62,996 S *	9/1923	Kropff	D9/544
D69,486 S *	2/1926	Braun	D9/545
D89,141 S *	1/1933	Wilson	D9/559
D98,601 S *	2/1936	Mann	D9/548
D106,226 S *	9/1937	Wildman	D9/546
D109,755 S *	5/1938	Kelly	D9/523
D111,954 S *	11/1938	Buckingham	D9/544
D115,068 S *	5/1939	Jensen	D9/561
D183,424 S *	8/1958	Goldberg	D9/452
D198,054 S *	4/1964	Loewry	D9/504
D306,400 S *	3/1990	Beier-Rosetti	D9/546
D314,332 S *	2/1991	Sgariboldi	D9/544
D324,496 S *	3/1992	Poandl	D9/559
D337,258 S *	7/1993	Mansau	D9/691

D355,602 S *	2/1995	Buettner et al.	D9/505
D357,633 S *	4/1995	Granai	D9/553
D365,991 S *	1/1996	Varlet	D9/544
D366,422 S *	1/1996	Gobe	D9/544
D401,155 S *	11/1998	de Mourgues	D9/558
D431,779 S *	10/2000	Nosella	D9/520
D453,296 S *	2/2002	Granai	D9/519
D468,626 S *	1/2003	Jødal et al.	D9/693
D517,185 S *	3/2006	Chen	D23/366
D519,845 S *	5/2006	Ortiz	D9/651
D547,193 S *	7/2007	Blasko et al.	D9/529
D588,927 S *	3/2009	Antretter	D9/630
D596,950 S *	7/2009	Nevins et al.	D9/690
D605,948 S *	12/2009	Sposato	D9/546
D609,575 S *	2/2010	Sherwood	D9/545
D611,829 S *	3/2010	Van Der Straeten	D9/545

* cited by examiner

Primary Examiner—Stella M Reid

Assistant Examiner—Elizabeth J Oswecki

(74) *Attorney, Agent, or Firm*—Katten Muchin Rosenman LLP

(57) **CLAIM**

The ornamental design for a perfume bottle, as shown and described.

DESCRIPTION

FIG. 1 is a front perspective view of a perfume bottle showing my new design;

FIG. 2 is a front view thereof, the rear view being the same thereof;

FIG. 3 is a side view thereof, the other side view being the same thereof;

FIG. 4 is a right edge frontal view thereof, the rear view being the same thereof;

FIG. 5 is a left edge frontal view thereof, the rear view being the same thereof;

FIG. 6 is a top view thereof; and,

FIG. 7 is a bottom view thereof.

1 Claim, 6 Drawing Sheets

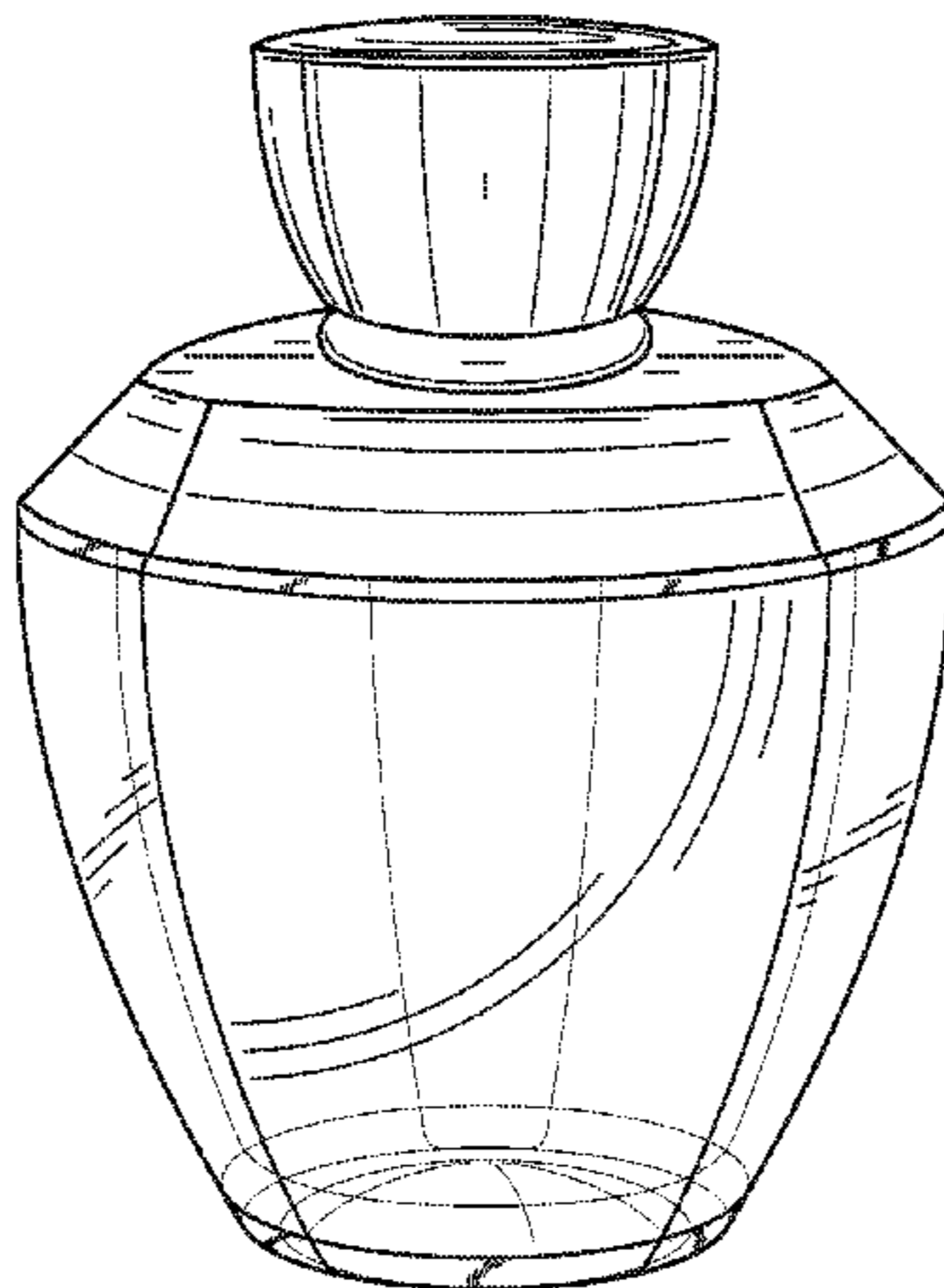

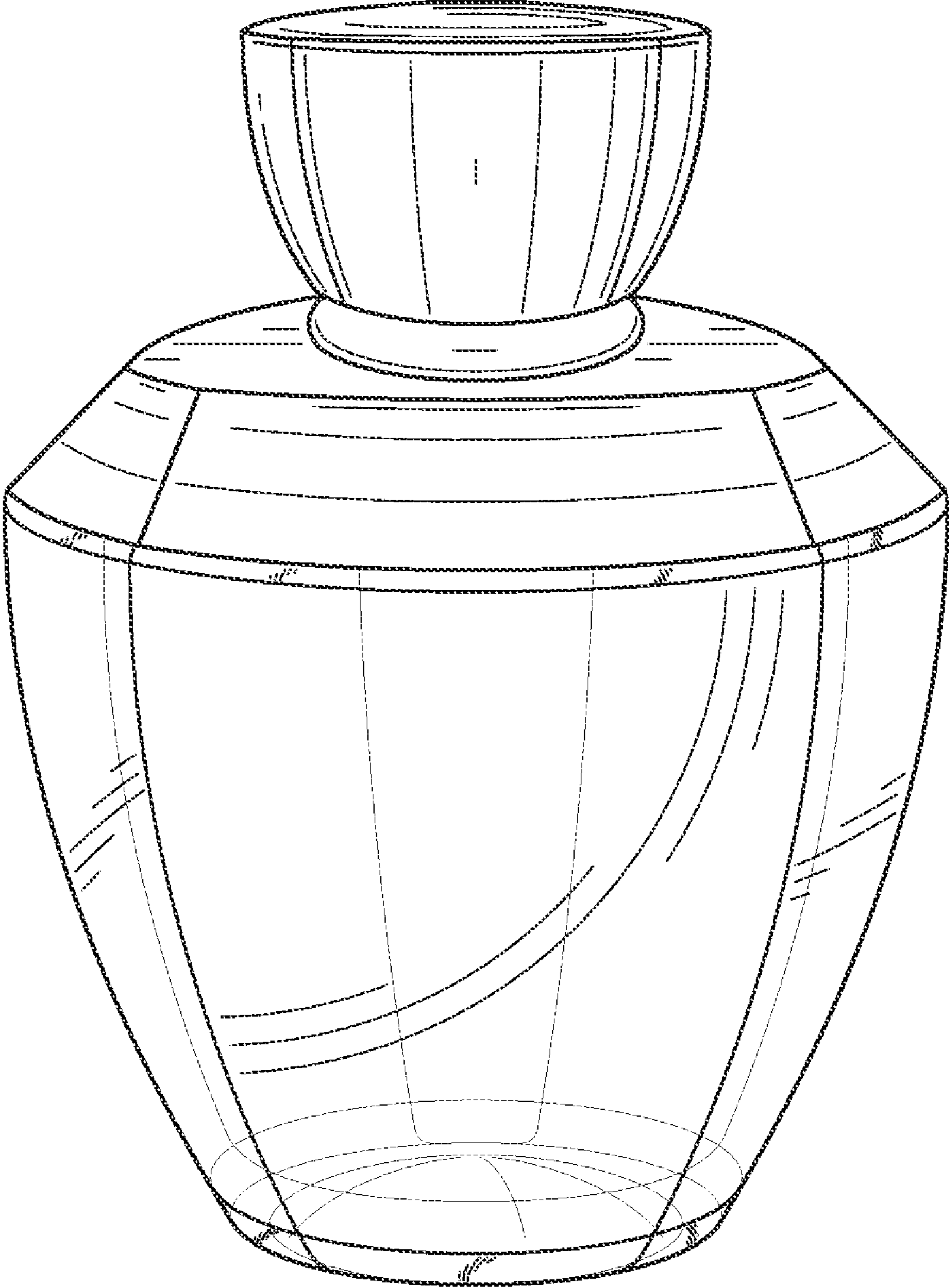

FIG. 1

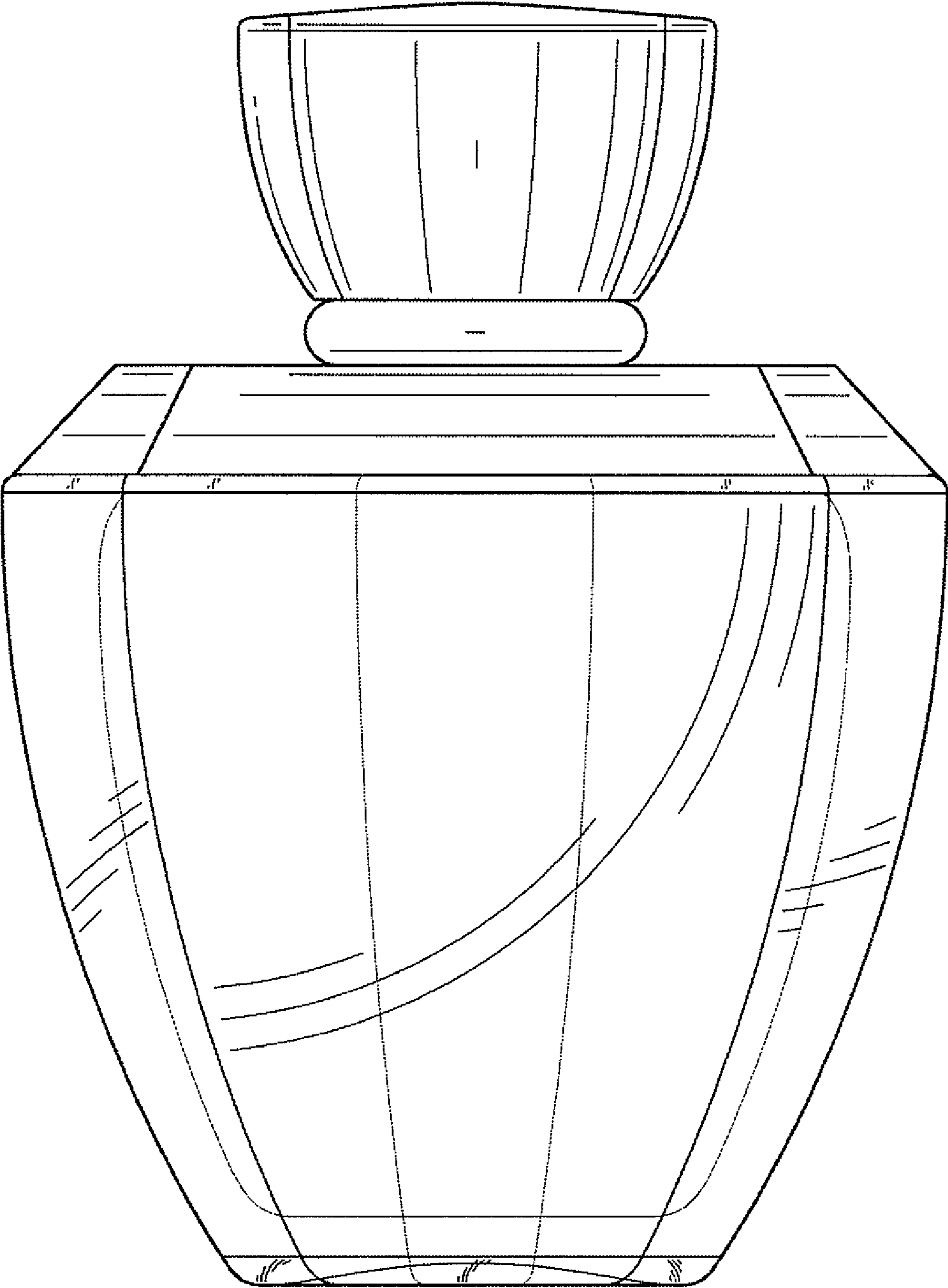

FIG. 2

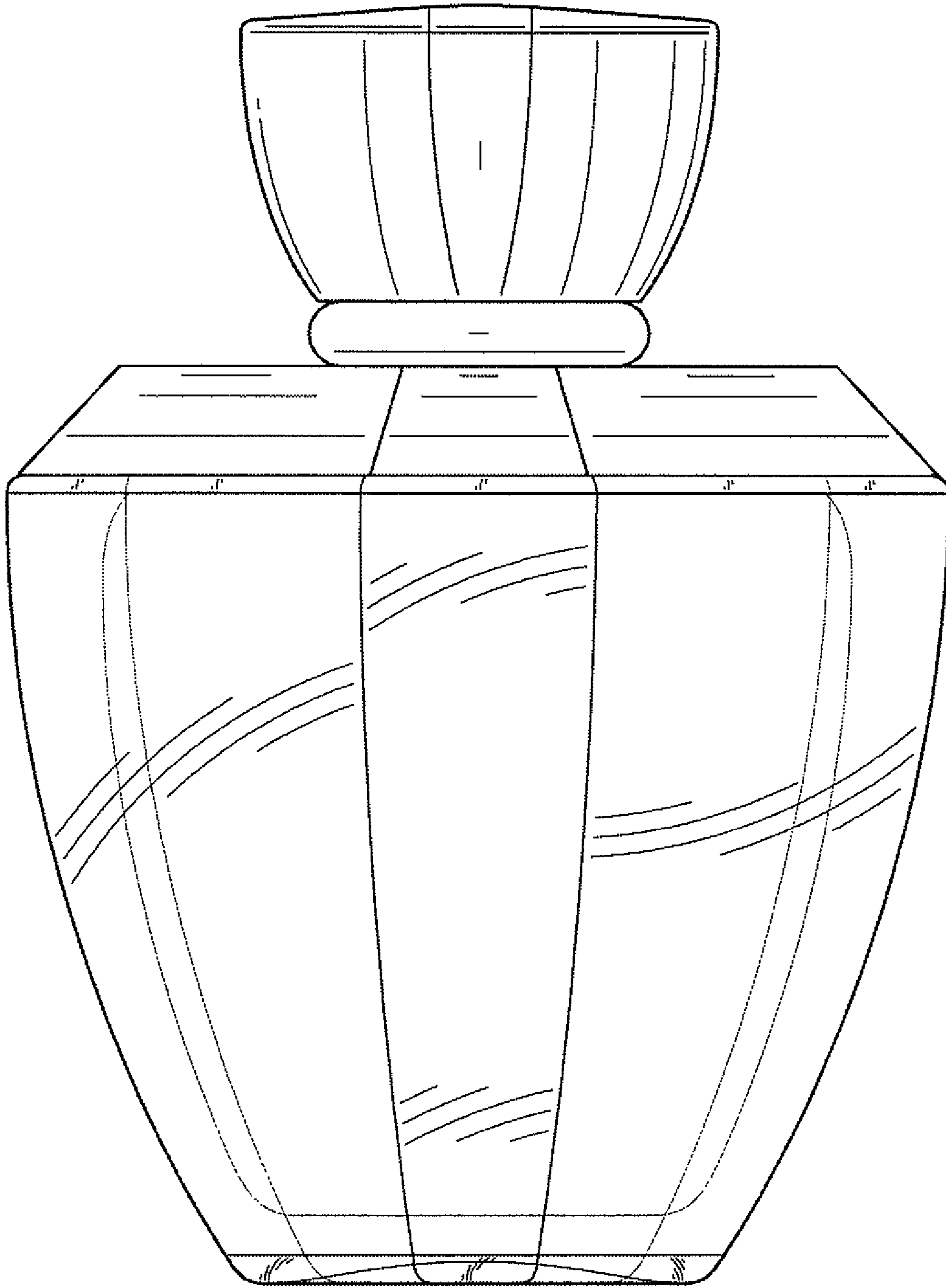

FIG. 3

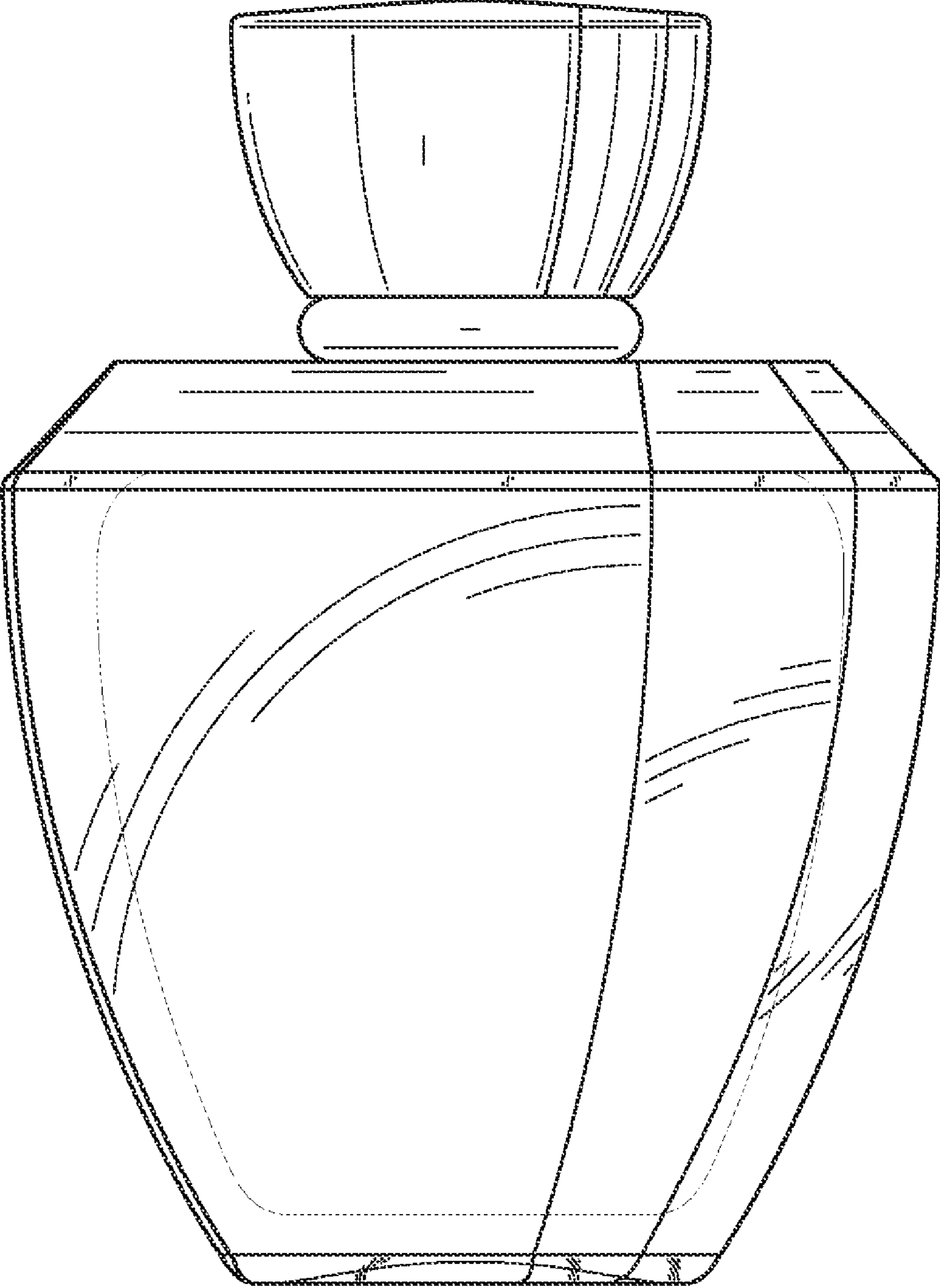

FIG. 4

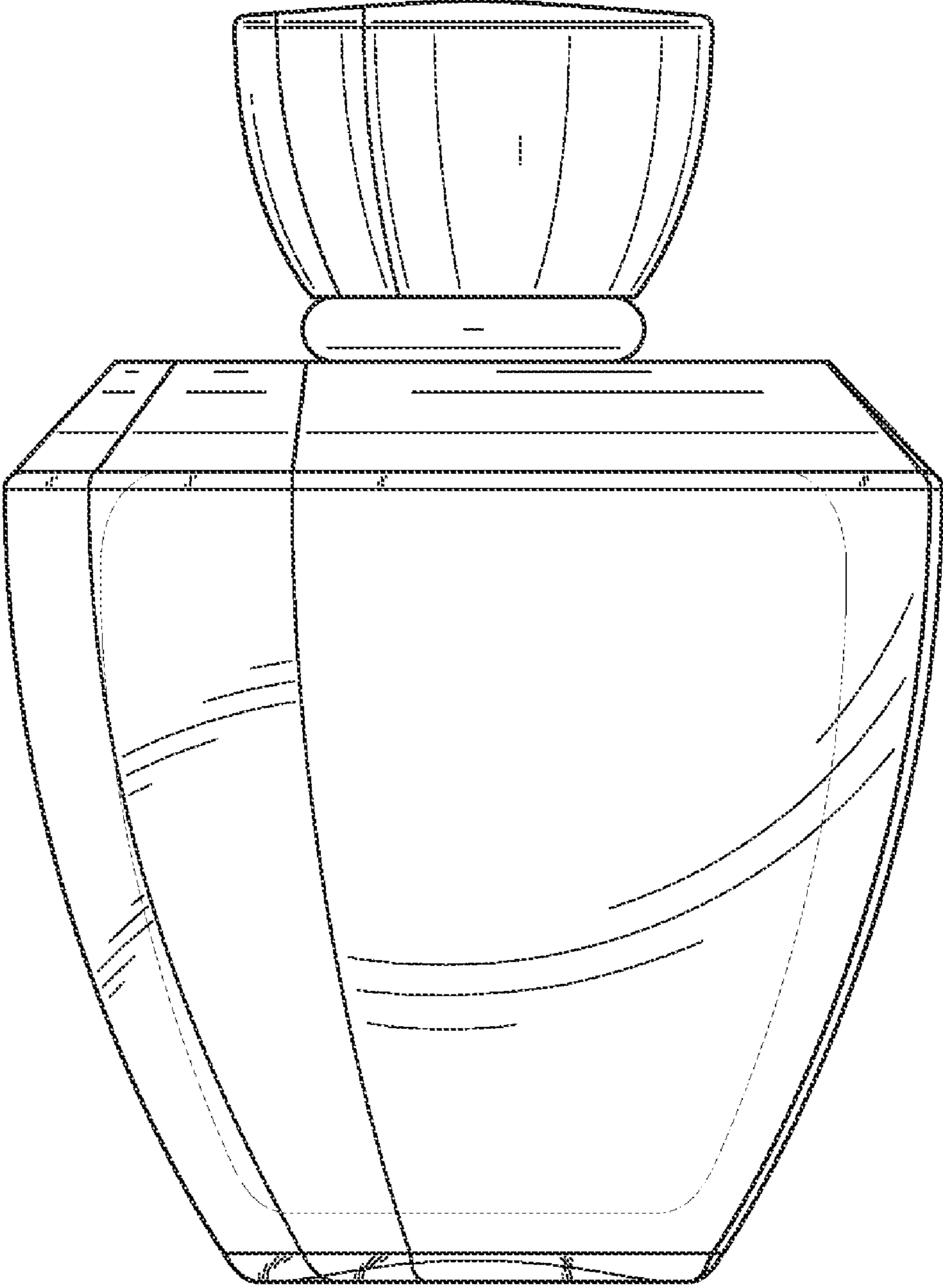

FIG. 5

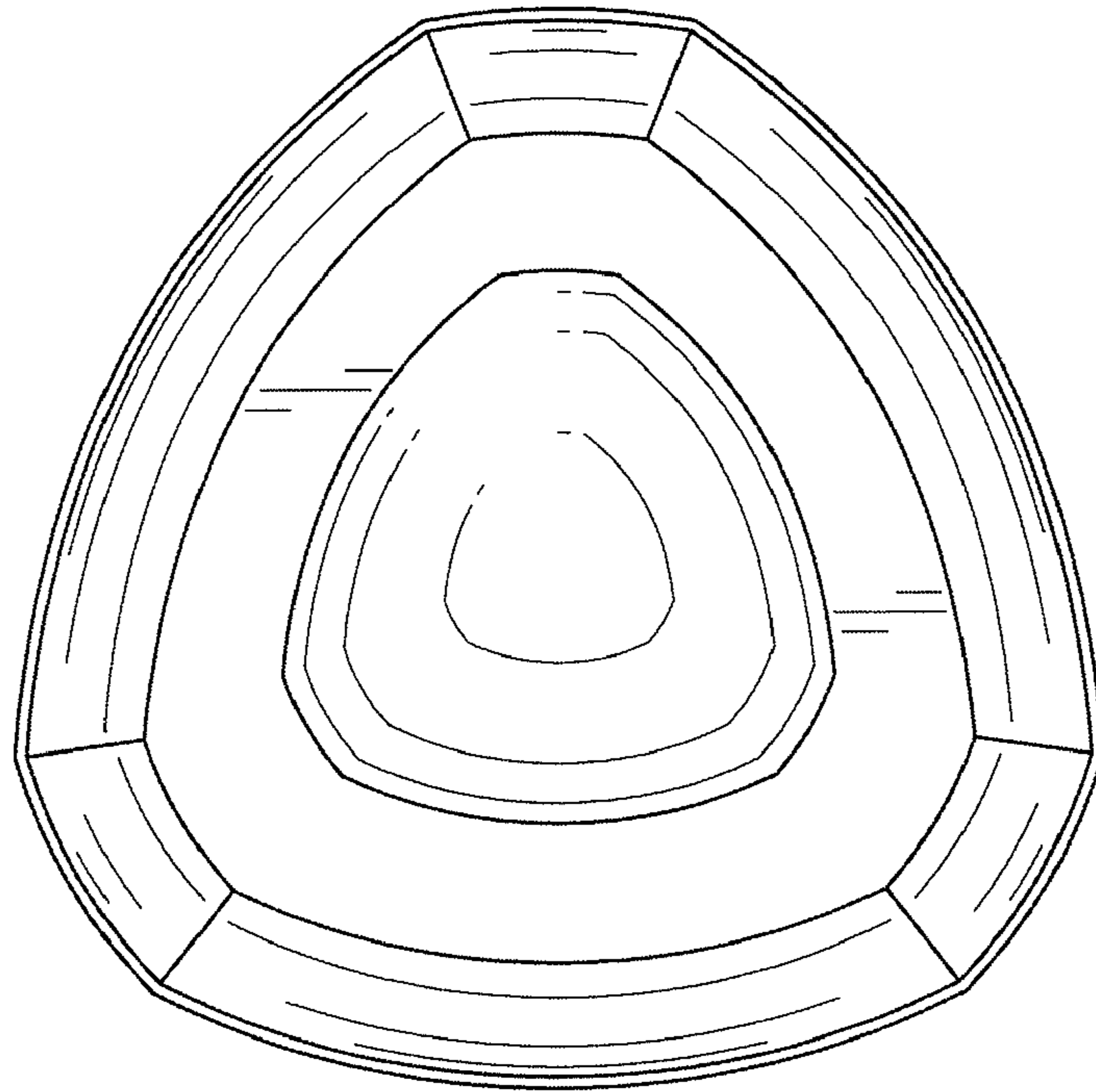

FIG. 6

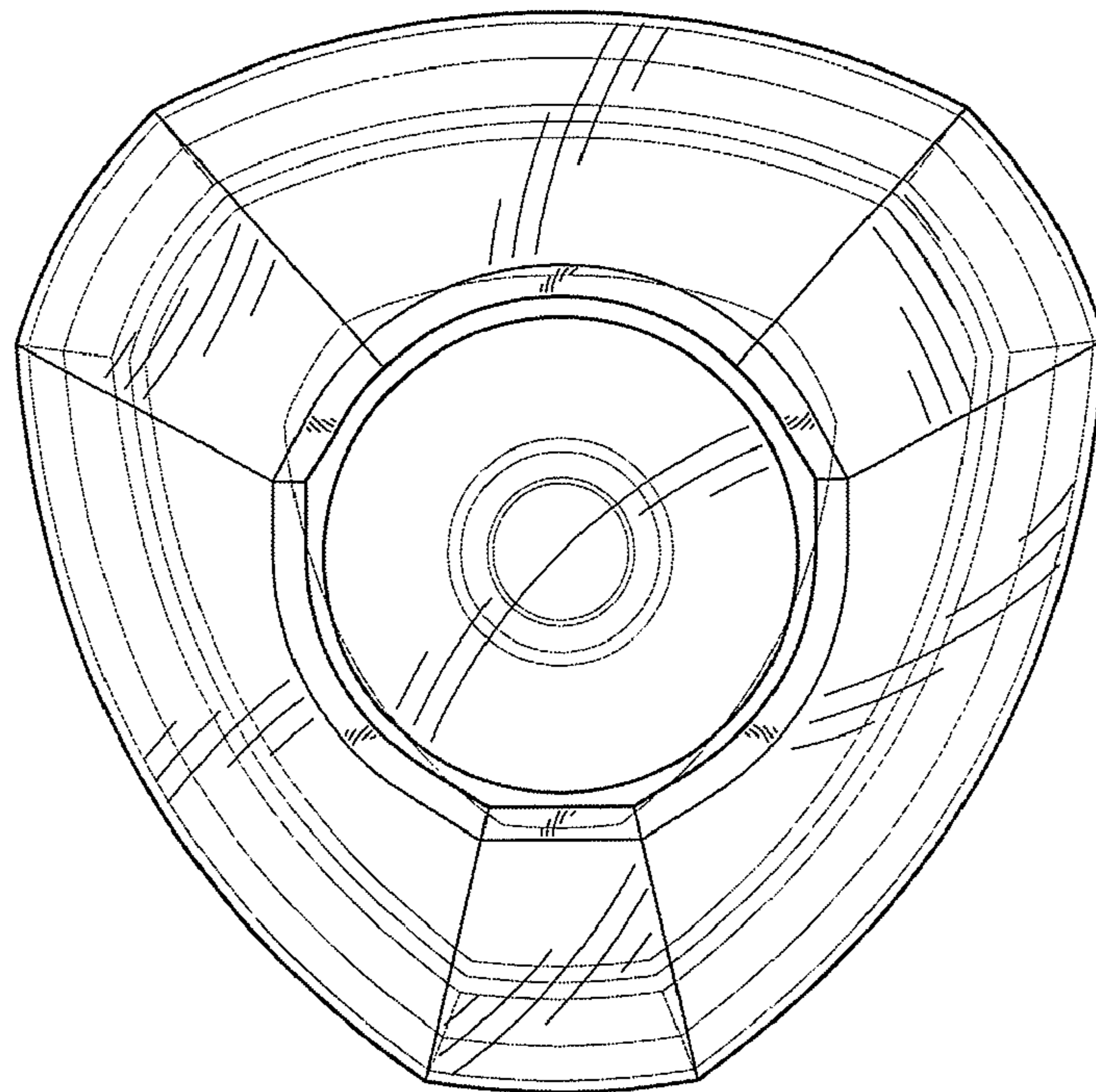

FIG. 7