



US00D626384S

(12) **United States Design Patent**
Zorovich et al.

(10) **Patent No.:** **US D626,384 S**
(45) **Date of Patent:** **** Nov. 2, 2010**

(54) **COMESTIBLE MAKER**

(75) Inventors: **Kenneth D. Zorovich**, Hoboken, NJ (US); **Yos Kumthampinij**, Edgewater, NJ (US); **John C. Earle**, Annapolis, MD (US)

(73) Assignee: **Propeller, Inc.**, Hoboken, NJ (US)

(**) Term: **14 Years**

(21) Appl. No.: **29/360,963**

(22) Filed: **May 4, 2010**

Related U.S. Application Data

(63) Continuation-in-part of application No. 12/321,237, filed on Jan. 16, 2009.

(51) **LOC (9) Cl.** **07-04**

(52) **U.S. Cl.** **D7/672**

(58) **Field of Classification Search** D7/672-677, D7/354, 323, 368, 669; 425/118, 26.2, DIG. 249; 294/87.11; 249/91, 92, 93, 121, 119, 133, 249/140; D1/101, 102, 105, 127

See application file for complete search history.

(56) **References Cited**

U.S. PATENT DOCUMENTS

1,505,592	A	8/1924	Epperson	
1,987,945	A *	1/1935	Schnaler	249/92
2,541,814	A	2/1951	Gaddini	
2,591,261	A *	4/1952	Holahan	249/92
2,946,207	A *	7/1960	Hulterstrum	249/92
3,780,536	A	12/1973	Fishman et al.	
4,239,175	A *	12/1980	Straubinger	249/92
4,352,830	A	10/1982	Billett et al.	
4,688,398	A	8/1987	Baek	
4,696,166	A	9/1987	Bukoschek et al.	
5,354,191	A *	10/1994	Bobis	425/118
D592,911	S *	5/2009	Buchanan	

OTHER PUBLICATIONS

U.S. Appl. NO. 12/321,237, filed Jan. 16, 2009 titled Method and Apparatus for Making Frozen Comestibles.

* cited by examiner

Primary Examiner—Terry A Wallace

(74) *Attorney, Agent, or Firm*—Greenberg Traurig, LLP

(57) **CLAIM**

The ornamental design for a comestible maker, as shown and described.

DESCRIPTION

FIG. 1 is a perspective view of a comestible maker showing a first embodiment of our new design;

FIG. 2 is a top plan view of the comestible maker shown in FIG. 1;

FIG. 3 is a left side elevational view of the comestible maker shown in FIG. 1, the right side elevational view being a mirror image of FIG. 3;

FIG. 4 is a front elevational view of the comestible maker shown in FIG. 1, the rear elevational view being a mirror image of FIG. 4;

FIG. 5 is a bottom plan view of the comestible maker shown in FIG. 1;

FIG. 6 is a perspective view of a comestible maker showing a second embodiment of our new design;

FIG. 7 is a top plan view of the comestible maker shown in FIG. 6;

FIG. 8 is a left side elevational view of the comestible maker shown in FIG. 6, the right side elevational view being a mirror image of FIG. 8;

FIG. 9 is a front elevational view of the comestible maker shown in FIG. 6, the rear elevational view being a mirror image of FIG. 9;

FIG. 10 is a bottom plan view of the comestible maker shown in FIG. 6;

FIG. 11 is a perspective view of a comestible maker showing a third embodiment of our new design;

FIG. 12 is a top plan view of the comestible maker shown in FIG. 11;

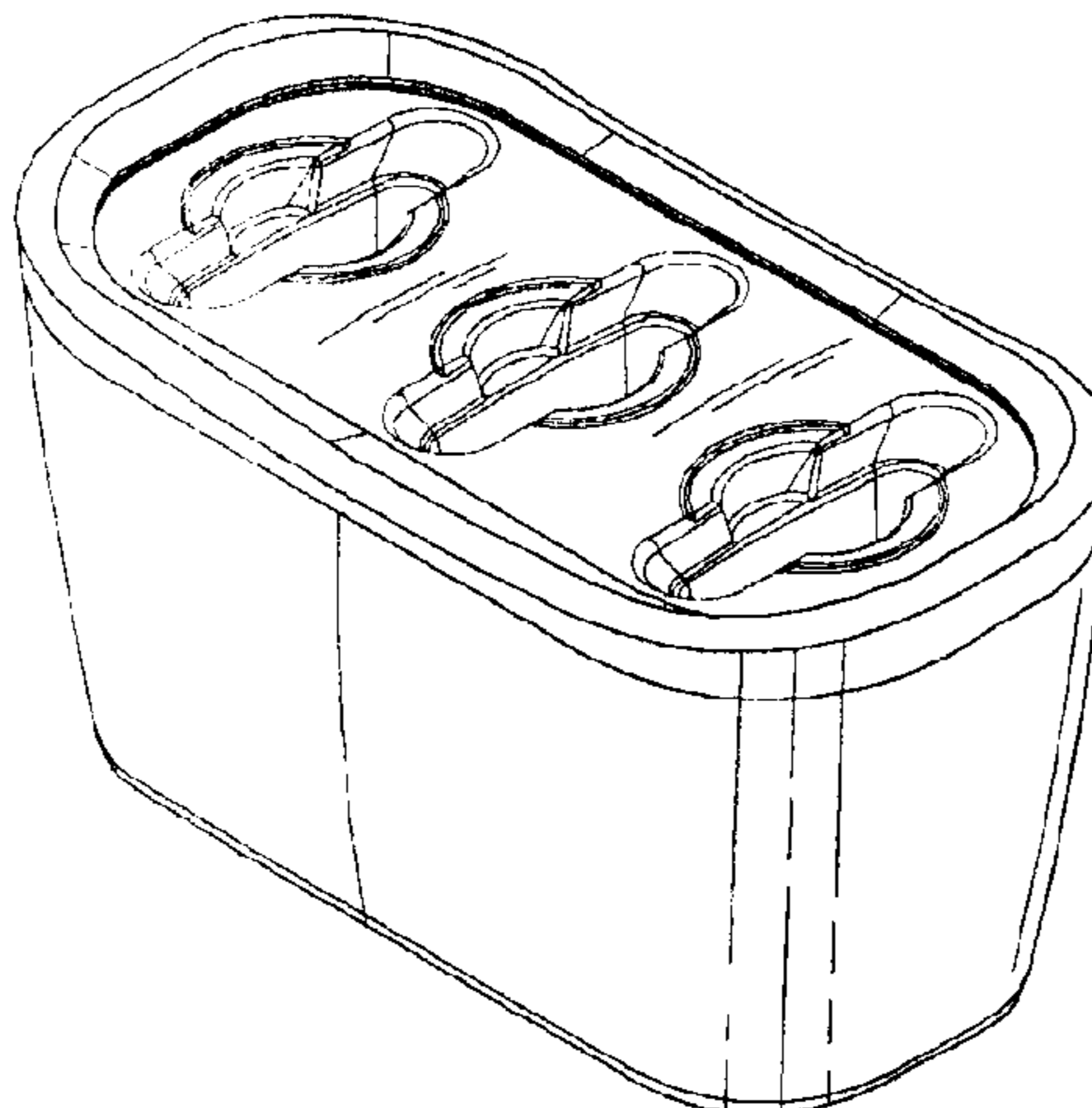

FIG. **13** is a left side elevational view of the comestible maker shown in FIG. **11**, the right side elevational view being a mirror image of FIG. **13**;

FIG. **14** is a front elevational view of the comestible maker shown in FIG. **11**, the rear elevational view being a mirror image of FIG. **14**;

FIG. **15** is a bottom plan view of the comestible maker shown in FIG. **11**;

FIG. **16** is a perspective view of a comestible maker showing a fourth embodiment of our new design;

FIG. **17** is a top plan view of the comestible maker shown in FIG. **16**;

FIG. **18** is a front elevational view of the comestible maker shown in FIG. **16**, the rear, left side and right side elevational views all being mirror images of FIG. **18**; and,

FIG. **19** is a bottom plan view of the comestible maker shown in FIG. **16**.

1 Claim, 8 Drawing Sheets

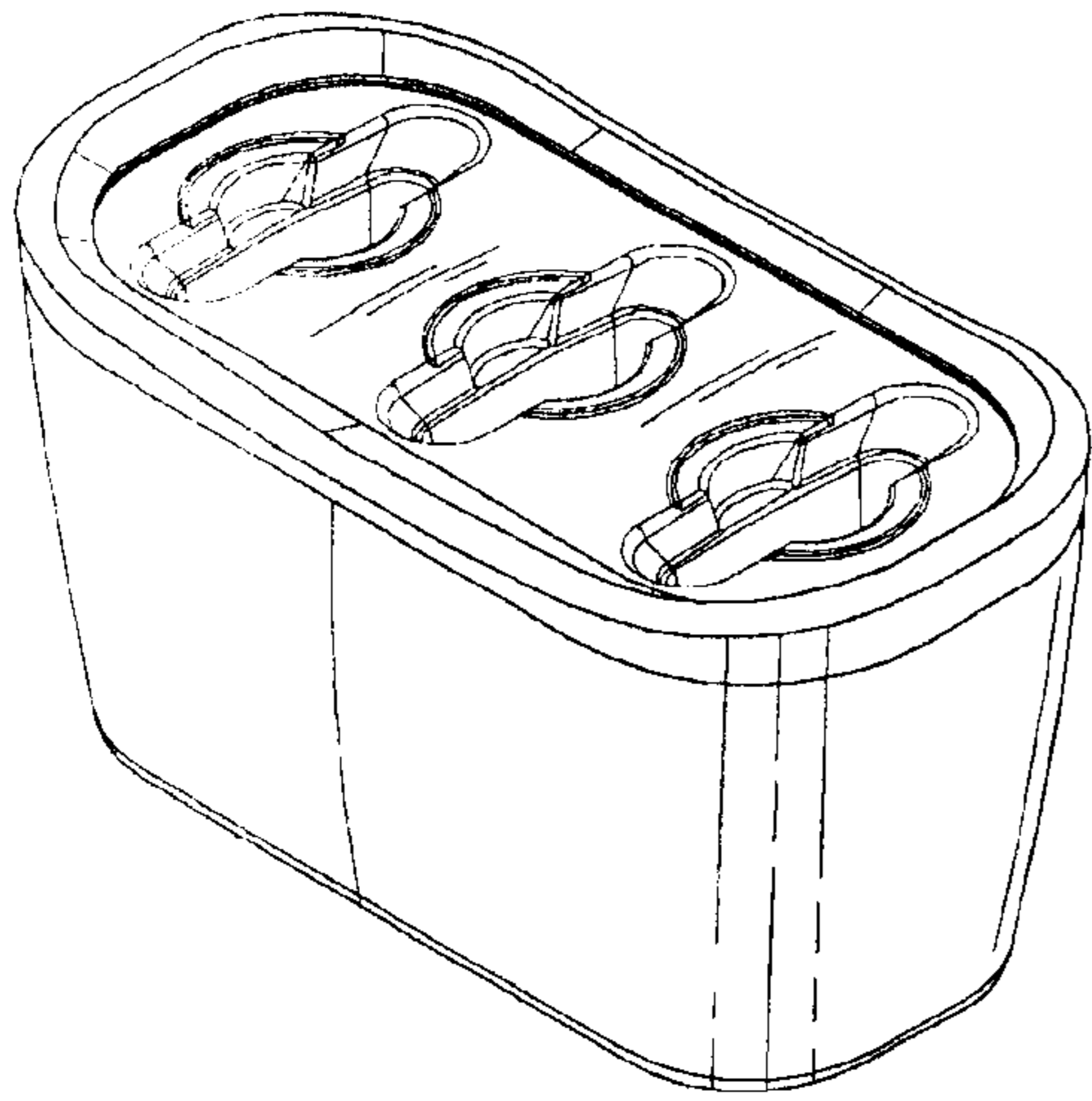

FIG. 1

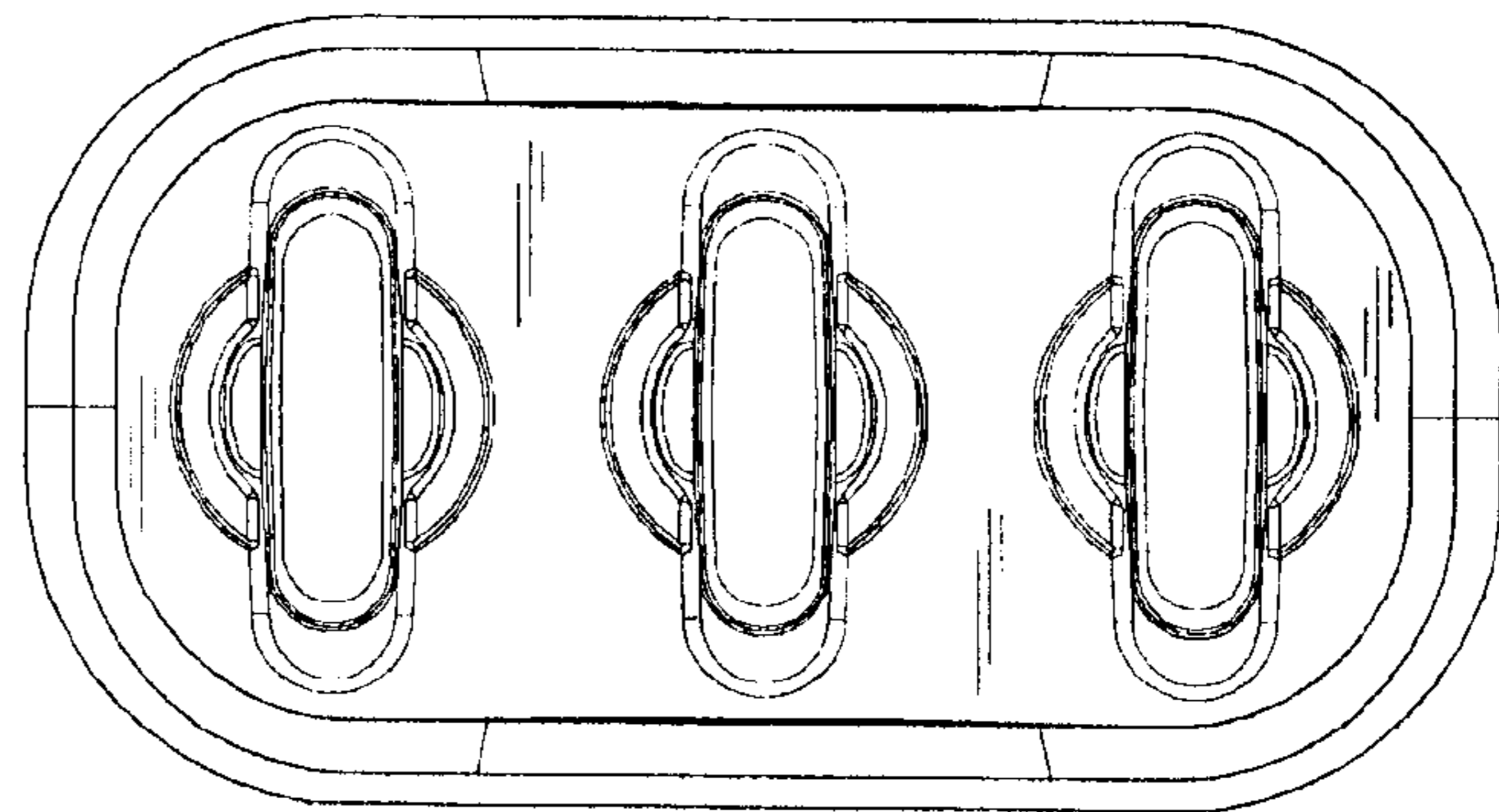

FIG. 2

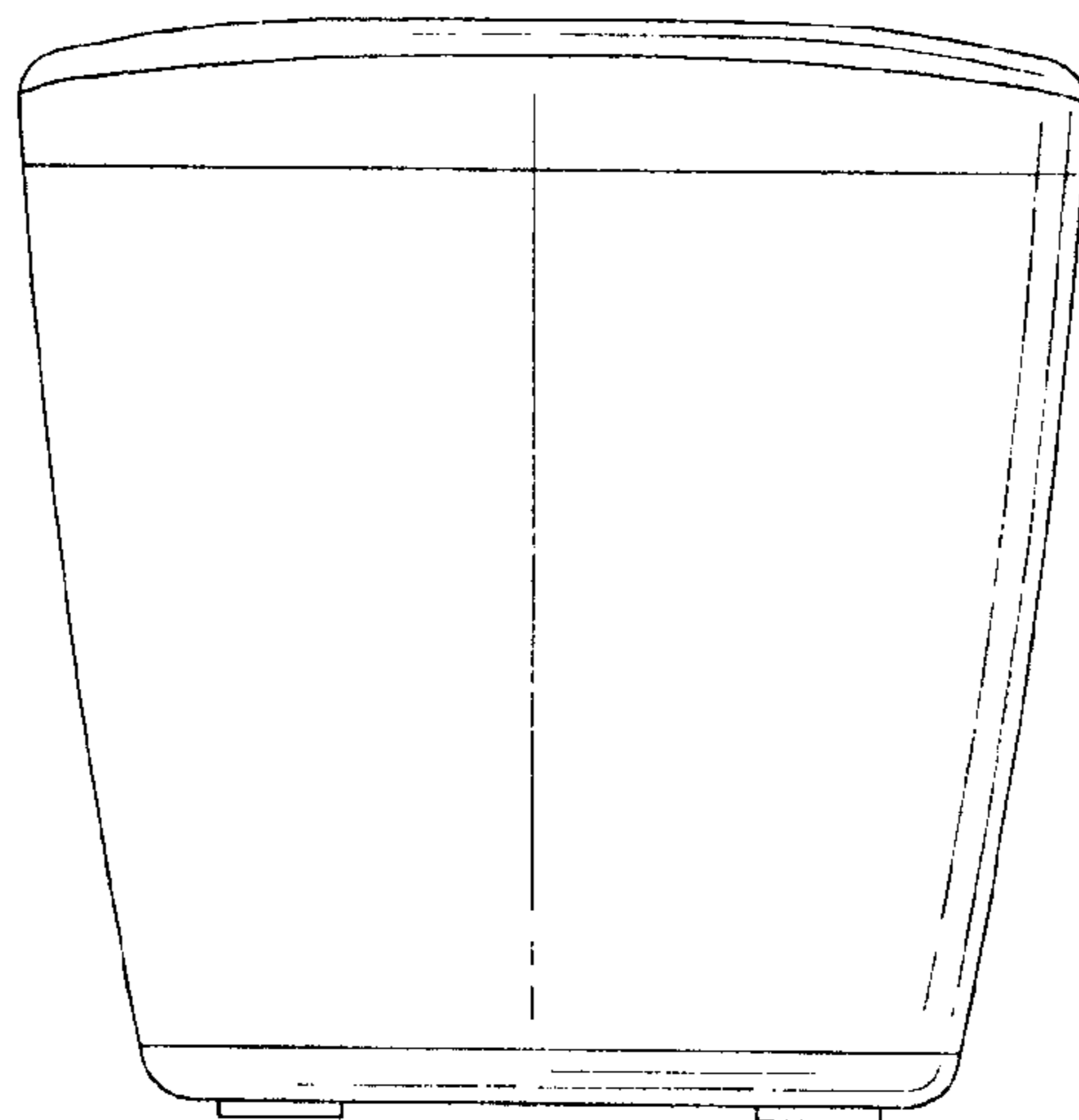

FIG. 3

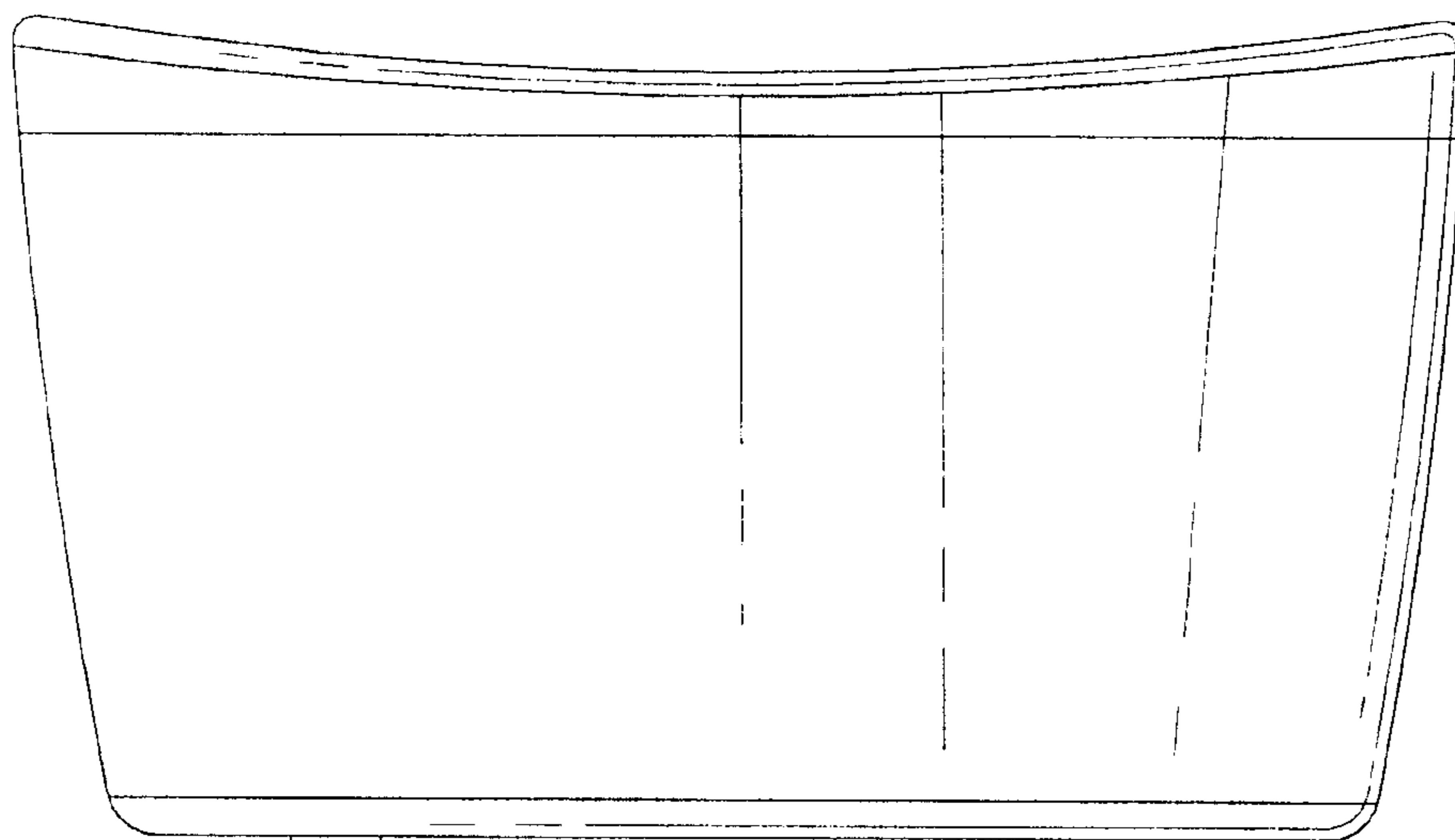

FIG. 4

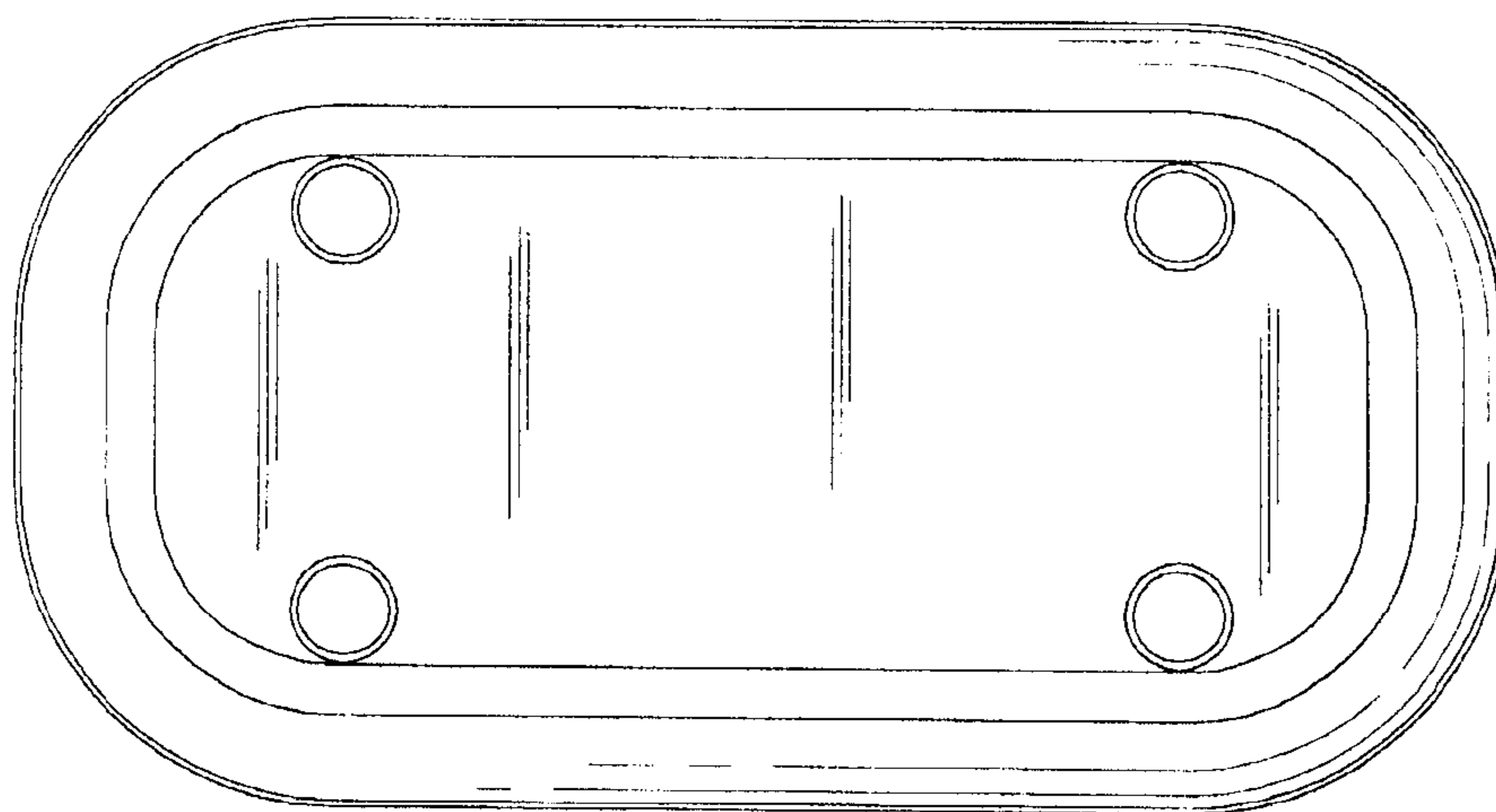

FIG. 5

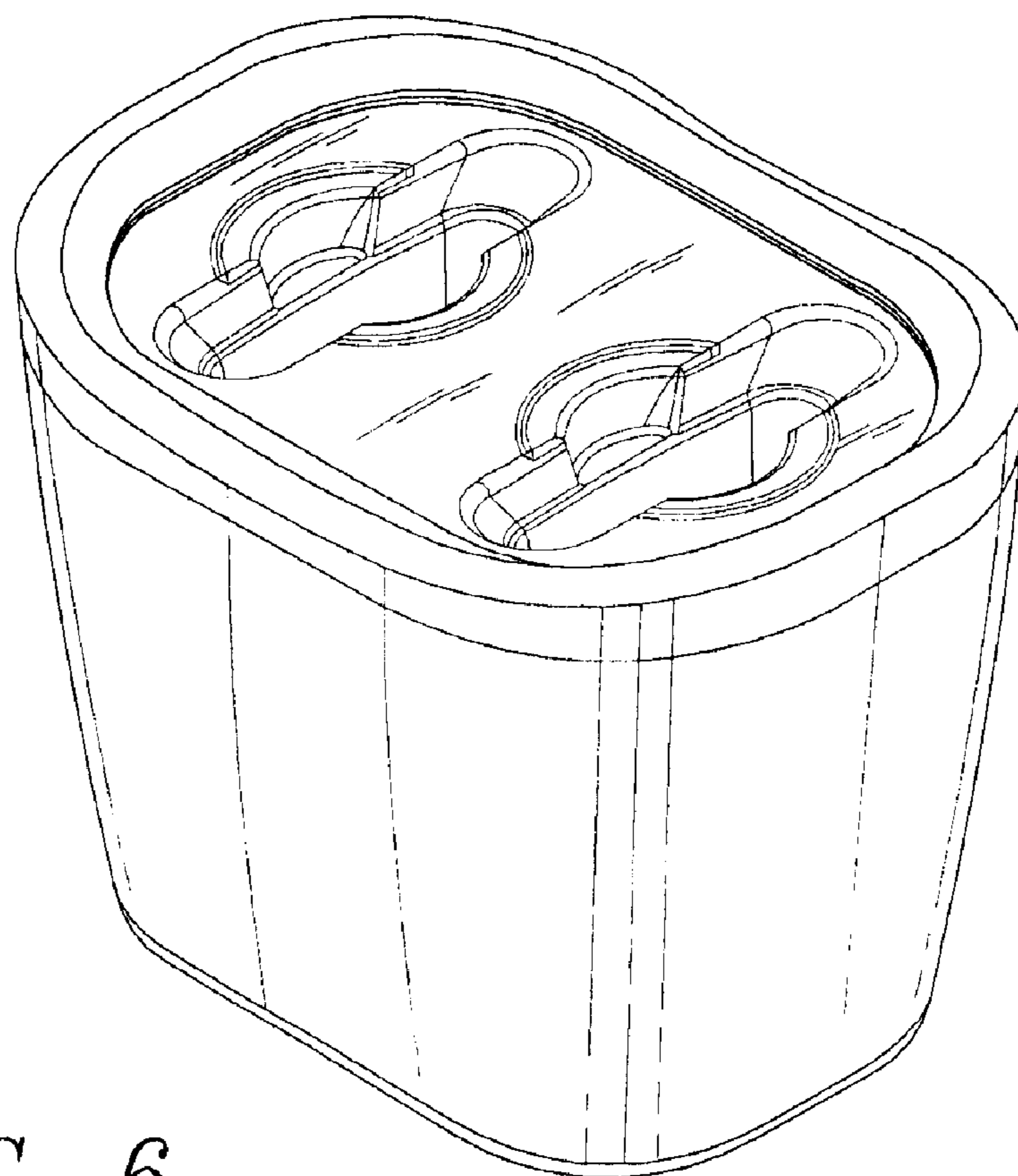

FIG. 6

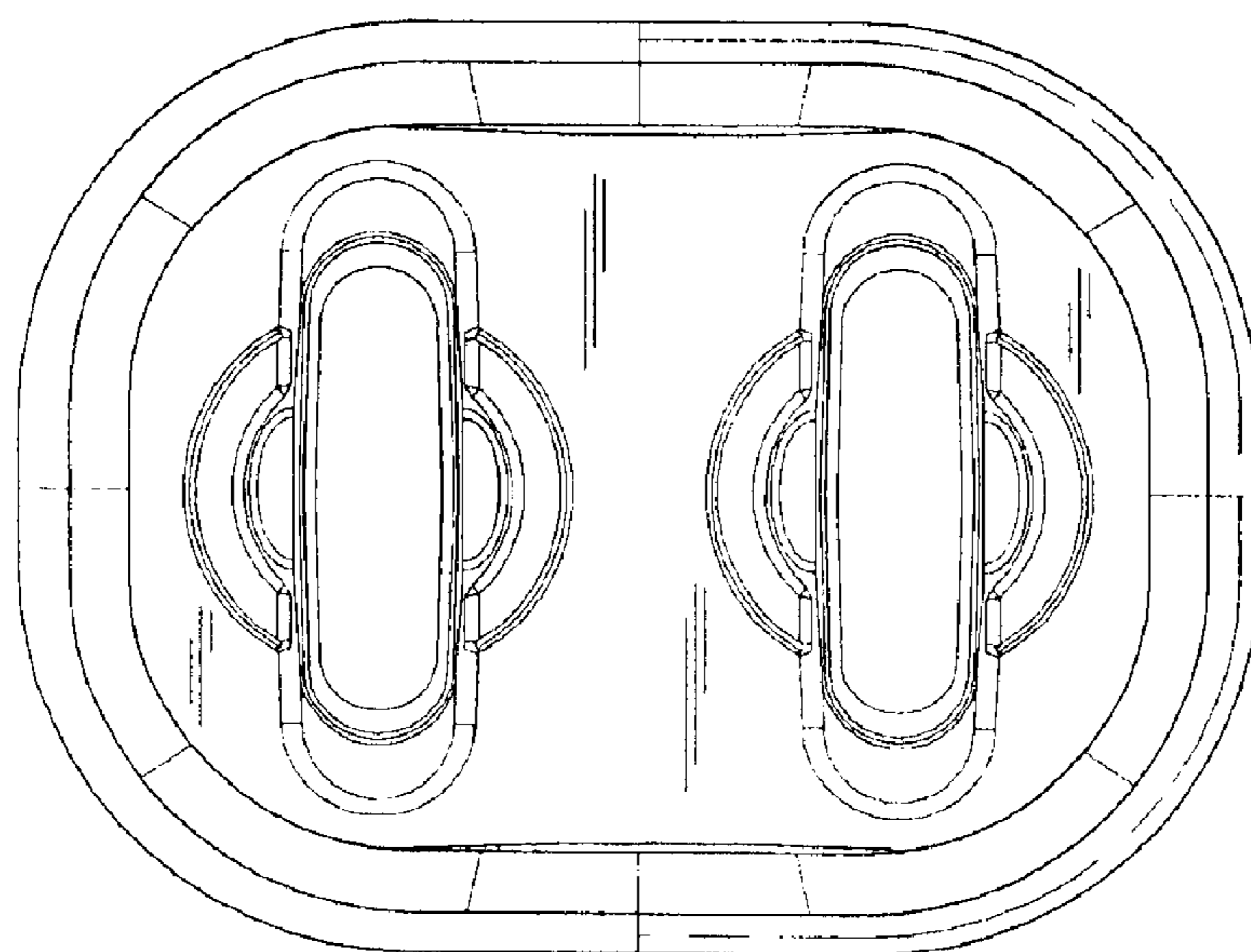

FIG. 7

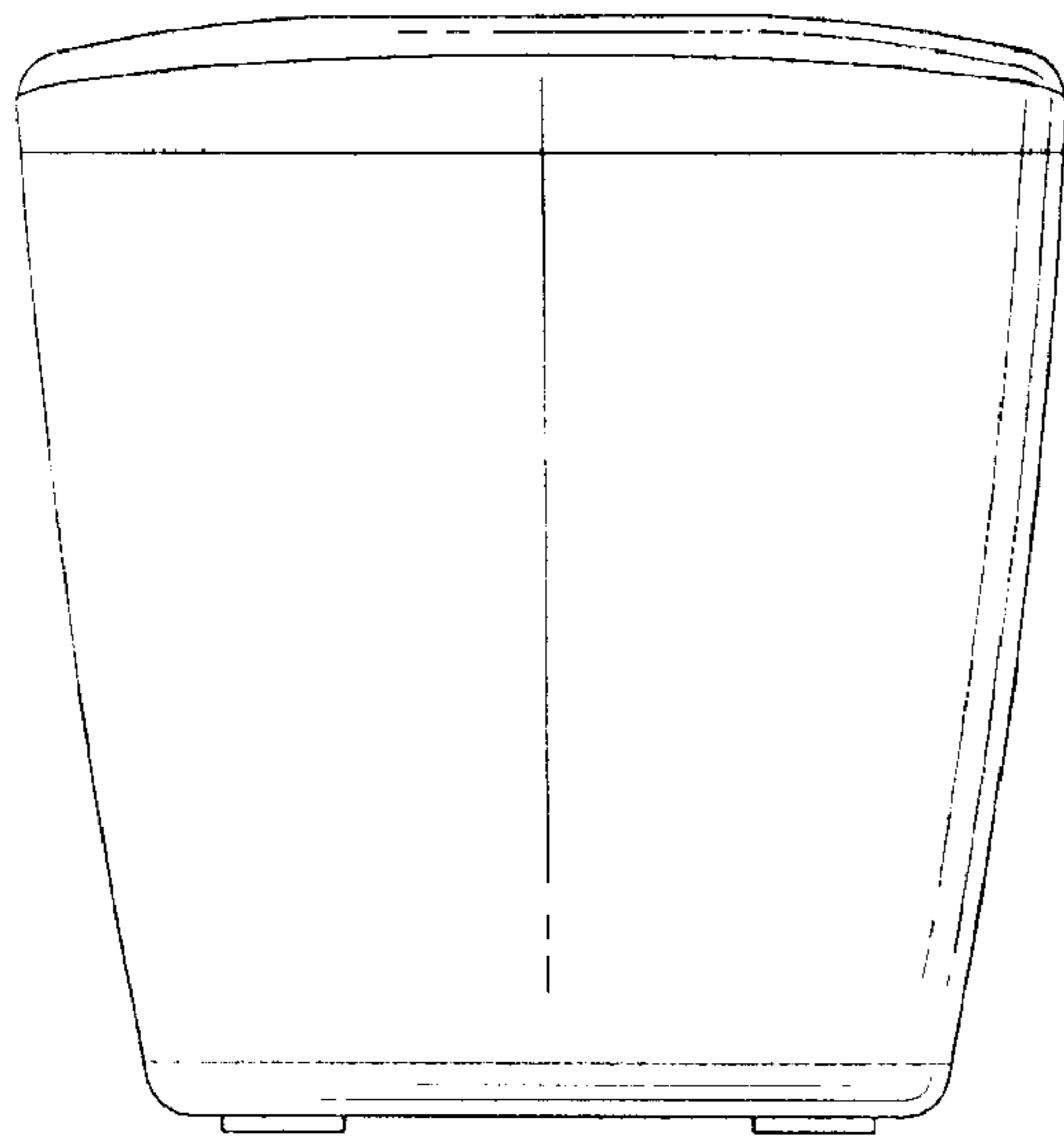

FIG. 8

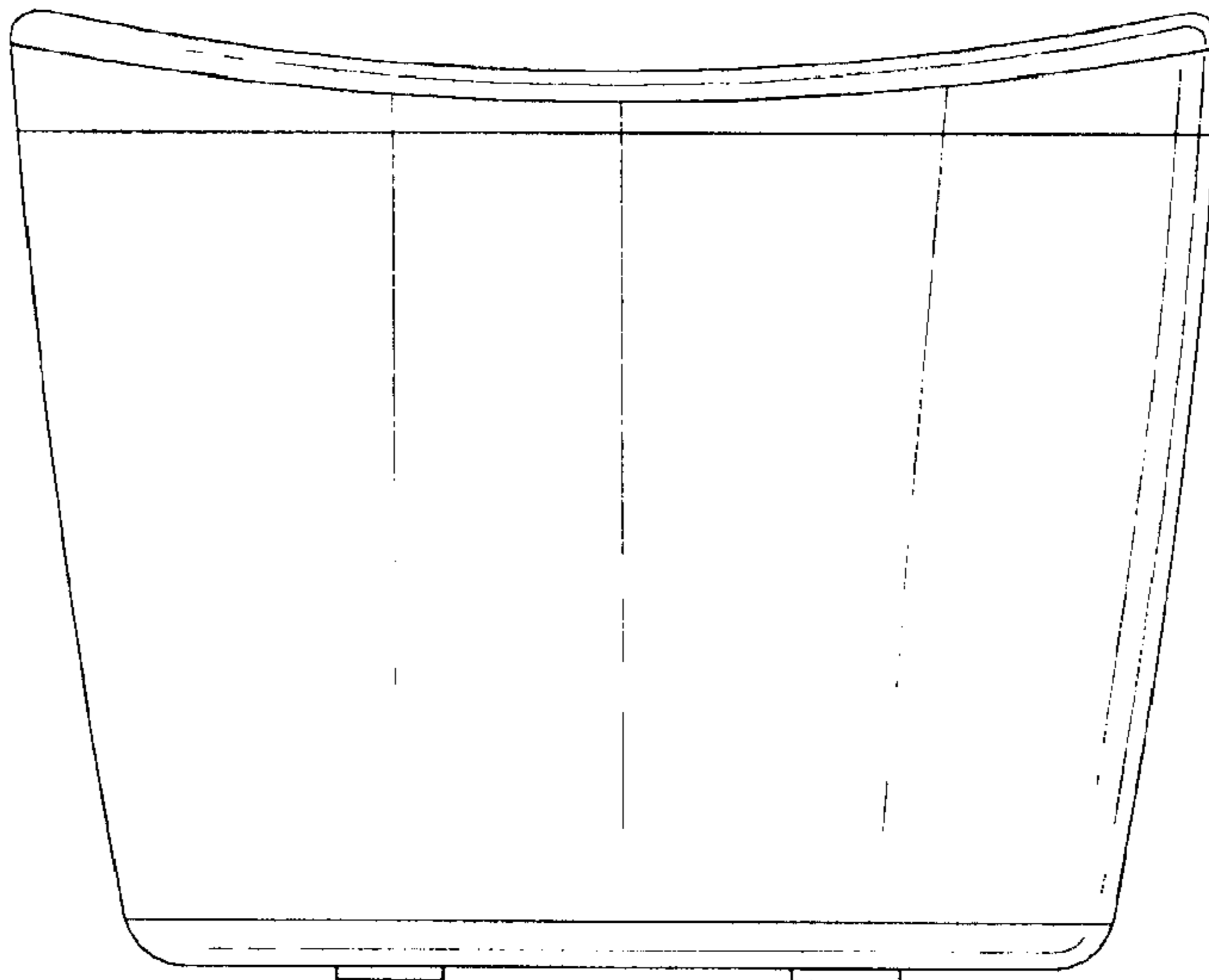

FIG. 9

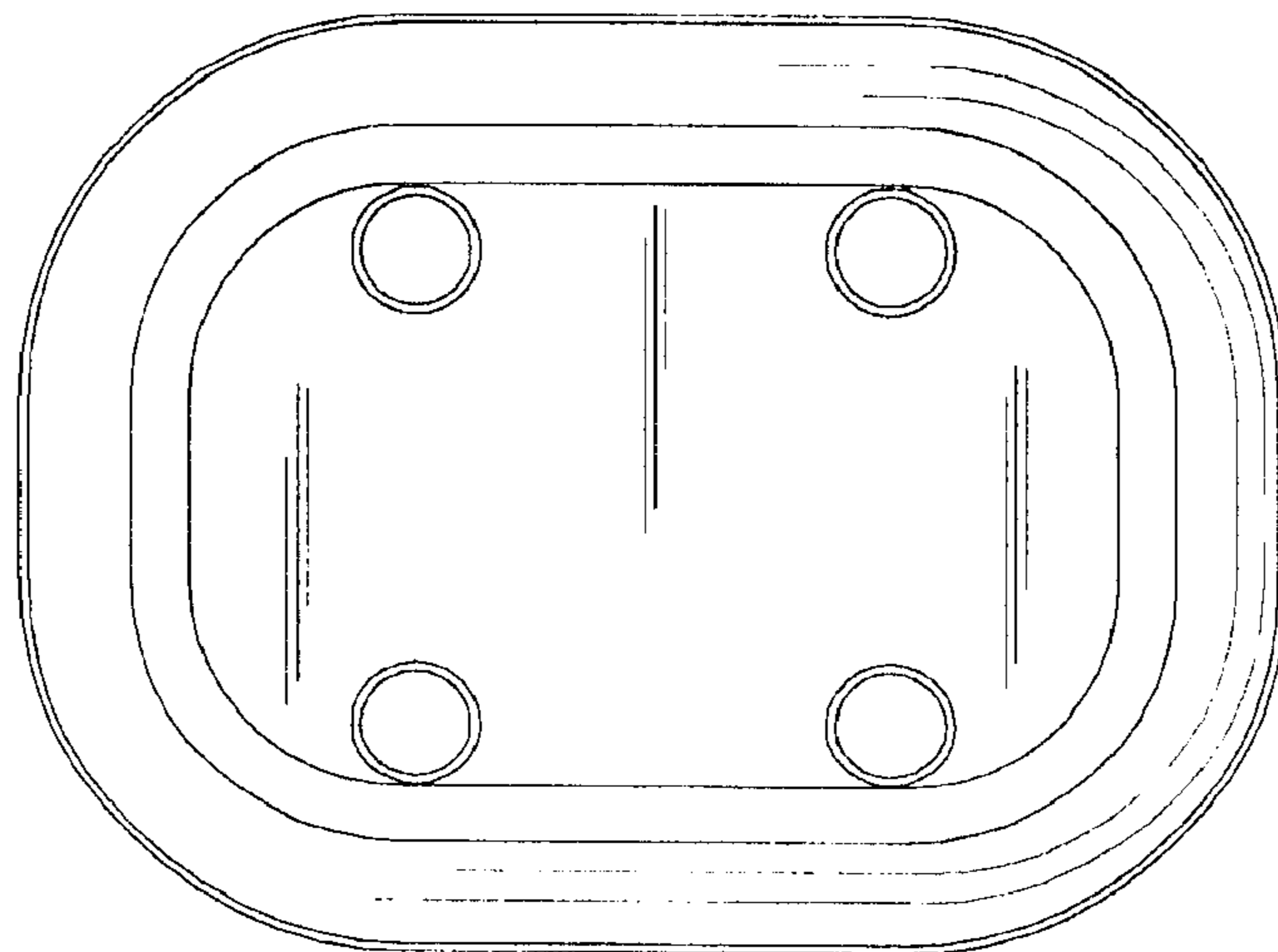

FIG. 10

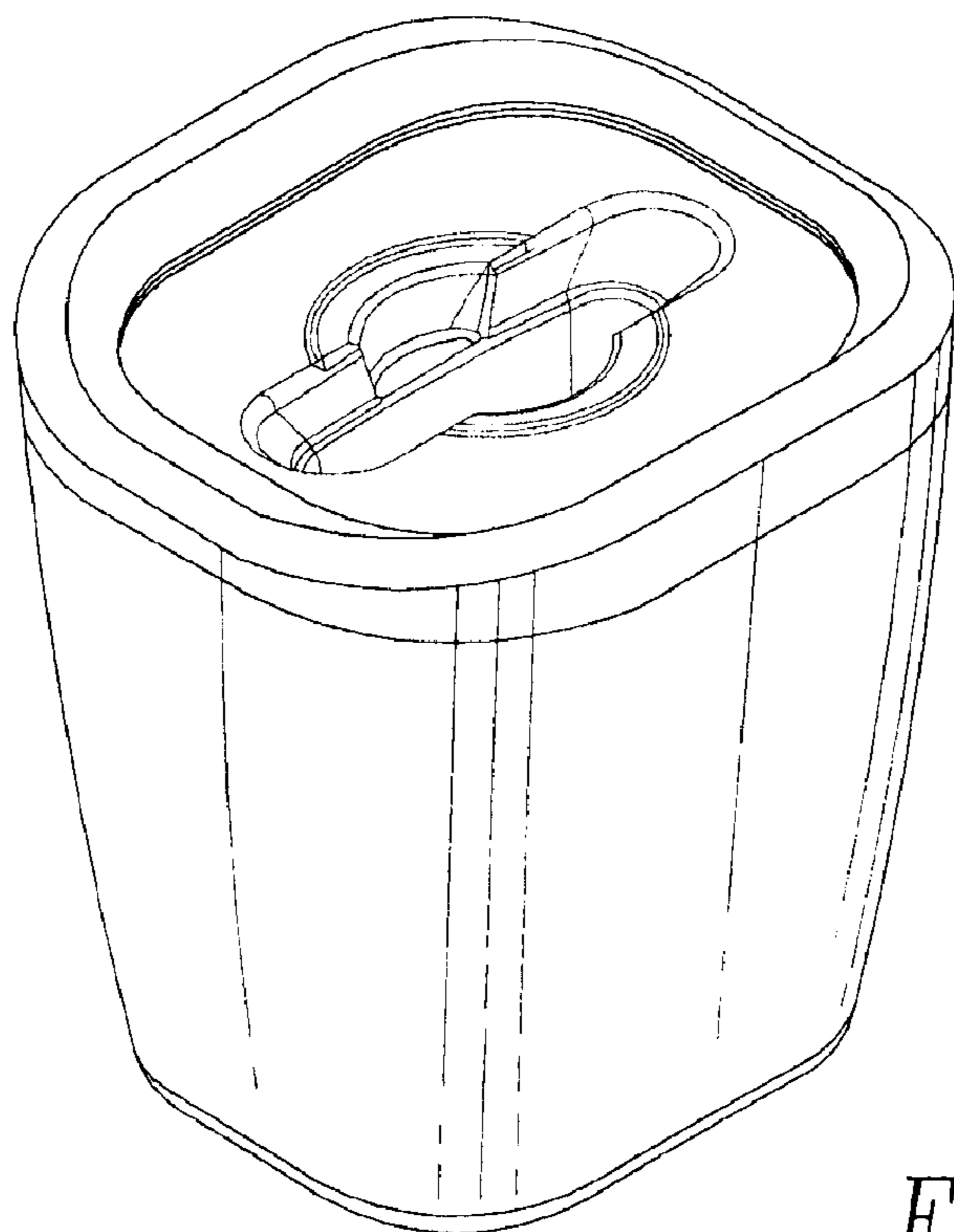

FIG. 11

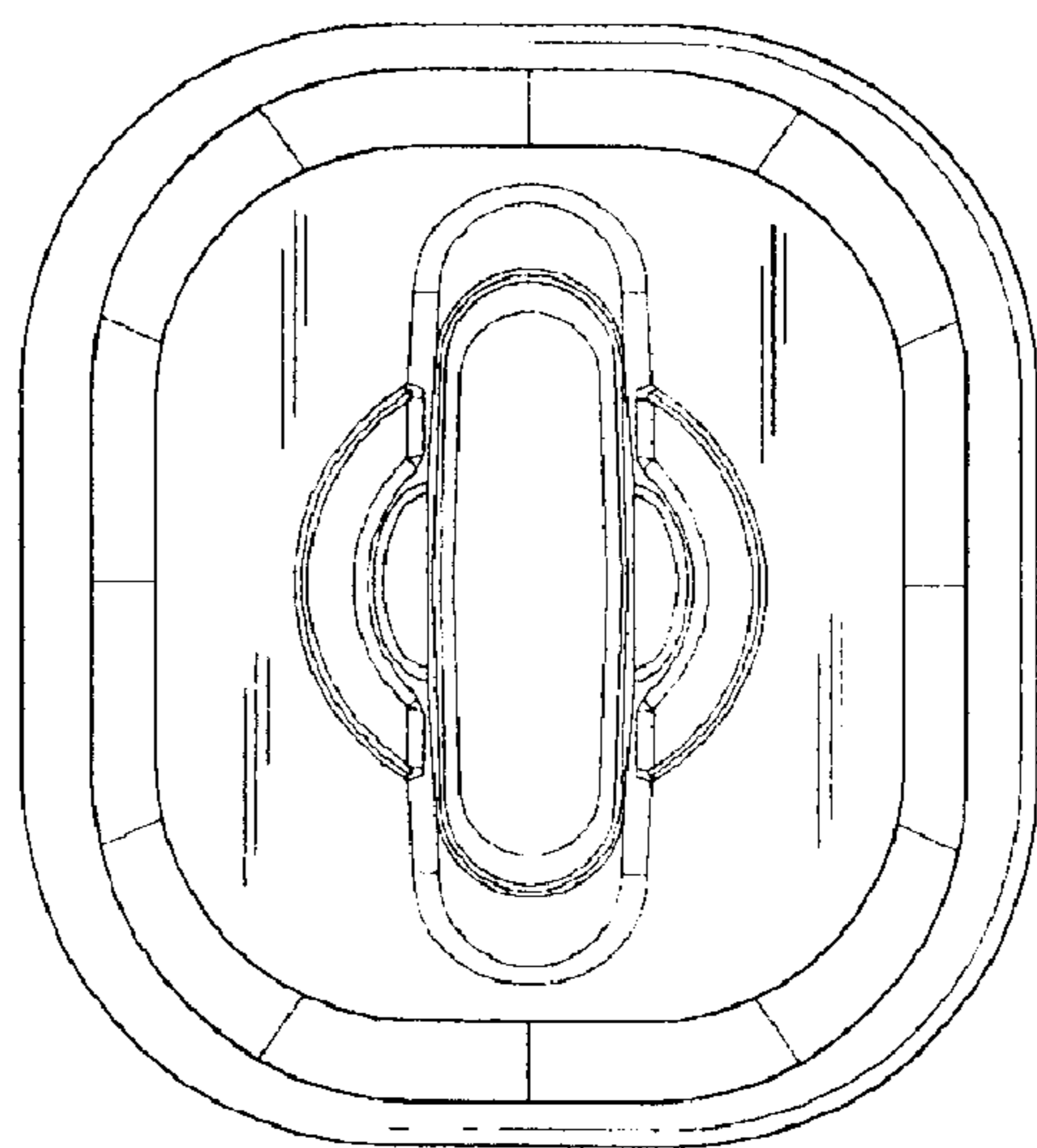

FIG. 12

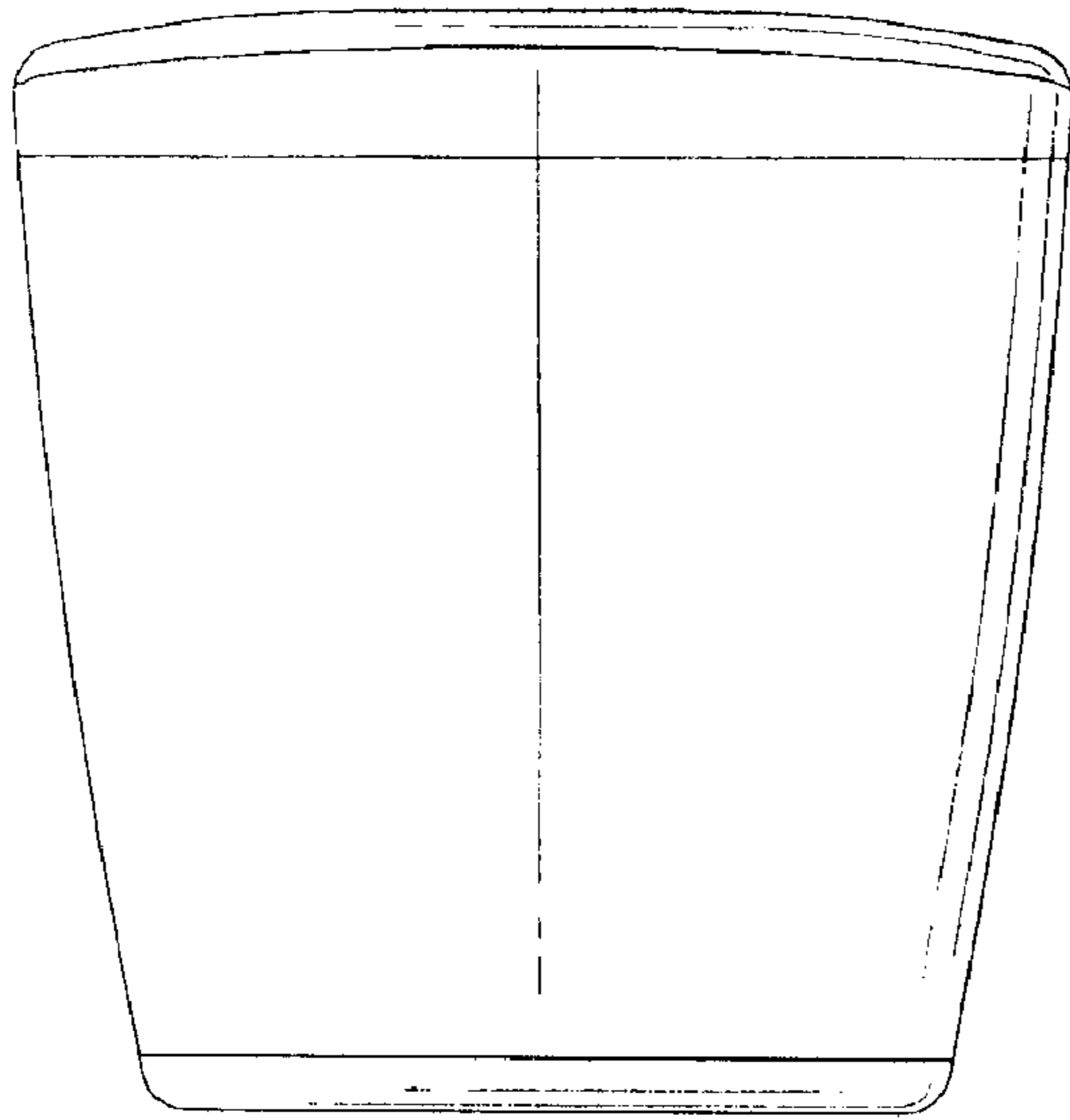

FIG. 13

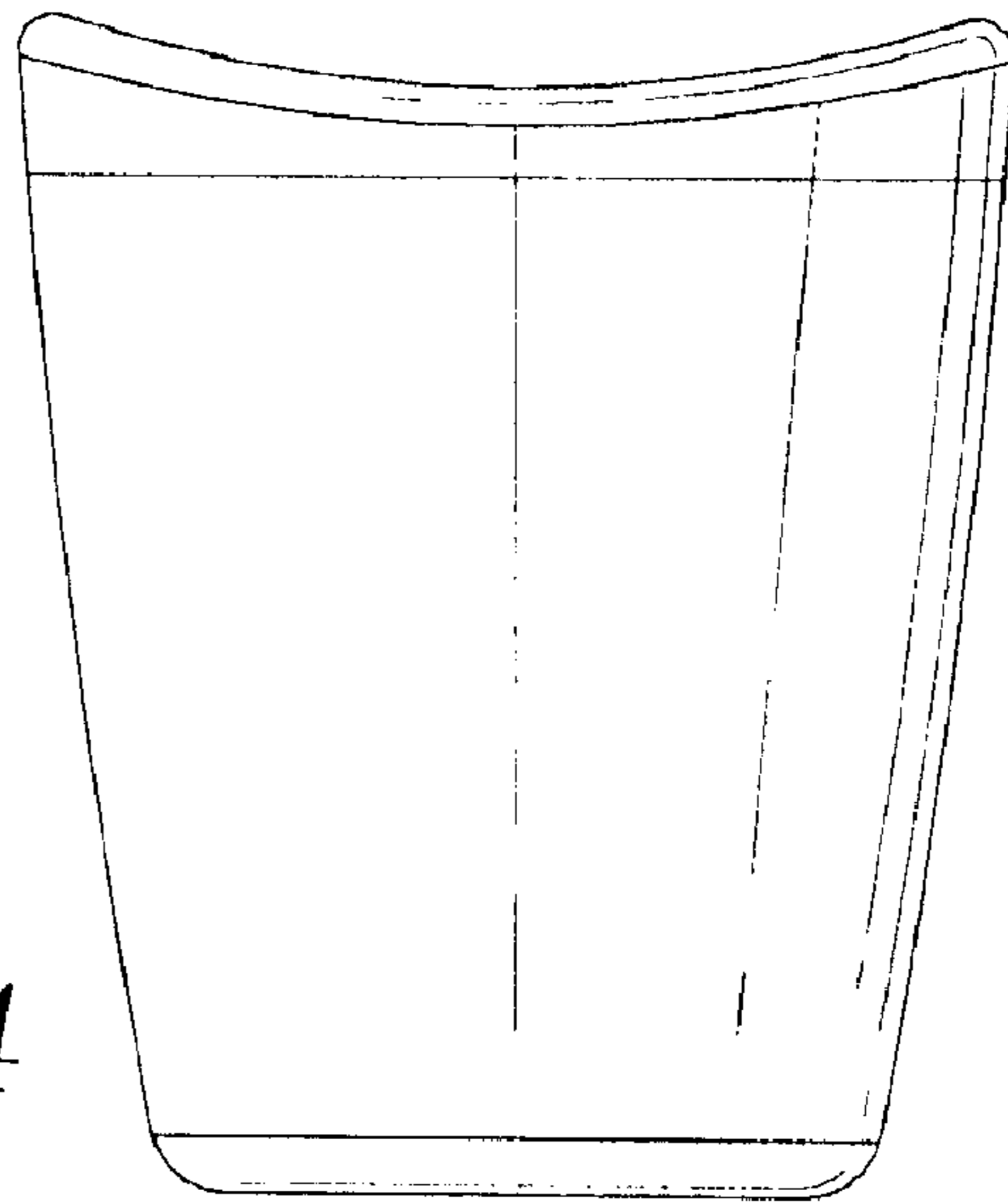

FIG. 14

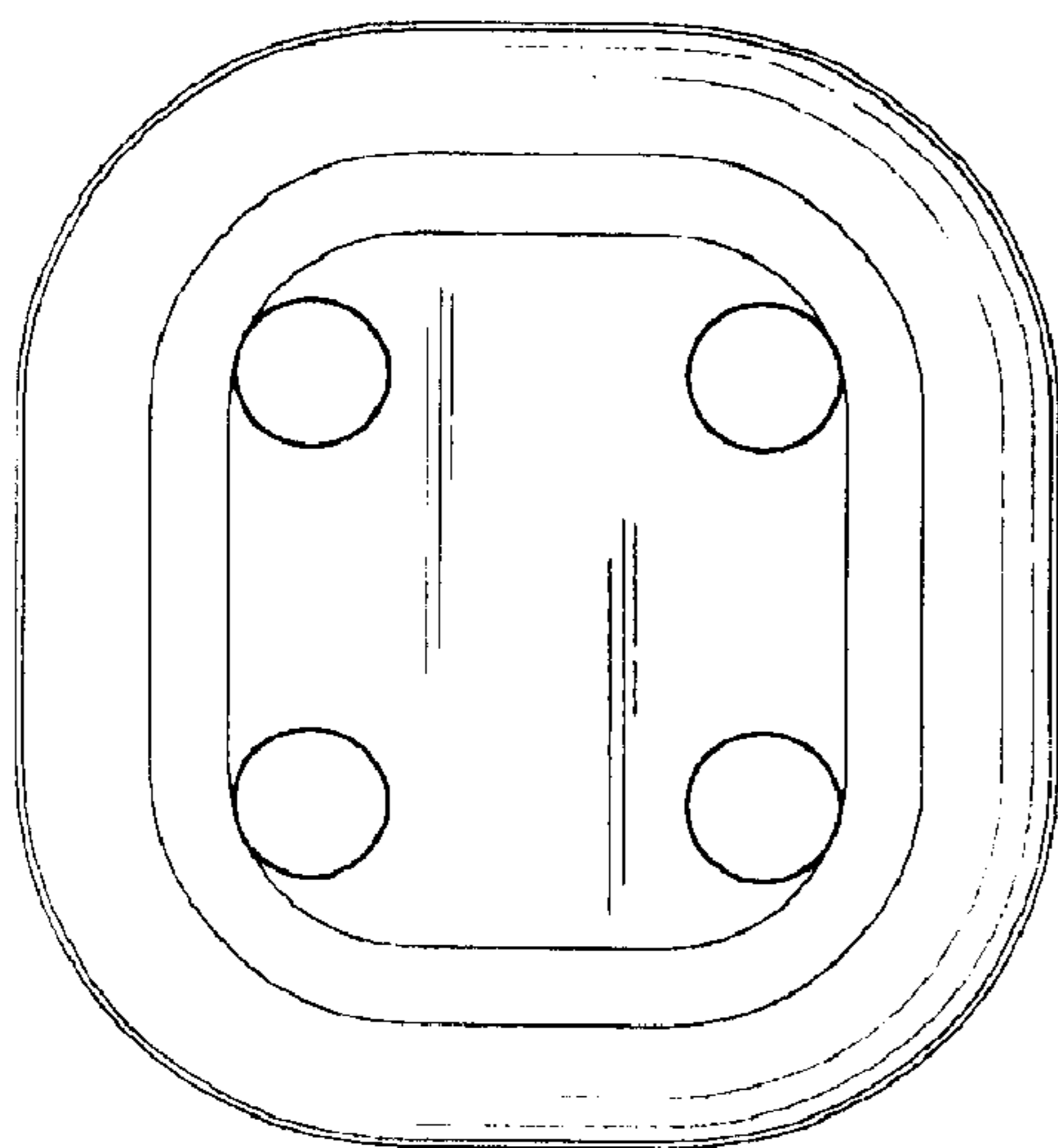

FIG. 15

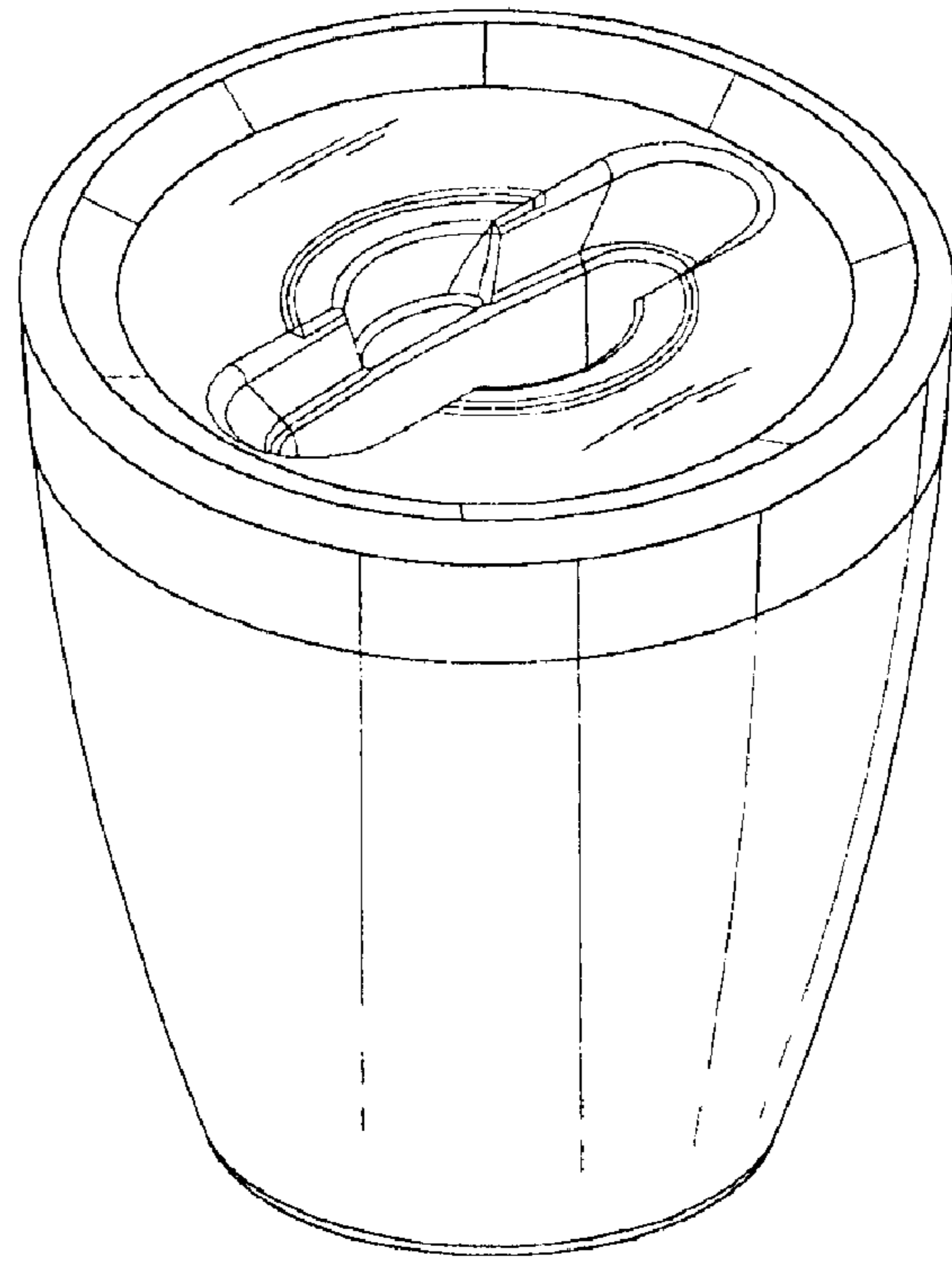

FIG. 16

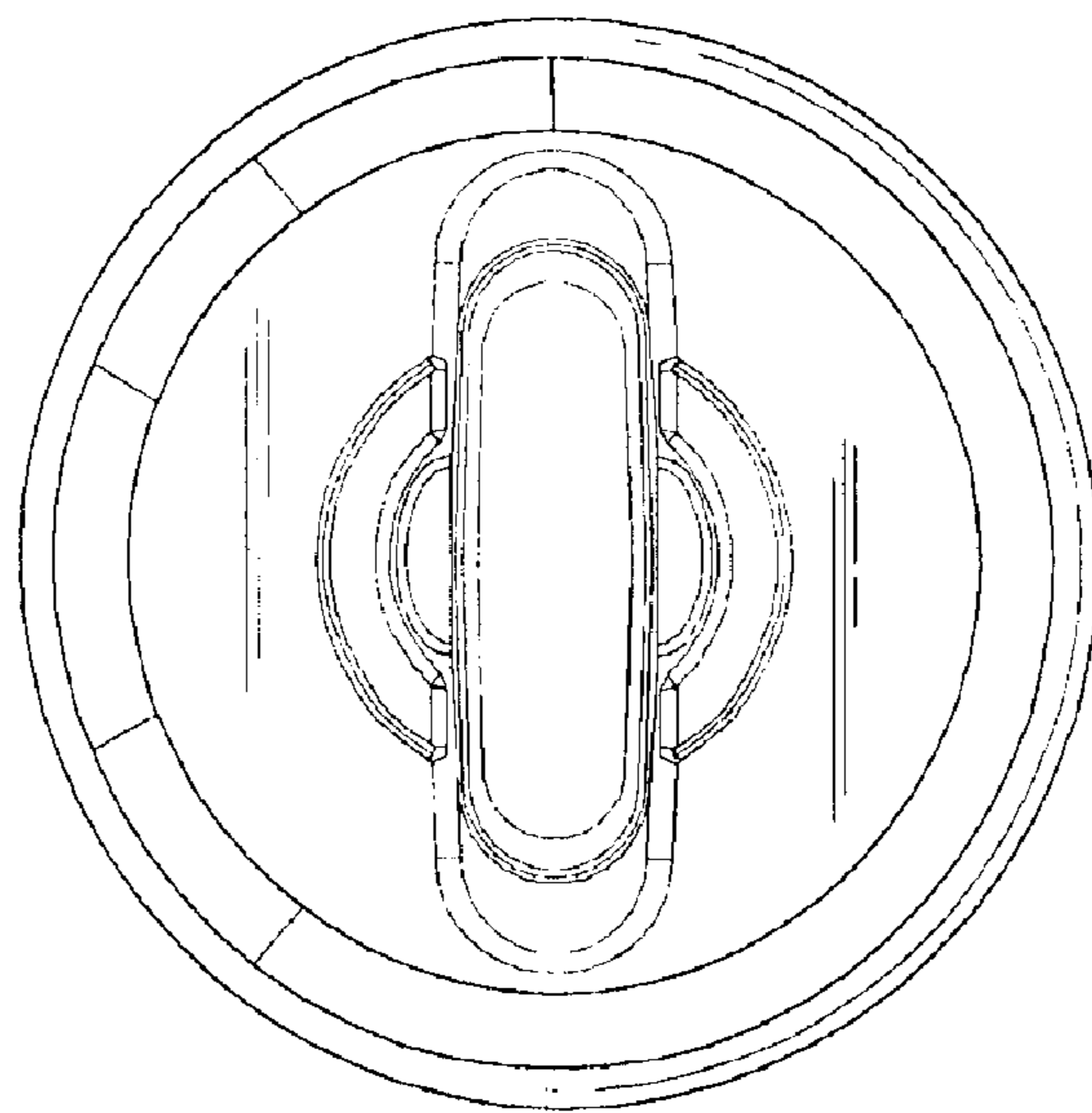

FIG. 17

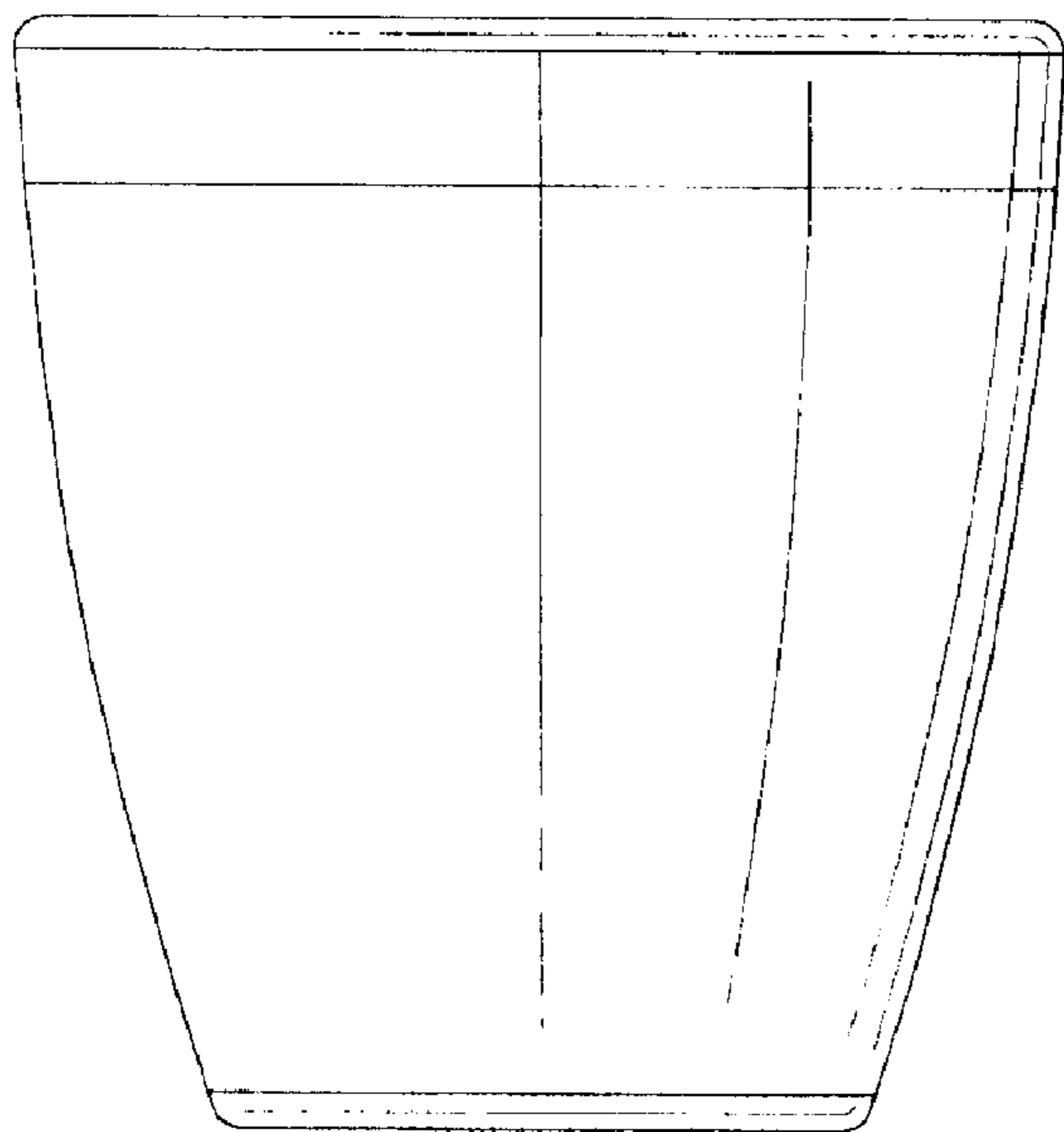

FIG. 18

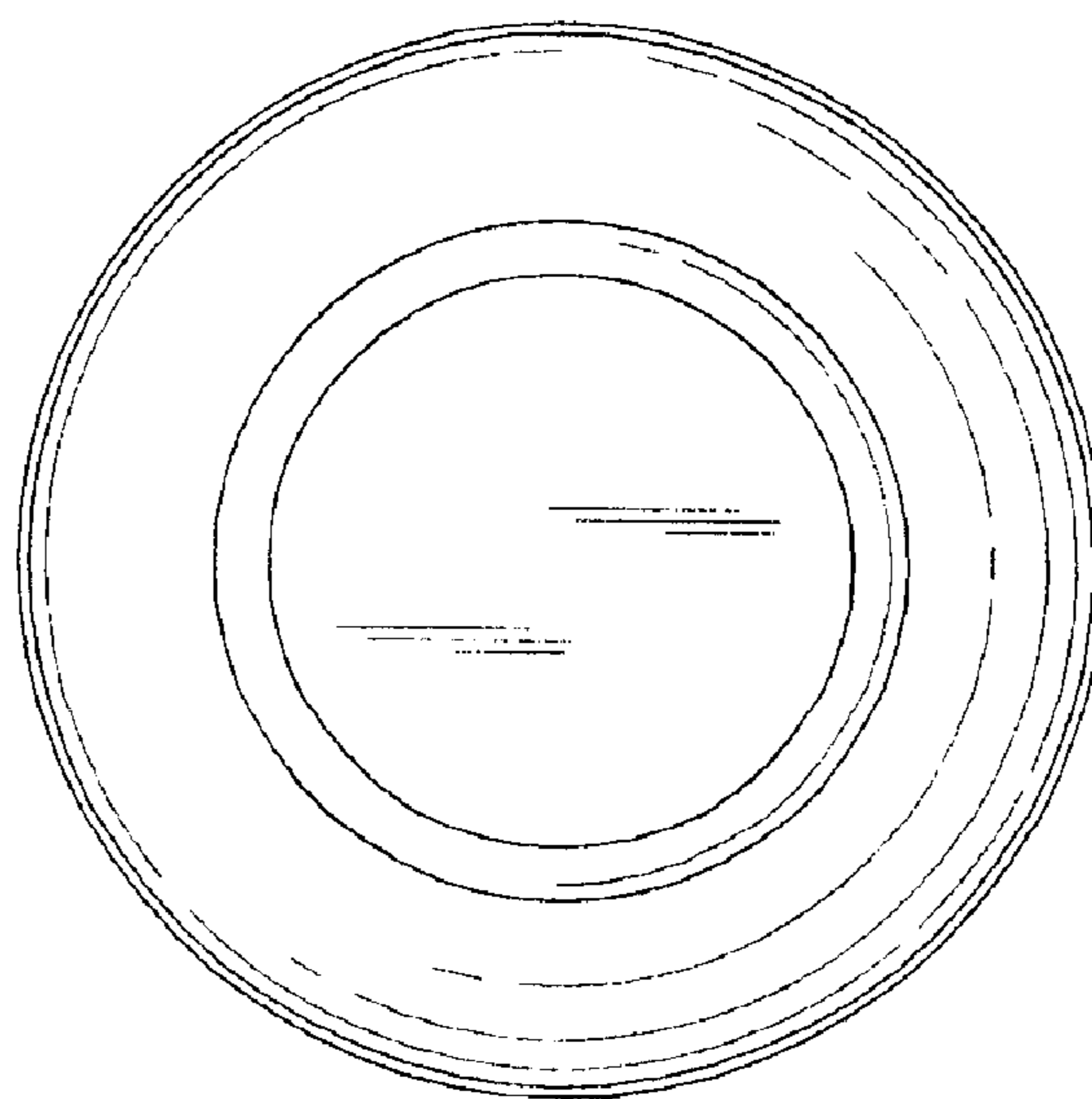

FIG. 19