



US00D626360S

(12) **United States Design Patent**
Galati, Jr. et al.

(10) **Patent No.:** **US D626,360 S**
(45) **Date of Patent:** **** Nov. 2, 2010**

- (54) **FOOT SPA BASE**
- (75) Inventors: **Joseph J. Galati, Jr.**, Brookfield, WI (US); **John Meyerovich**, Bal Harbour, FL (US)
- (73) Assignee: **Continuum Footspas, LLC**, New Berlin, WI (US)
- (**) Term: **14 Years**
- (21) Appl. No.: **29/348,562**
- (22) Filed: **Jan. 19, 2010**

- 5,593,212 A 1/1997 Praria et al.
- D391,408 S 3/1998 Lee
- D424,819 S 5/2000 Galati, Jr. et al.
- D429,380 S 8/2000 Fontier et al.
- D434,916 S 12/2000 Galati, Jr. et al.
- D435,371 S 12/2000 Galati, Jr. et al.
- 6,230,345 B1 5/2001 Borrero et al.
- D450,390 S 11/2001 Tran
- 6,503,212 B2 1/2003 Park
- D479,919 S 9/2003 Genelli et al.
- 6,732,387 B1 5/2004 Waldron
- D498,599 S 11/2004 Luong
- 6,874,184 B2 4/2005 Chandler

(Continued)

- (51) **LOC (9) Cl.** **06-01**
- (52) **U.S. Cl.** **D6/500**
- (58) **Field of Classification Search** D6/330, D6/335-338, 340, 349-355, 358, 359, 364, D6/366, 376, 491, 495, 500-502; 297/16.1, 297/39, 46, 135, 140, 156, 158.3, 158.4, 297/175, 177, 187, 195.1, 195.11, 211, 245, 297/423.1, 423.16, 445.1, 461, 462; D23/277, D23/289; D24/201, 204, 212, 213
See application file for complete search history.

OTHER PUBLICATIONS

AmeriSpa web pages, printed in 2007, 6 pages (<http://www.amerispa.com/main.html>).

(Continued)

Primary Examiner—Sandra Snapp
(74) *Attorney, Agent, or Firm*—Ryan Kromholz & Manion, S.C.

(56) **References Cited**

U.S. PATENT DOCUMENTS

- 1,362,692 A 12/1920 Golstein
- 2,248,369 A 7/1941 Luderson
- 2,473,947 A 6/1949 Hamstrom
- D166,402 S 4/1952 Manne et al.
- D167,675 S 9/1952 Chancellor
- 3,633,967 A 1/1972 Timmins
- D227,952 S 7/1973 Costabile et al.
- 3,881,471 A 5/1975 Grube
- D262,911 S 2/1982 Weddell
- D282,609 S 2/1986 Stulik
- D288,993 S 3/1987 Grimsrud
- 4,767,160 A 8/1988 Mengshoel et al.
- 4,994,648 A 2/1991 Gil
- D327,176 S 6/1992 Gil
- D339,012 S 9/1993 Sexton
- D346,043 S 4/1994 Galati, Jr. et al.
- D352,401 S 11/1994 Bonazza

(57) **CLAIM**

The ornamental design for a foot spa base, as shown and described.

DESCRIPTION

FIG. 1 is a perspective view of our foot spa base;
 FIG. 2 is a front plan view;
 FIG. 3 is a front elevation view;
 FIG. 4 is a back elevation view;
 FIG. 5 is a left side elevation view; and,
 FIG. 6 is a right side elevation view.

The broken line showing of a seat and bowl in FIGS. 1-6 is illustrative of environmental structure only and forms no part of the claimed design.

1 Claim, 4 Drawing Sheets

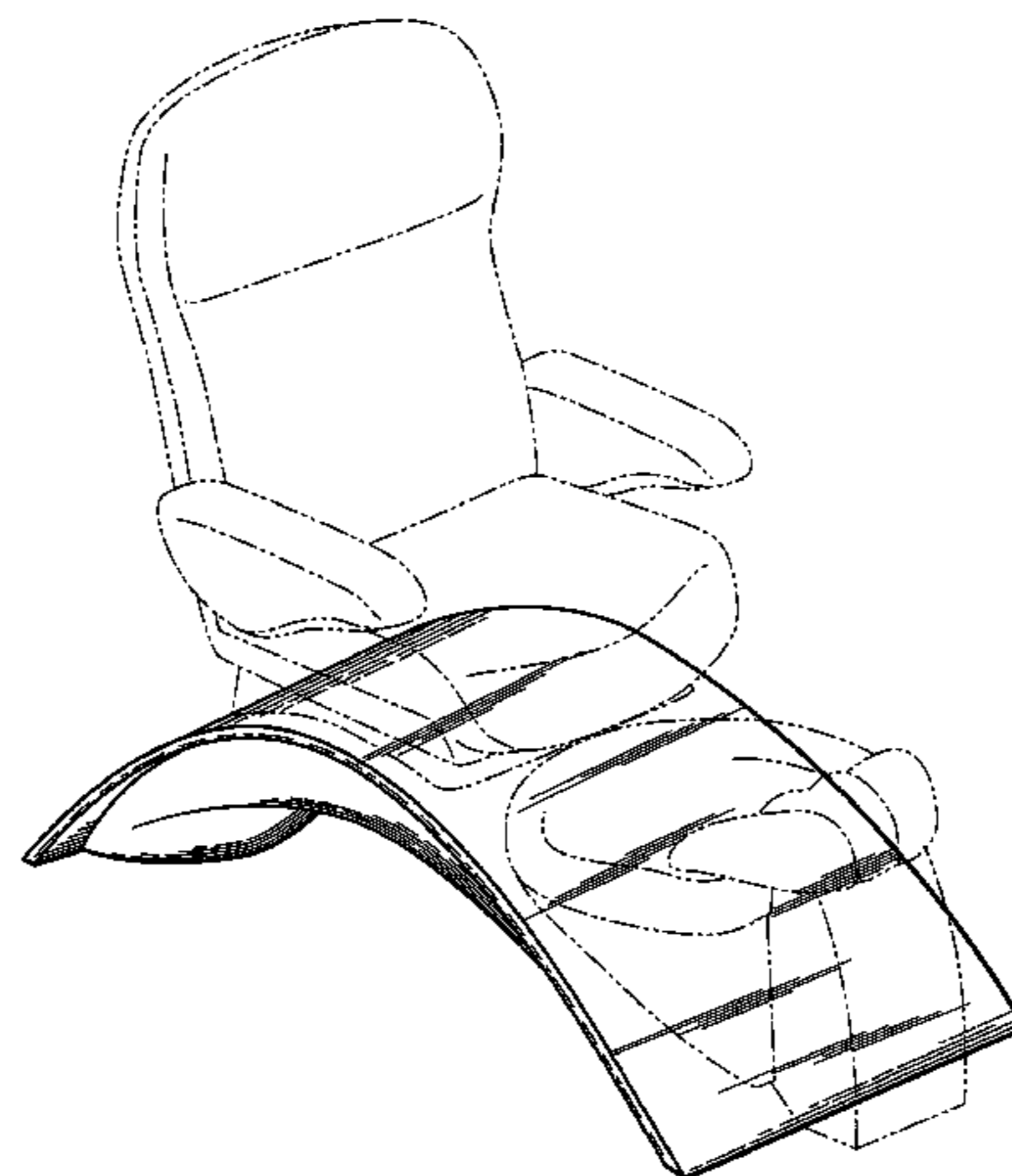

US D626,360 S

Page 2

U.S. PATENT DOCUMENTS

6,880,182 B2 4/2005 Gruenwald
D508,616 S 8/2005 Ziliani
D509,371 S 9/2005 Natuzzi
D526,505 S 8/2006 Gruenwald et al.
D531,420 S 11/2006 Kita
7,168,107 B2 1/2007 Gruenwald
D541,060 S 4/2007 Fugate et al.
7,228,579 B2 6/2007 Tidwell
D548,987 S 8/2007 McNae
D549,999 S 9/2007 Fugate et al.
D559,570 S 1/2008 Higgs et al.
7,322,949 B2 1/2008 Shimizu
D562,575 S 2/2008 Le
D568,485 S 5/2008 Ton
D569,135 S * 5/2008 Galati et al. D6/495
D569,986 S 5/2008 Ton
D571,018 S 6/2008 Ton et al.
D574,502 S 8/2008 Ton
D576,806 S 9/2008 Le
D576,807 S 9/2008 Le
D583,957 S 12/2008 Bromilow
D585,142 S * 1/2009 Galati et al. D24/213
7,490,374 B2 2/2009 Fugate et al.
D588,707 S 3/2009 Mai et al.
D589,285 S * 3/2009 Tran D6/495
D592,312 S 5/2009 Cheng
D596,417 S 7/2009 Bowen
7,669,934 B1 3/2010 Cline
D615,326 S * 5/2010 Tran D6/495
2004/0177438 A1 9/2004 Gruenwald et al.
2004/0244107 A1 12/2004 Waldron
2005/0183198 A1 8/2005 Gruenwald
2005/0204466 A1 9/2005 Luong
2007/0226896 A1 10/2007 Fugate et al.

2007/0226897 A1 10/2007 Fugate

OTHER PUBLICATIONS

Belvedere Company web pages, printed in 2007, 7 pages (<http://www.belvedere.com/home.aspx>).
European Touch web pages, printed in 2007, 8 pages (<http://europeantouch.com>).
Gulstream Plastics Ltd. web pages, printed in 2007, 7 pages (<http://www.gulstreamplastic.com>).
J&A USA web pages, printed in 2007, 10 pages (<http://www.jausainc.com>).
Lexus Footspas Inc. web pages, printed in 2007, 3 pages (<http://www.lexorinc.com>).
Salon Equipment, Inc. web pages, printed in 2007, 4 pages (<http://www.oasis-se.com/spas/>).
ProSpa Inc., web pages, printed in 2007, 2 pages (<http://www.prospa1.com/>).
Salon Tech, web pages, printed in 2007, 2 pages (<http://www.salontech.com/st2007/>).
Skyline Beauty Supply Corp.—Whale Spa, web pages, printed Mar. 20, 2008, 6 pages (<http://skylinebeautysupply.com>).
VNF International, web pages, printed Mar. 20, 2008, 6 pages (<http://www.pssnell-service.com/Manufacturer.htm>).
T4 Spa Concepts & Design, web pages, printed Mar. 20, 2008, 7 pages (<http://www.t4spa.com>).
Spa Zi, Division of LC Corp., web pages, printed Mar. 20, 2008, 4 pages (<http://www.thespazi.com>).
Sanijet—Pipeless Pedicure Equipment, web pages, printed Mar. 20, 2008, 2 pages (http://www.sanijet.com/Products_Pedicure.aspx).
Aqua Spas, web pages, printed Mar. 20, 2008, 3 pages (<http://aquaspa1.com>).
Beauty Mall Ltd., web pages, printed Mar. 20, 2008, 6 pages (<http://beautymallltd.com>).
Euro Spa, web page, printed Mar. 20, 2008, 1 page (<http://www.princesspedicurespas.com/manufacturer/eurospa.html#bella320>).

* cited by examiner

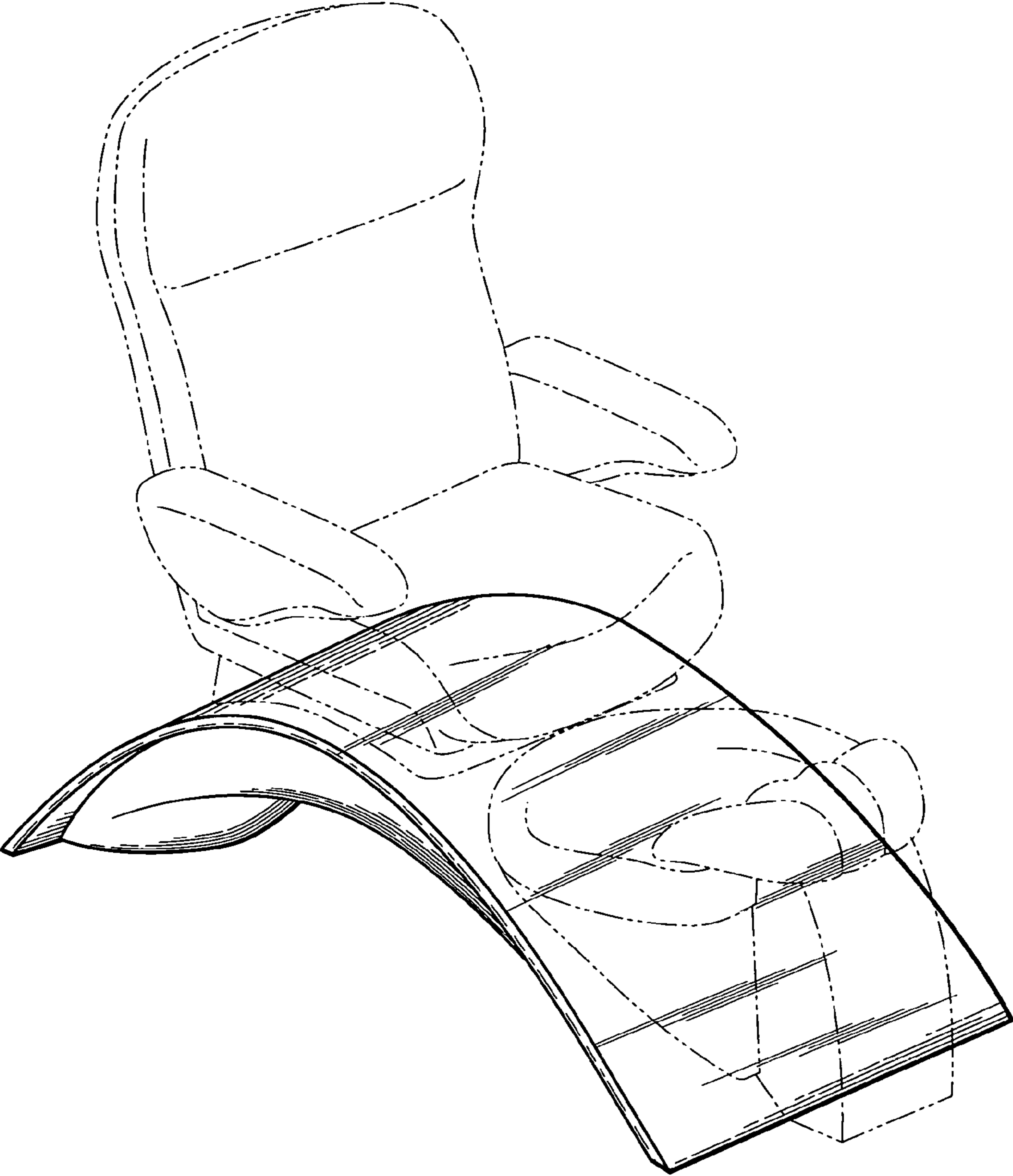

Fig. 1

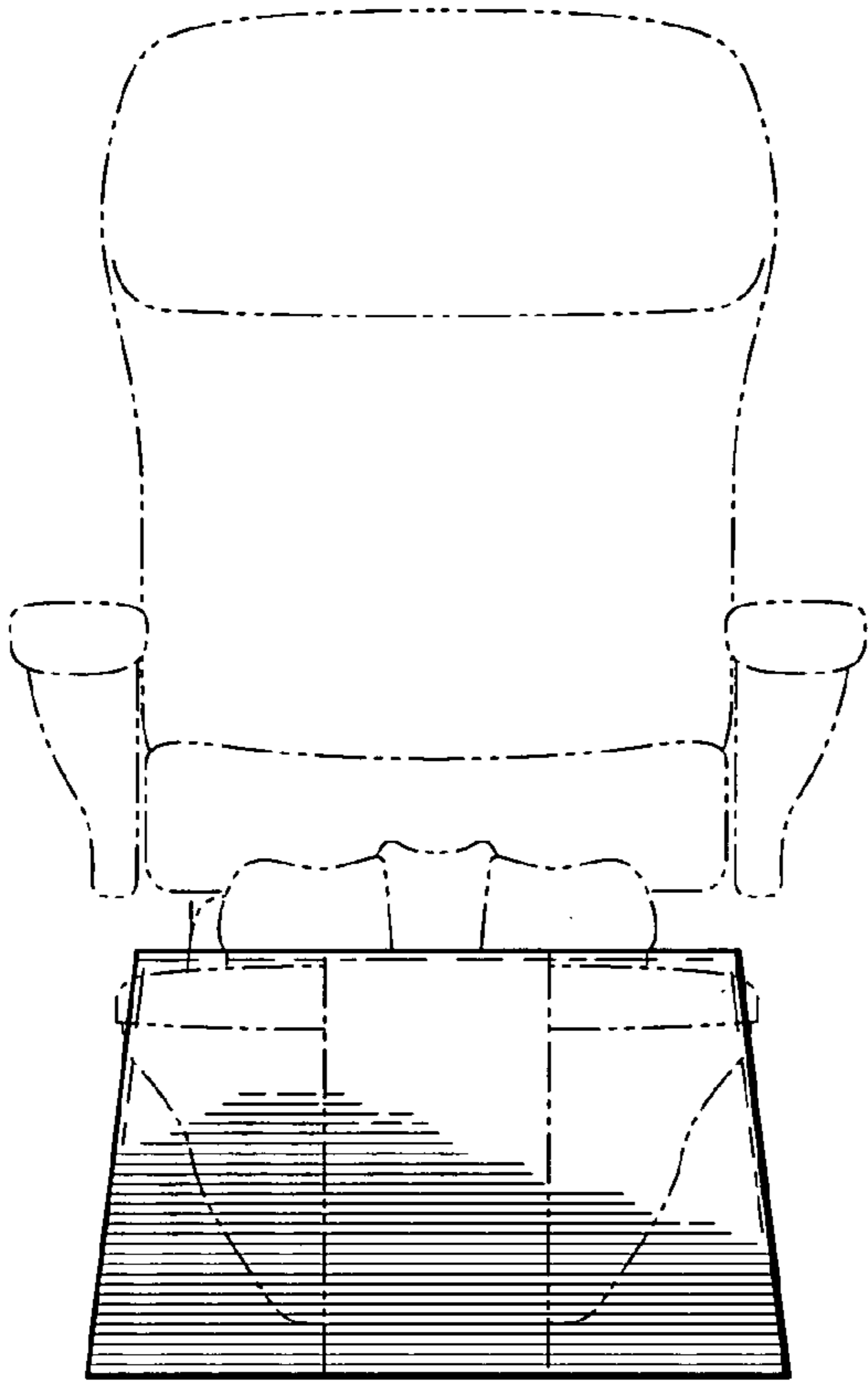

Fig. 2

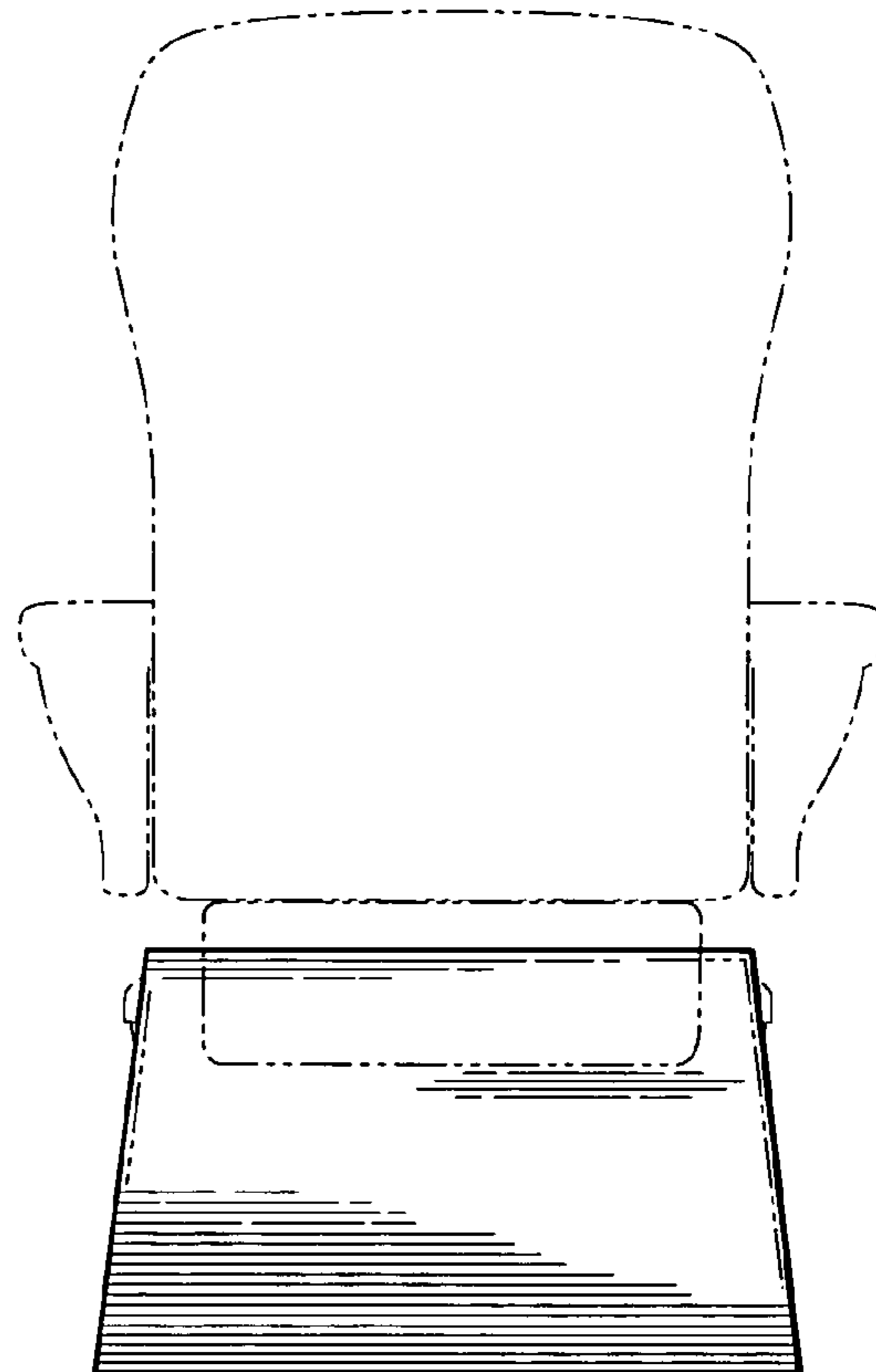

Fig. 3

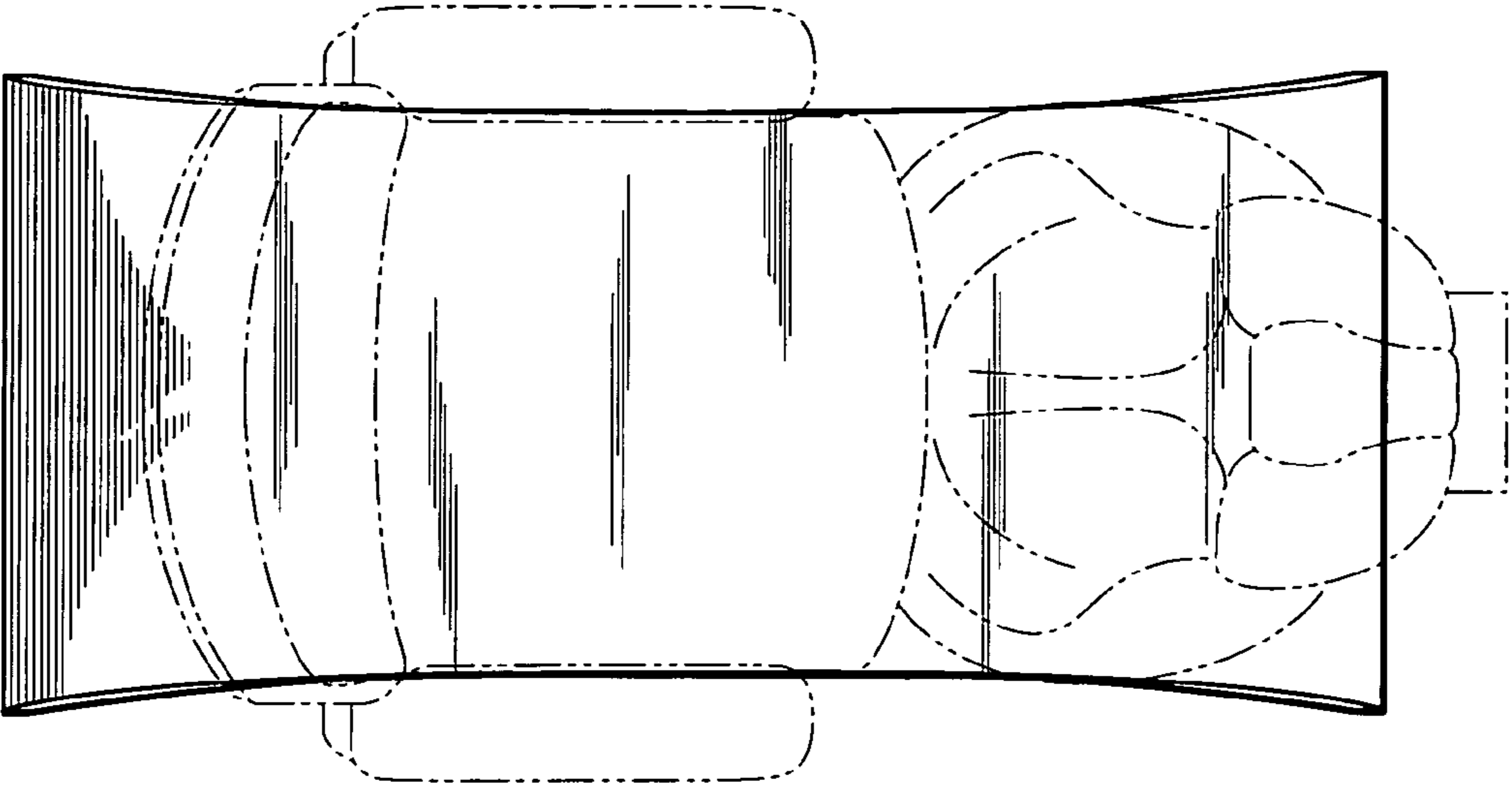

Fig. 4

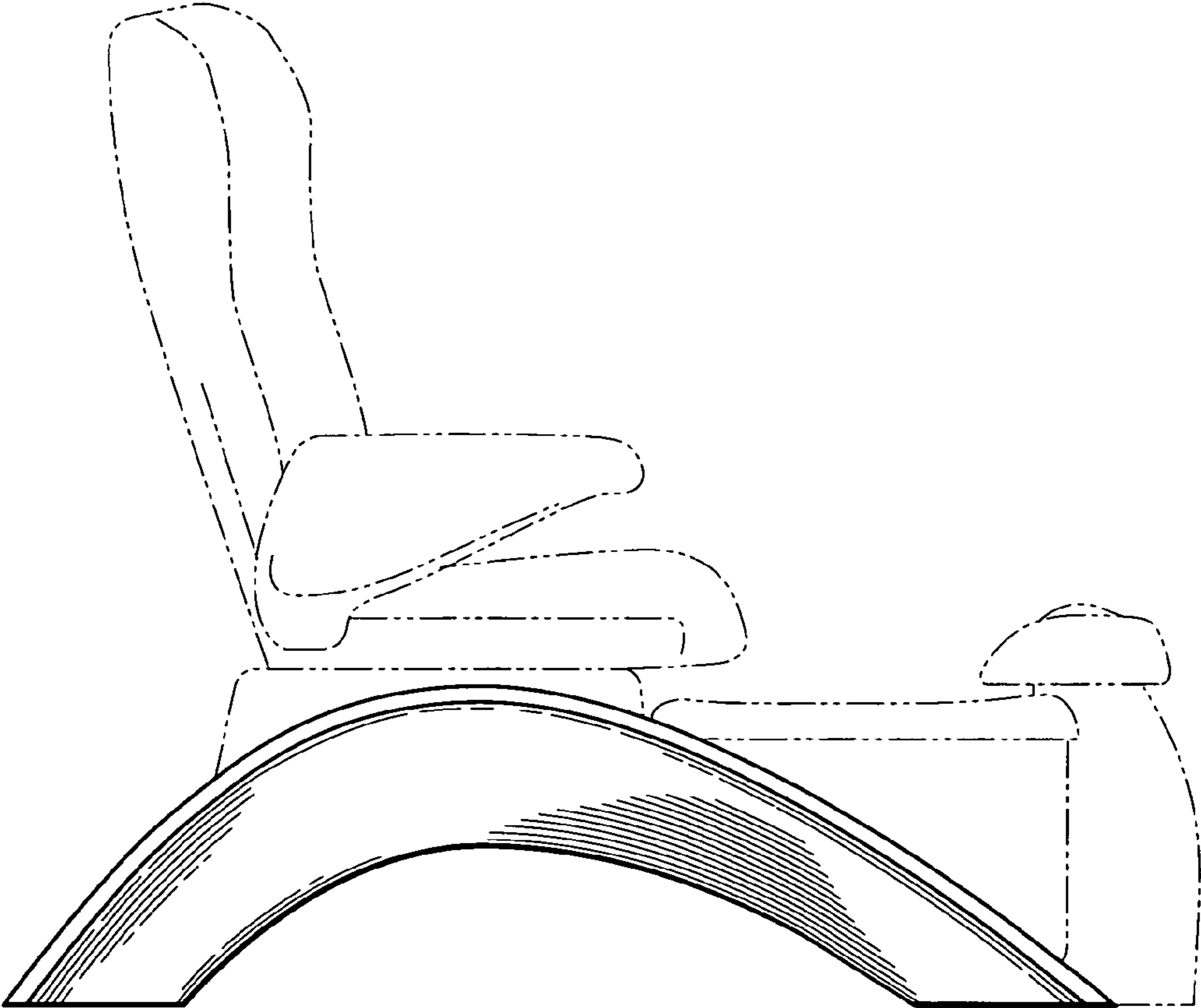

Fig. 5

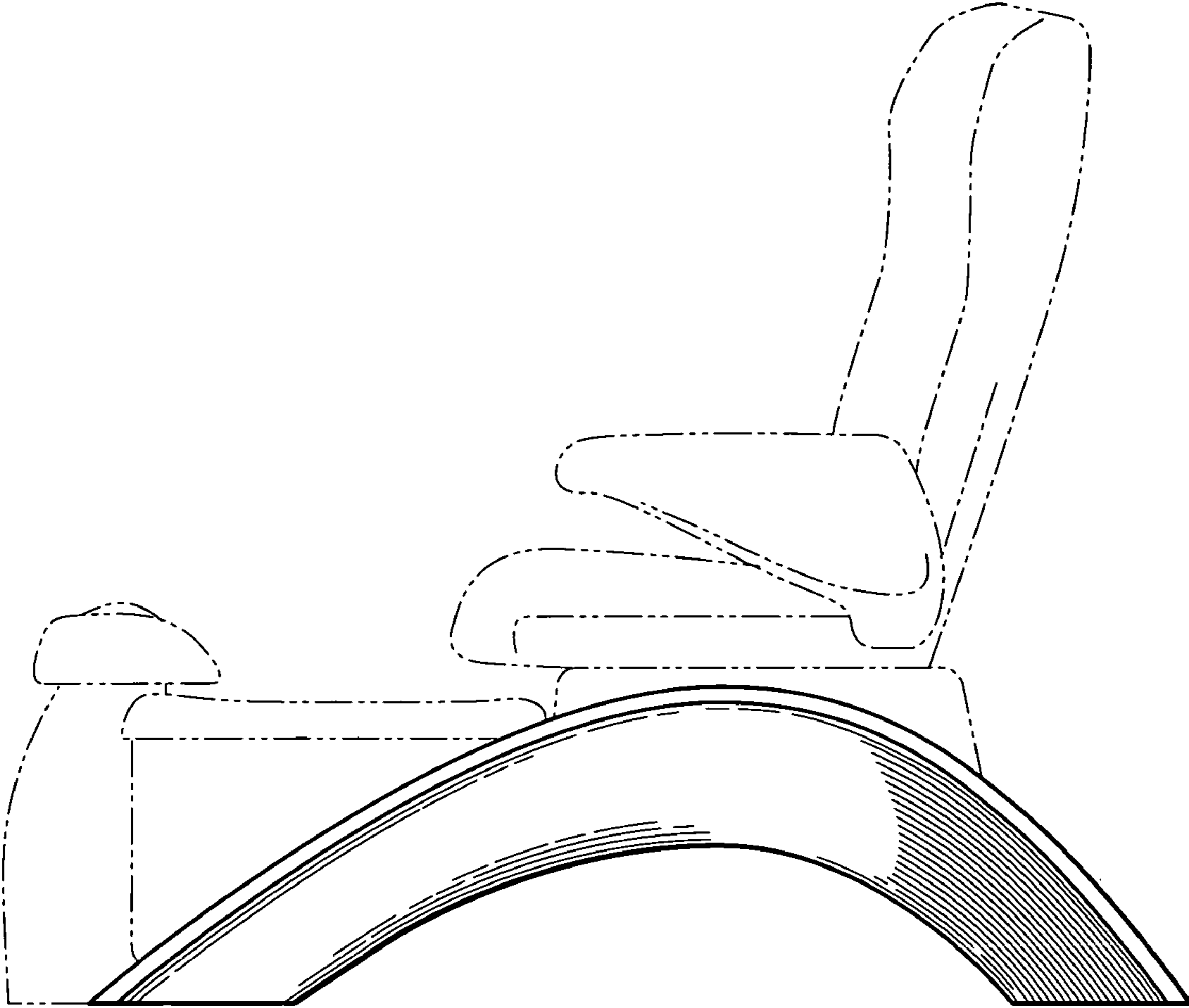

Fig. 6