



US00D626296S

(12) **United States Design Patent**  
**Porter**

(10) **Patent No.:** **US D626,296 S**

(45) **Date of Patent:** **\*\* \*Oct. 26, 2010**

(54) **PET GROOMING TOOL**

(75) Inventor: **David R. Porter**, Sunset Hills, MO (US)

(73) Assignee: **FURminator, Inc.**, Fenton, MO (US)

(\*\*) Term: **14 Years**

(21) Appl. No.: **29/350,299**

(22) Filed: **Nov. 13, 2009**

(51) **LOC (9) Cl.** ..... **30-99**

(52) **U.S. Cl.** ..... **D30/159**

(58) **Field of Classification Search** ..... D30/158-159,  
D30/199; 119/600, 601, 604-606, 611-619,  
119/625, 628-633; D4/132-138, 100-102,  
D4/122, 127, 119, 114, 199; D8/106, 107,  
D8/13, 45, 14, DIG. 4, DIG. 7, DIG. 8; 401/28;  
132/119-121, 152, 154, 147-150, 108-110,  
132/112-115; D28/31, 63, 30, 25, 44, 44.1,  
D28/45-48; 15/50.1-50.3, 55, 57, 71, 77,  
15/79.1, 104.002, 105-106, 143.1, 159.1,  
15/160, 186-188, 169, 236.01, 236.02, 245,  
15/117, 121, 245.1; 56/400.01, 400.17, 400.21;  
81/177.7, 489, 177.1, 436-440; 16/426,  
16/421, 422, 110.1, 430, DIG. 12, DIG. 19,  
16/431; 30/353, 32, 34.05, 47, 49, 526, 527,  
30/169, 171; D24/147, 133; D7/688, 393,  
D7/395, 401.2; 606/161; D32/40, 41, 49,  
D32/46, 51

See application file for complete search history.

(56) **References Cited**

**U.S. PATENT DOCUMENTS**

487,580 A \* 12/1892 Neuls ..... 119/631  
D142,930 S \* 11/1945 Adler ..... D28/31  
3,170,182 A \* 2/1965 Burian ..... 15/142  
6,213,055 B1 \* 4/2001 Willinger et al. .... 119/633  
6,279,582 B1 \* 8/2001 Wang ..... 132/154  
6,450,127 B2 \* 9/2002 Willinger et al. .... 119/633  
6,543,388 B2 \* 4/2003 Willinger et al. .... 119/633  
6,668,758 B1 \* 12/2003 Davis, Jr. .... 119/608  
6,782,846 B1 8/2004 Porter

6,955,137 B2 \* 10/2005 Dunn et al. .... 119/625  
D525,744 S \* 7/2006 Dibnah et al. .... D28/44  
7,077,076 B2 7/2006 Porter  
7,222,588 B2 5/2007 Porter  
7,334,540 B2 2/2008 Porter  
D565,258 S 3/2008 Porter  
7,509,926 B2 3/2009 Porter  
7,650,857 B2 1/2010 Porter  
7,650,858 B2 1/2010 Porter  
2001/0011528 A1 \* 8/2001 Willinger et al. .... 119/633  
2002/0040686 A1 \* 4/2002 Willinger et al. .... 119/633  
2004/0194728 A1 \* 10/2004 Dunn et al. .... 119/625  
2007/0084416 A1 \* 4/2007 Liao ..... 119/625

(Continued)

**OTHER PUBLICATIONS**

Pet Solutions Catalogue, Sep. 2009, p. 31 (1 page).\*

(Continued)

*Primary Examiner*—Susan Moon Lee

(74) *Attorney, Agent, or Firm*—Thompson Coburn LLP;  
Clyde L. Smith

(57)

**CLAIM**

I claim the ornamental design for a pet grooming tool, as shown and described.

**DESCRIPTION**

FIG. 1 is a bottom view of the pet grooming tool showing my new design.

FIG. 2 is a top view of thereof.

FIG. 3 is a front view thereof.

FIG. 4 is a rear view thereof.

FIG. 5 is a right side view thereof, the left side view being a mirror image of the right side view; and,

FIG. 6 is a perspective view thereof.

**1 Claim, 5 Drawing Sheets**

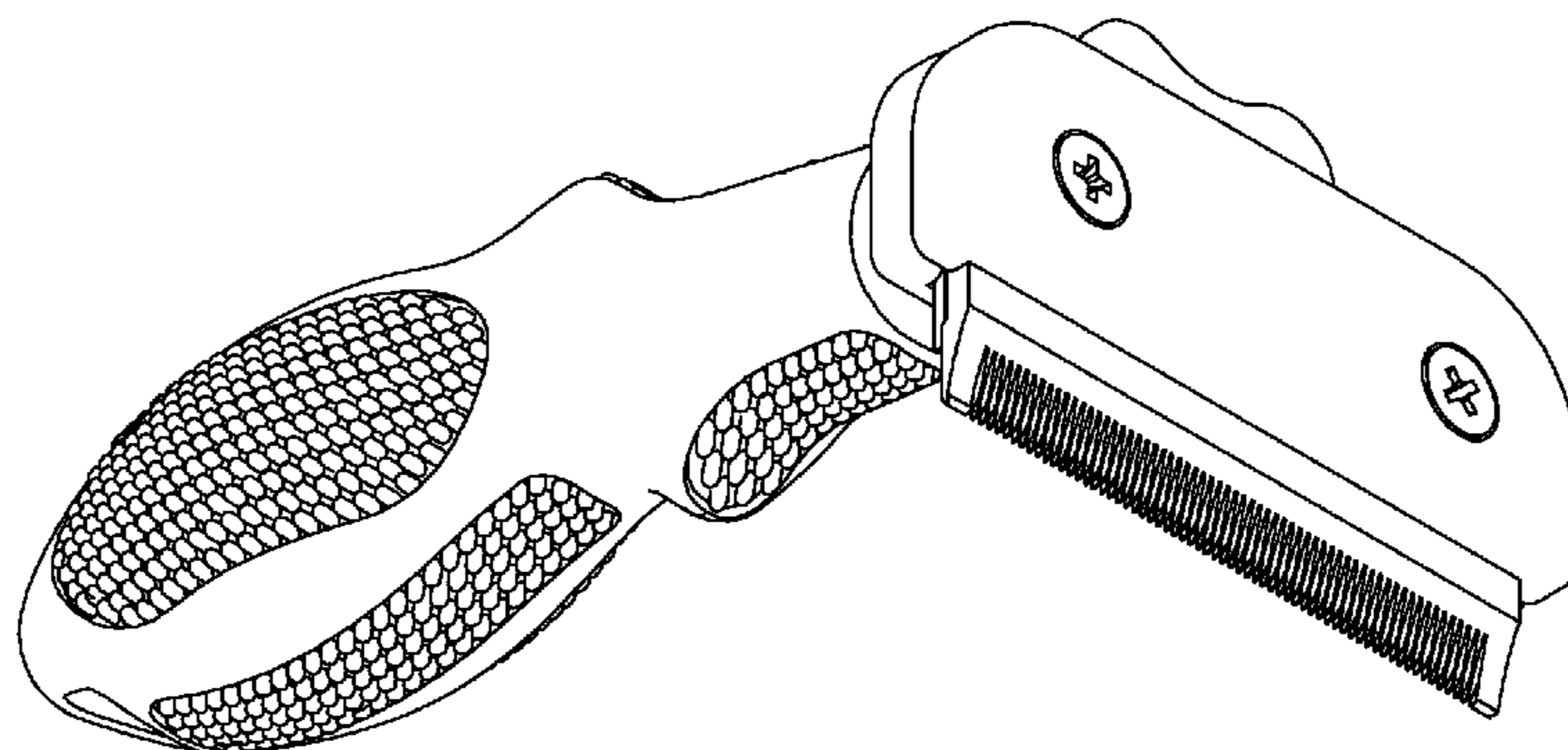

# US D626,296 S

Page 2

---

## U.S. PATENT DOCUMENTS

2008/0029044 A1 2/2008 Porter  
2008/0066690 A1\* 3/2008 Rosen ..... 119/612  
2008/0078333 A1\* 4/2008 Wang ..... 119/611  
2009/0126648 A1 5/2009 Porter  
2009/0126649 A1 5/2009 Porter

## OTHER PUBLICATIONS

JB Wholesale catalogue, Nov. 2006, pp. 80 -81 (2 pages).\*  
Care-al-Lot catalogue, Oct. 2003, p. 62 (1 page).\*

1. Jeffers Pet Catalogue, Jun. 2005, p. 85 (1 page) 2. Jeffers Pet Catalogue, Jul. 2007, pp. 92-93 (2 pages).\*

1. Drs Foster and Smith Pet catalogue, Jul. 2005, p. 102 (1 page) 2. Drs Foster and Smith Pet catalogue, 2002 Issue, p. 105 (1 page).\*

UPCO Pet Catalogue, Fall 2005, pp. 35-36 (2 pages).\*

Applicant's prior art product offered for sale to the public in the United States on and before Nov. 12, 2008, 7 pages.

\* cited by examiner

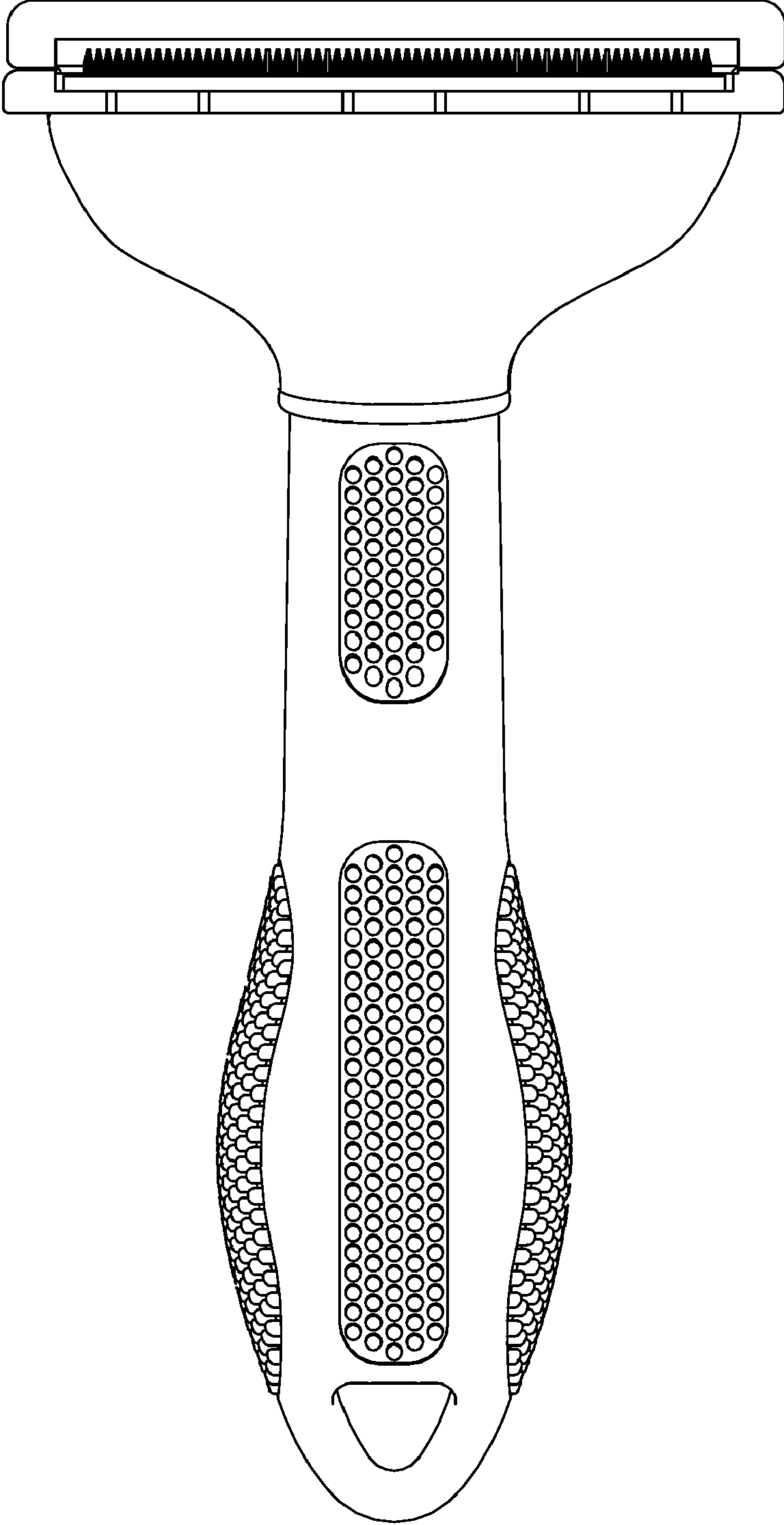

FIG. 1

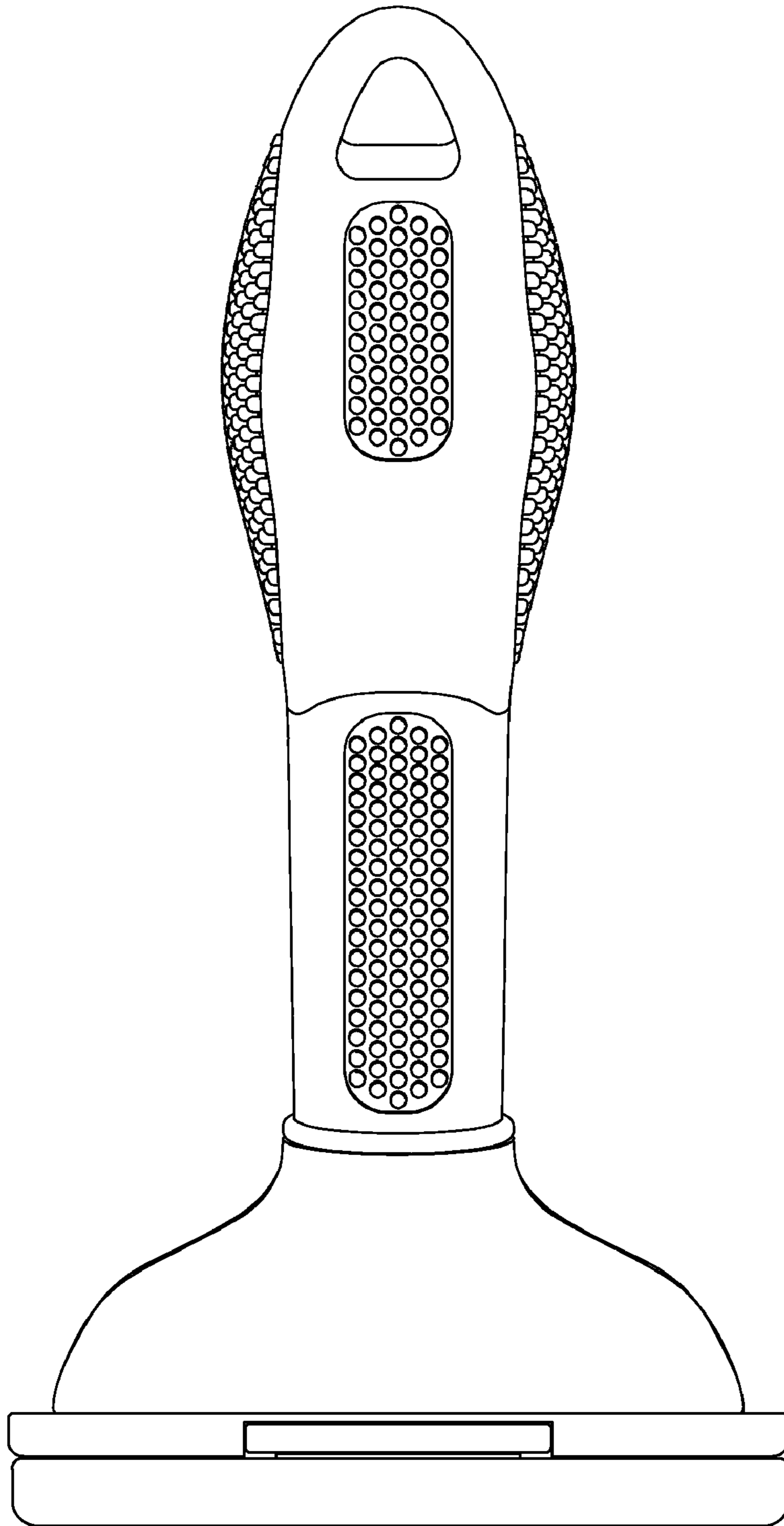

Fig. 2

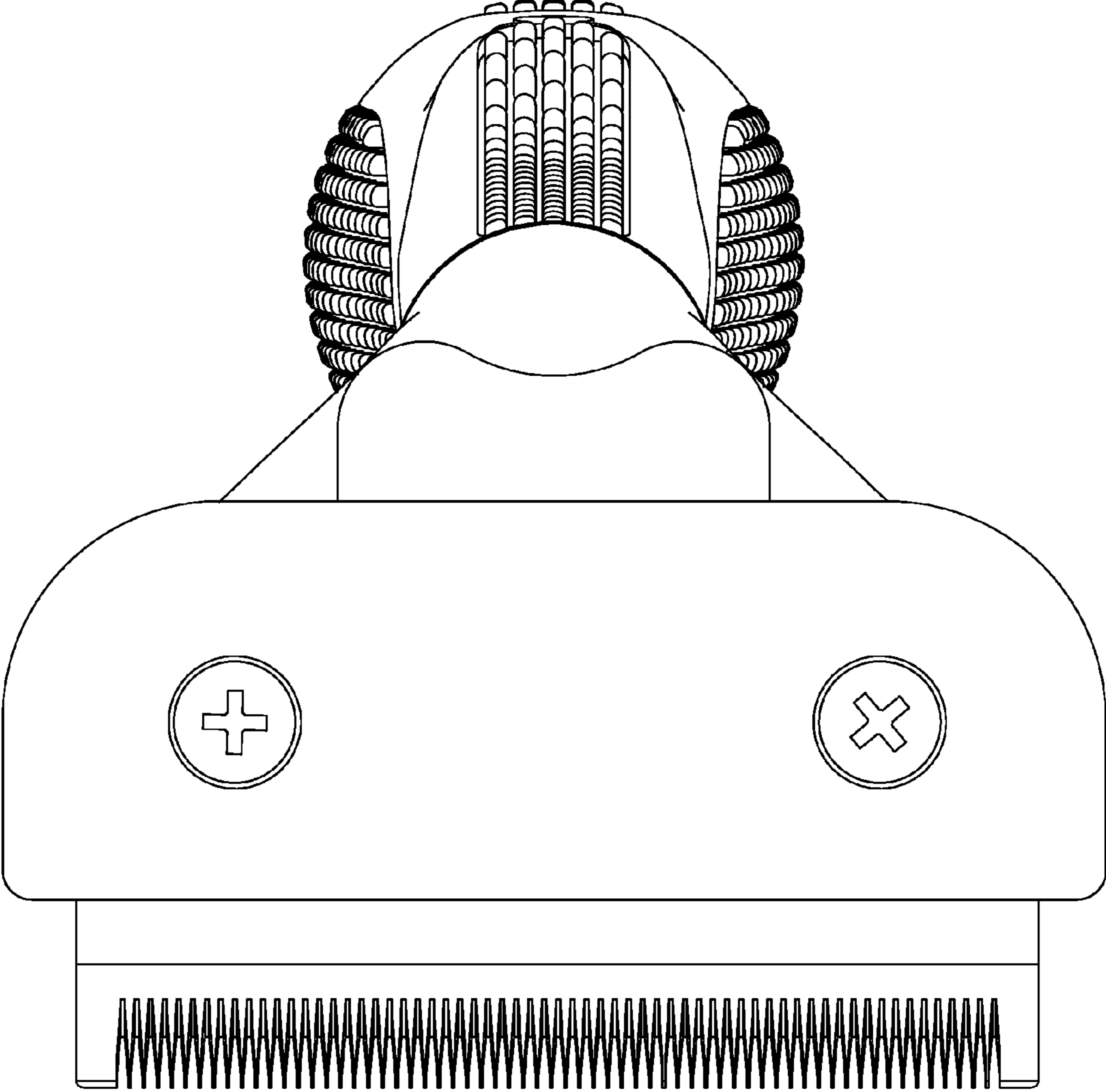

FIG. 3

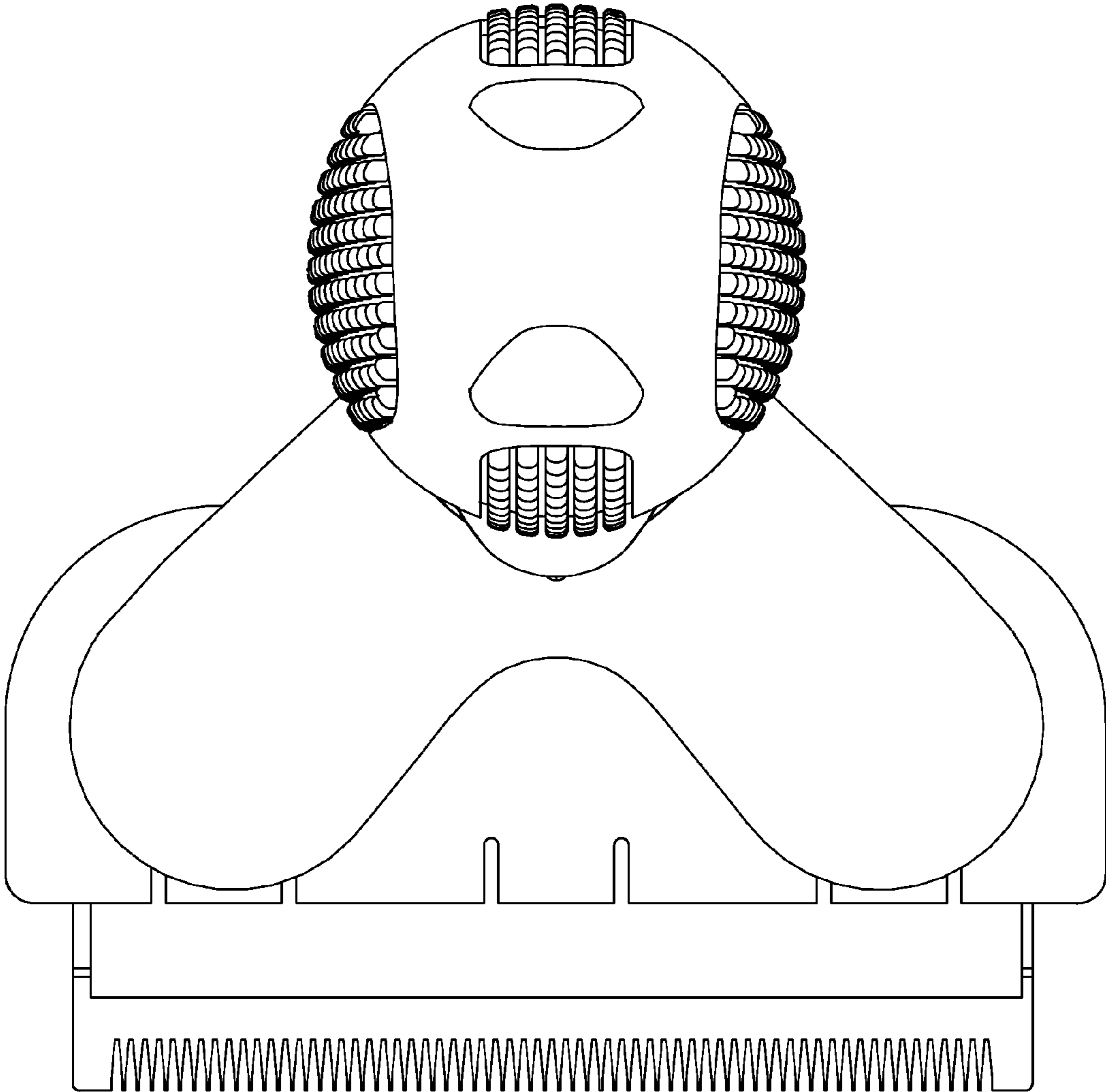

FIG. 4

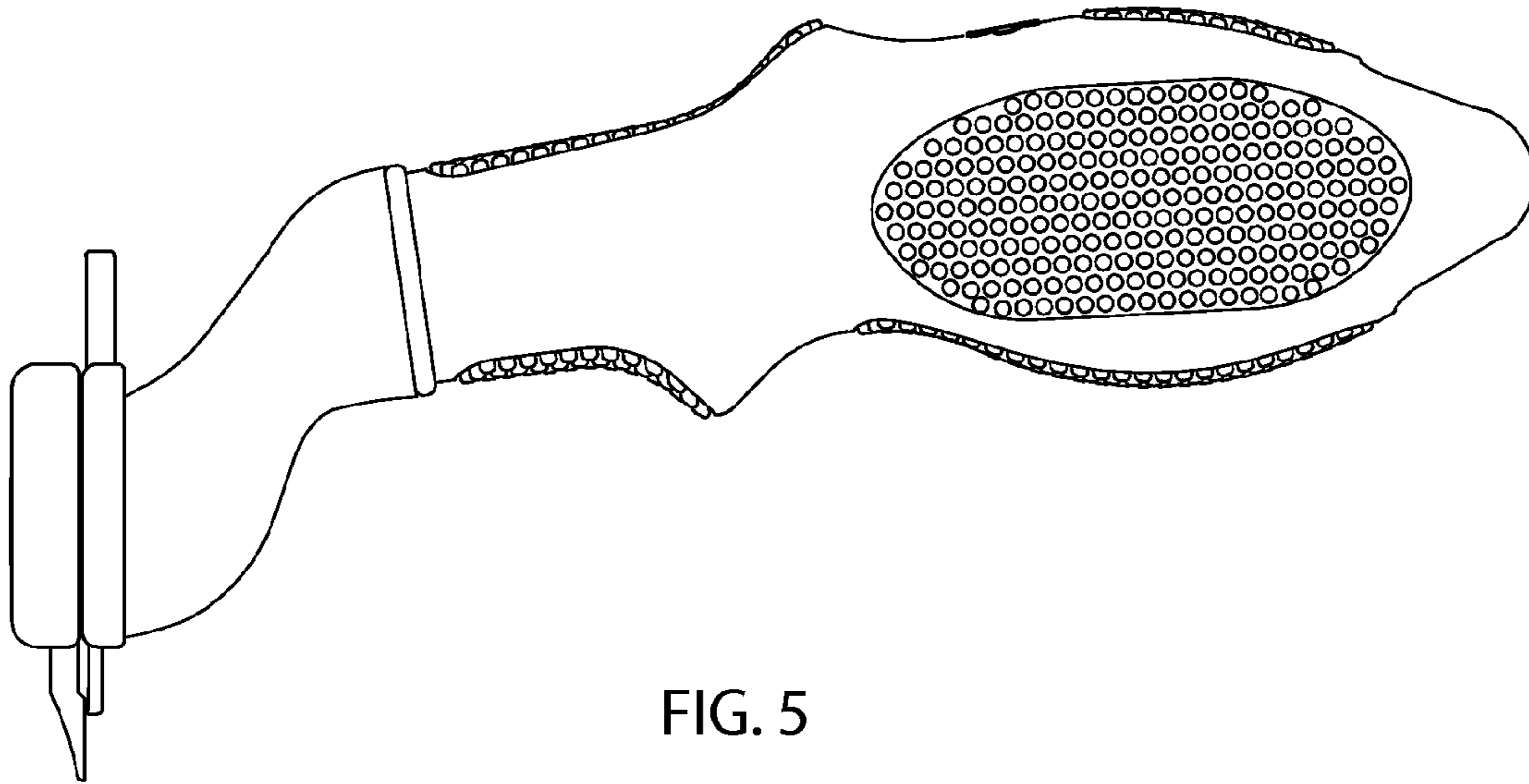

FIG. 5

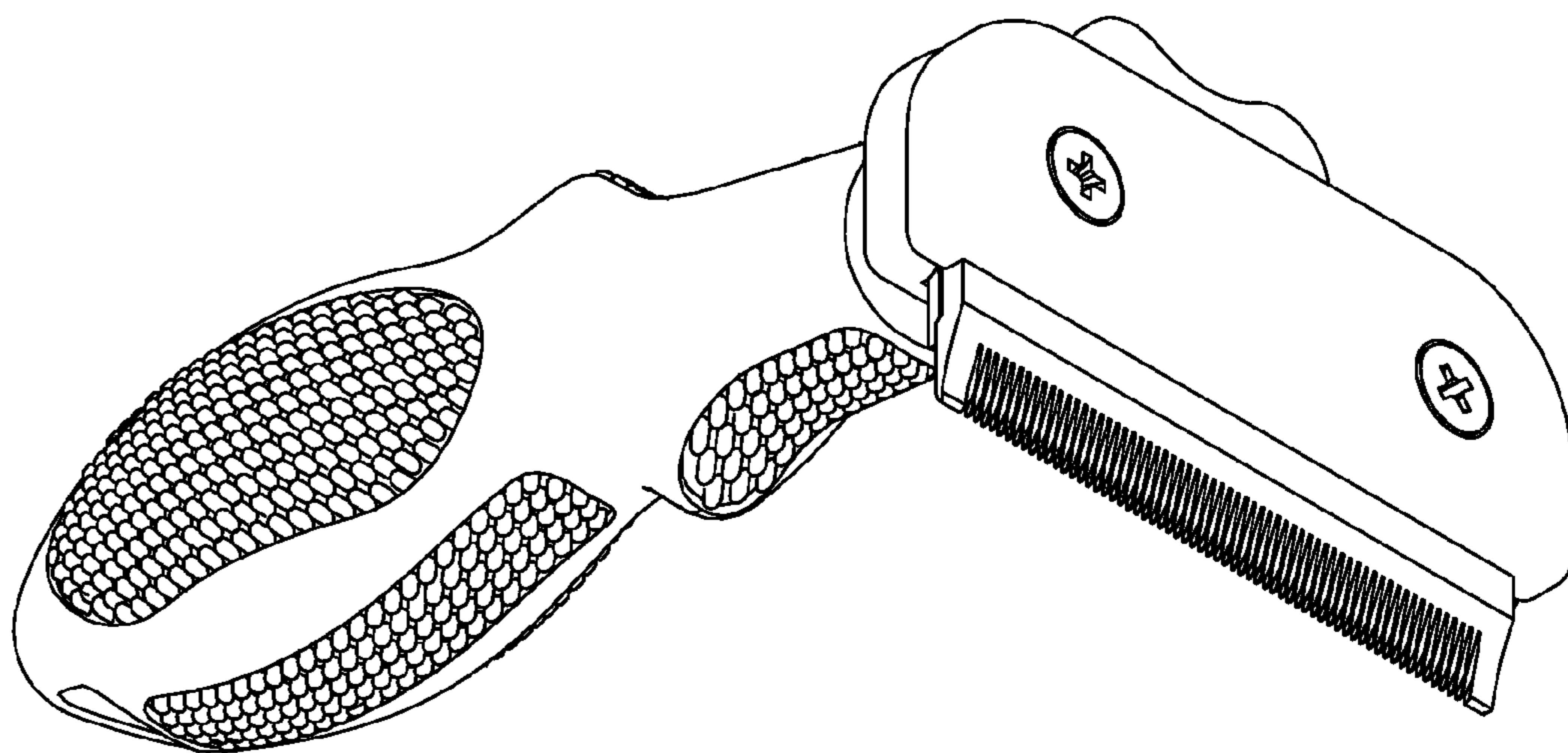

FIG. 6