



US00D626283S

(12) **United States Design Patent**
Renner

(10) **Patent No.:** **US D626,283 S**
(45) **Date of Patent:** **** Oct. 26, 2010**

(54) **ACCESSORY FOR A LAMP**

(75) Inventor: **Markus Renner, Völs (AT)**

(73) Assignee: **Swarovski Aktiengesellschaft, Triesen (LI)**

(**) Term: **14 Years**

(21) Appl. No.: **29/365,653**

(22) Filed: **Jul. 13, 2010**

(30) **Foreign Application Priority Data**

May 26, 2010 (EM) 001712175-0001

(51) **LOC (9) Cl.** **26-99**

(52) **U.S. Cl.** **D26/154**

(58) **Field of Classification Search** D26/2,
D26/118, 120, 129, 138, 63, 65, 128, 154,
D26/119, 28, 155, 142, 121, 122, 152, 123,
D26/124, 153, 130, 141, 92, 87, 93, 85, 145;
D11/89, 90, 91, 92; 273/153 S, 160; 362/223,
362/544, 240, 545; D9/529; D21/478, 479;
D34/1; D7/509, 586; D13/134, 179, 180
See application file for complete search history.

(56) **References Cited**

U.S. PATENT DOCUMENTS

D45,668 S * 4/1914 Heller D11/90

D400,819 S * 11/1998 Ambar D11/90
D419,909 S * 2/2000 Freilich D11/90
D434,692 S * 12/2000 Freilich D11/90
D526,925 S * 8/2006 Granig D11/90
D560,540 S * 1/2008 Tabertshofer D11/90
D593,896 S * 6/2009 Schneider D11/89
D593,897 S * 6/2009 Schneider D11/89
D603,747 S * 11/2009 Meyer D11/89

* cited by examiner

Primary Examiner—Cathron C Brooks

Assistant Examiner—Kevin K Rudzinski

(74) *Attorney, Agent, or Firm*—Wenderoth, Lind & Ponack, L.L.P.

(57) **CLAIM**

The ornamental design for an accessory for a lamp, as shown and described.

DESCRIPTION

FIG. 1 is a bottom view of the invention;
FIG. 2 is a right view of the invention;
FIG. 3 is a front view of the invention;
FIG. 4 is a left view of the invention;
FIG. 5 is a rear view of the invention;
FIG. 6 is a top view of the invention; and,
FIG. 7 is a perspective view of the invention.

1 Claim, 2 Drawing Sheets

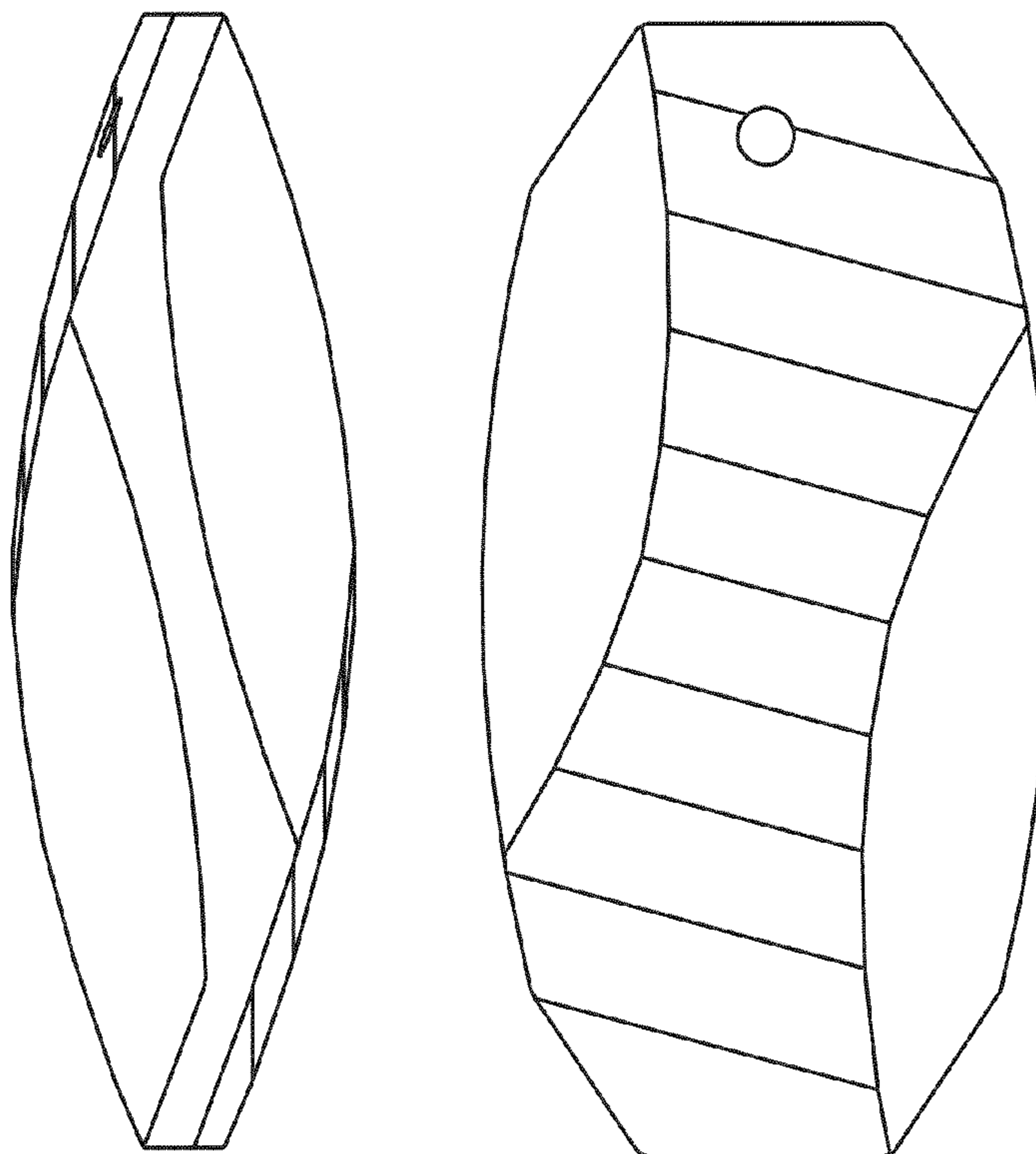

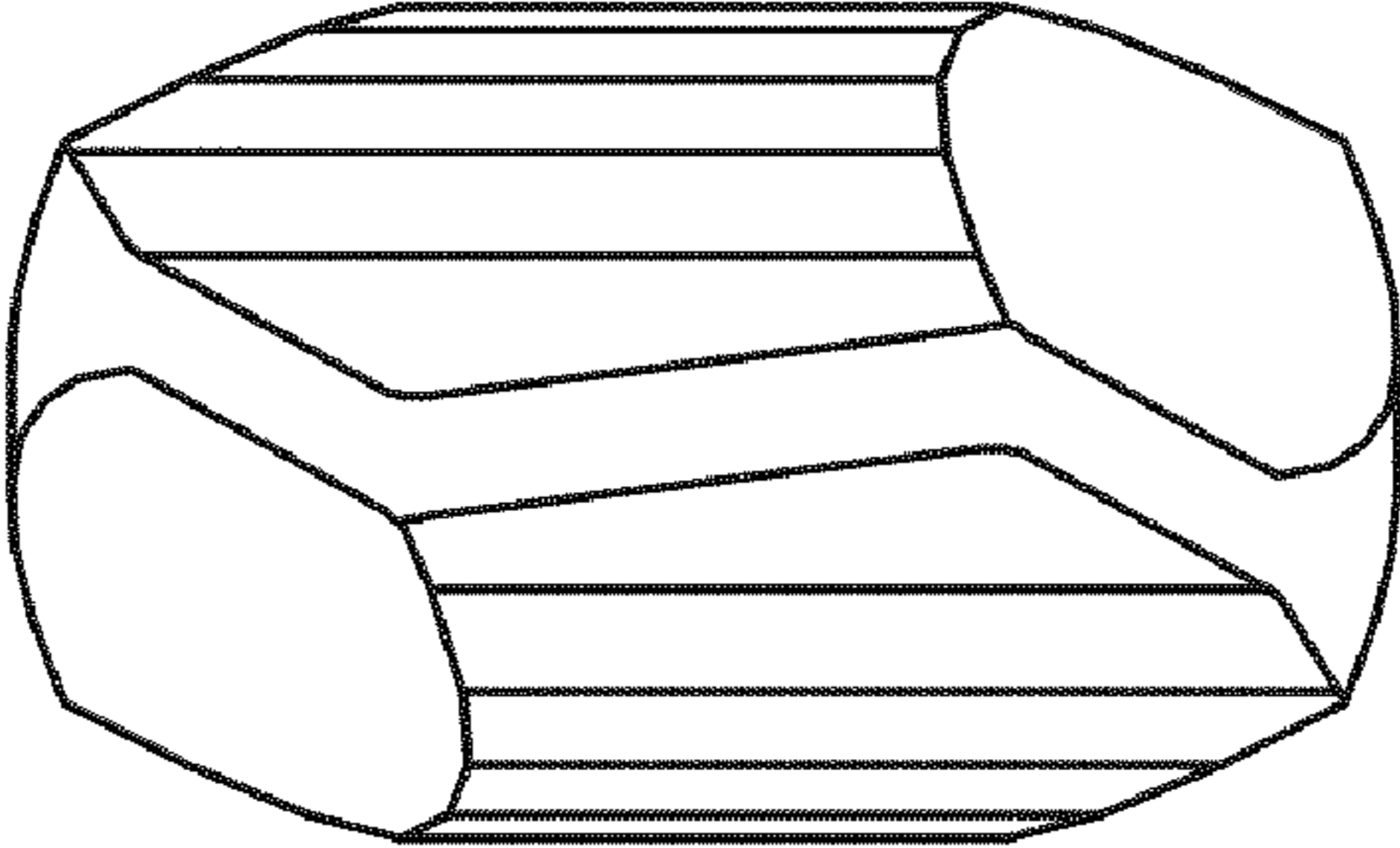

Fig. 1

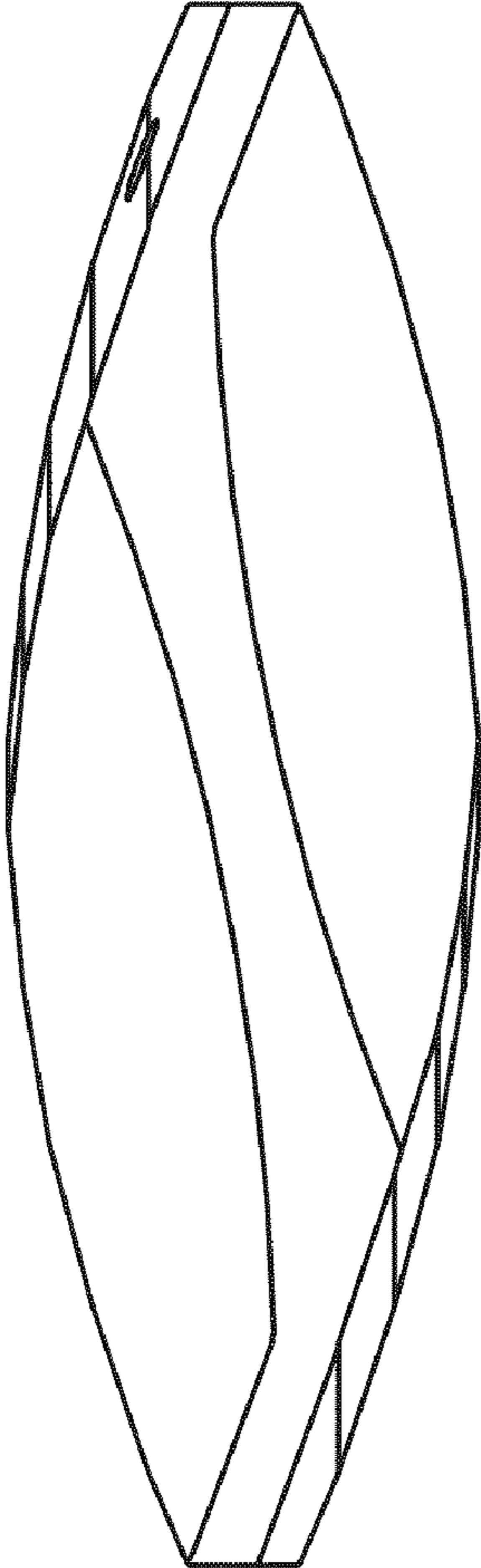

Fig. 2

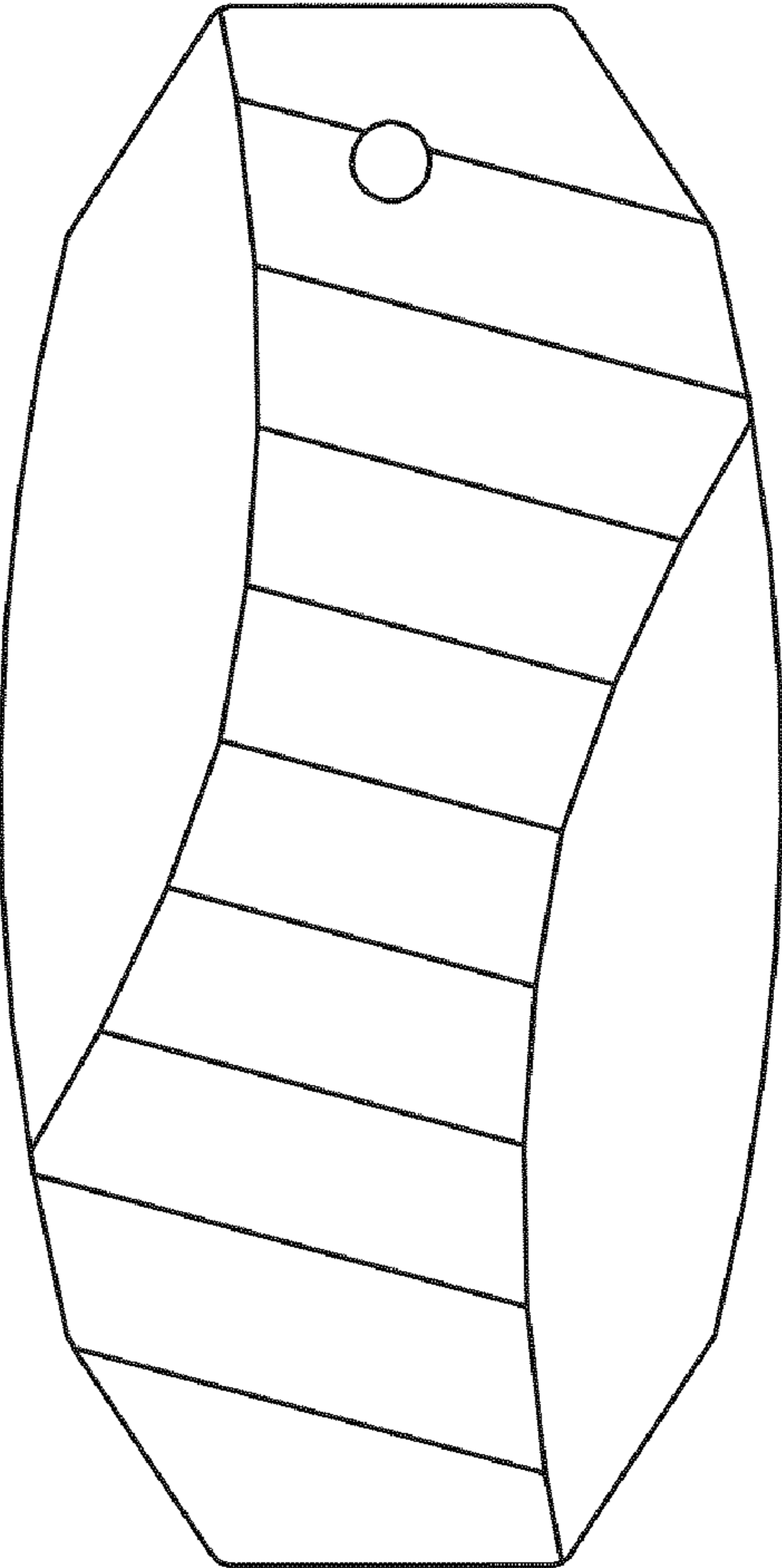

Fig. 3

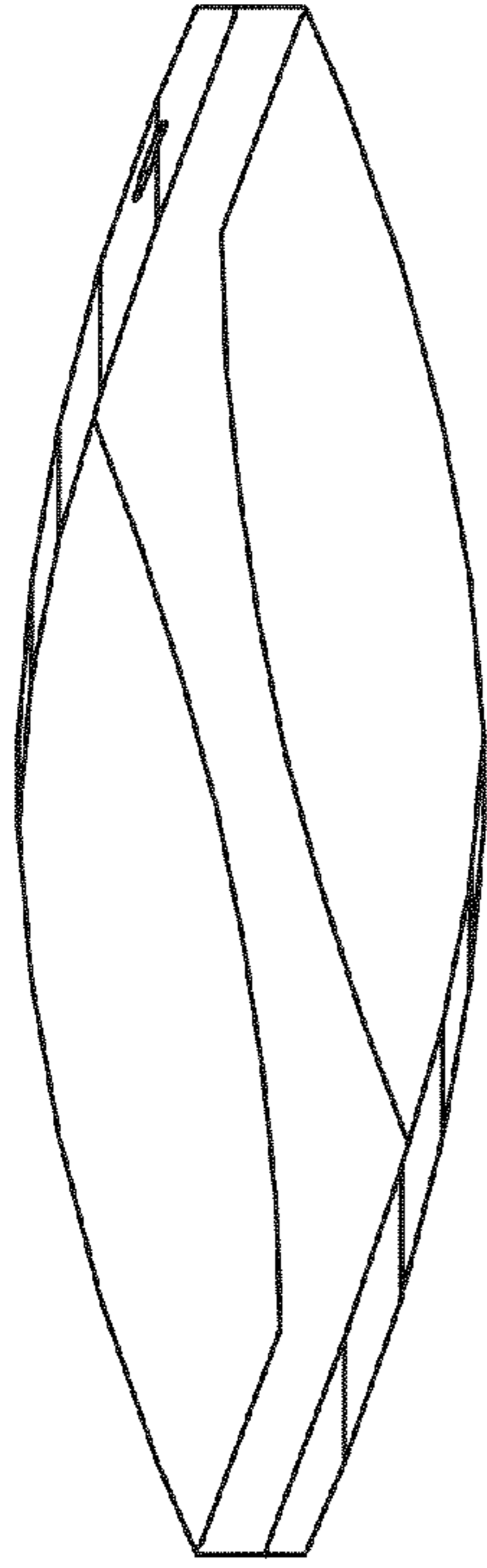

Fig. 4

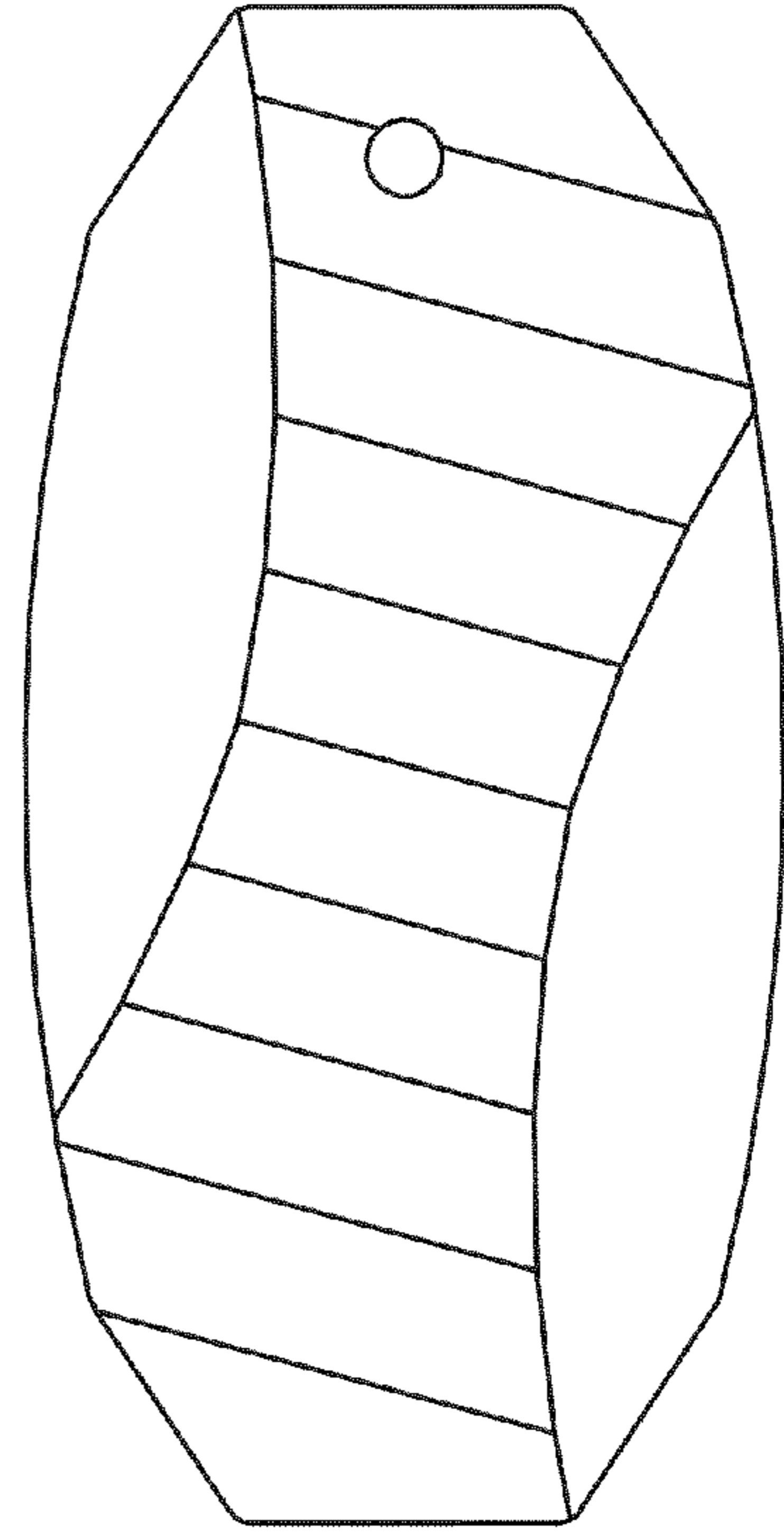

Fig. 5

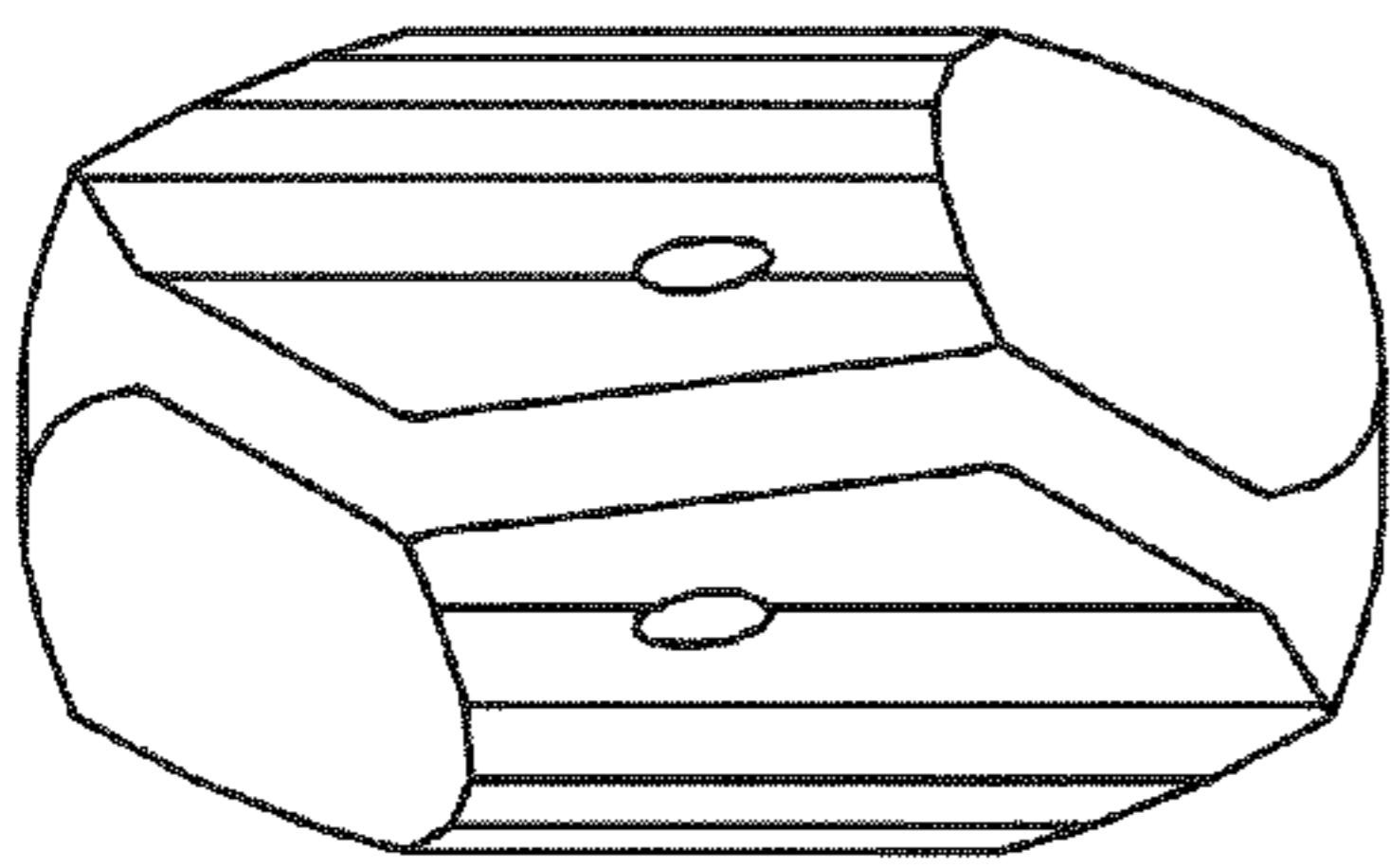

Fig. 6

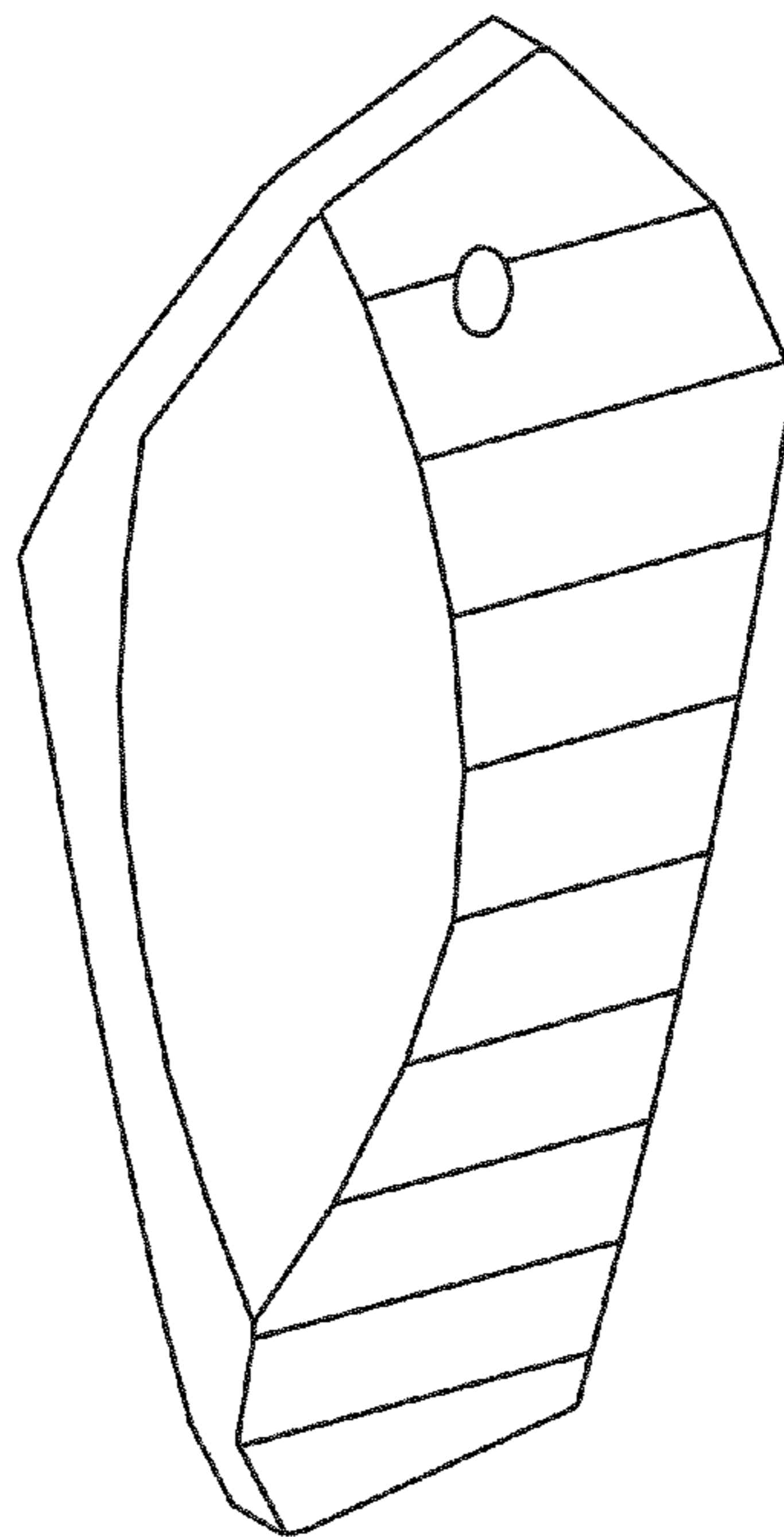

Fig. 7