



US00D626263S

(12) **United States Design Patent**
Shurtleff

(10) **Patent No.:** **US D626,263 S**

(45) **Date of Patent:** **** Oct. 26, 2010**

(54) **CEILING FAN LIGHT KIT**

D505,722 S * 5/2005 Burns D23/411

(75) Inventor: **Mark L. Shurtleff**, Long Beach, CA
(US)

* cited by examiner

Primary Examiner—Lisa P Lichtenstein

(73) Assignee: **Landmark Enterprise Inc.**, Bandar Seri
Begawan (BN)

(74) *Attorney, Agent, or Firm*—Ming Chow; Sinorica, LLC

(**) Term: **14 Years**

(57) **CLAIM**

(21) Appl. No.: **29/358,323**

I claim the ornamental design for a ceiling fan light kit, as shown and described.

(22) Filed: **Mar. 25, 2010**

DESCRIPTION

(51) **LOC (9) Cl.** **26-05**

FIG. 1 is a front perspective view of a ceiling fan light kit showing my new design;

(52) **U.S. Cl.** **D26/59**

FIG. 2 is a front elevational view thereof;

(58) **Field of Classification Search** D23/411,
D23/377, 379, 385; D26/59, 51, 72, 81–86,
D26/88; 416/5; 362/96

FIG. 3 is a rear elevational view thereof.

See application file for complete search history.

FIG. 4 is a left side elevational view thereof;

FIG. 5 is a right side elevational view thereof;

(56) **References Cited**

FIG. 6 is a top plan view thereof; and,

FIG. 7 is a bottom plan view thereof.

U.S. PATENT DOCUMENTS

D478,183 S * 8/2003 Burns D26/59

1 Claim, 4 Drawing Sheets

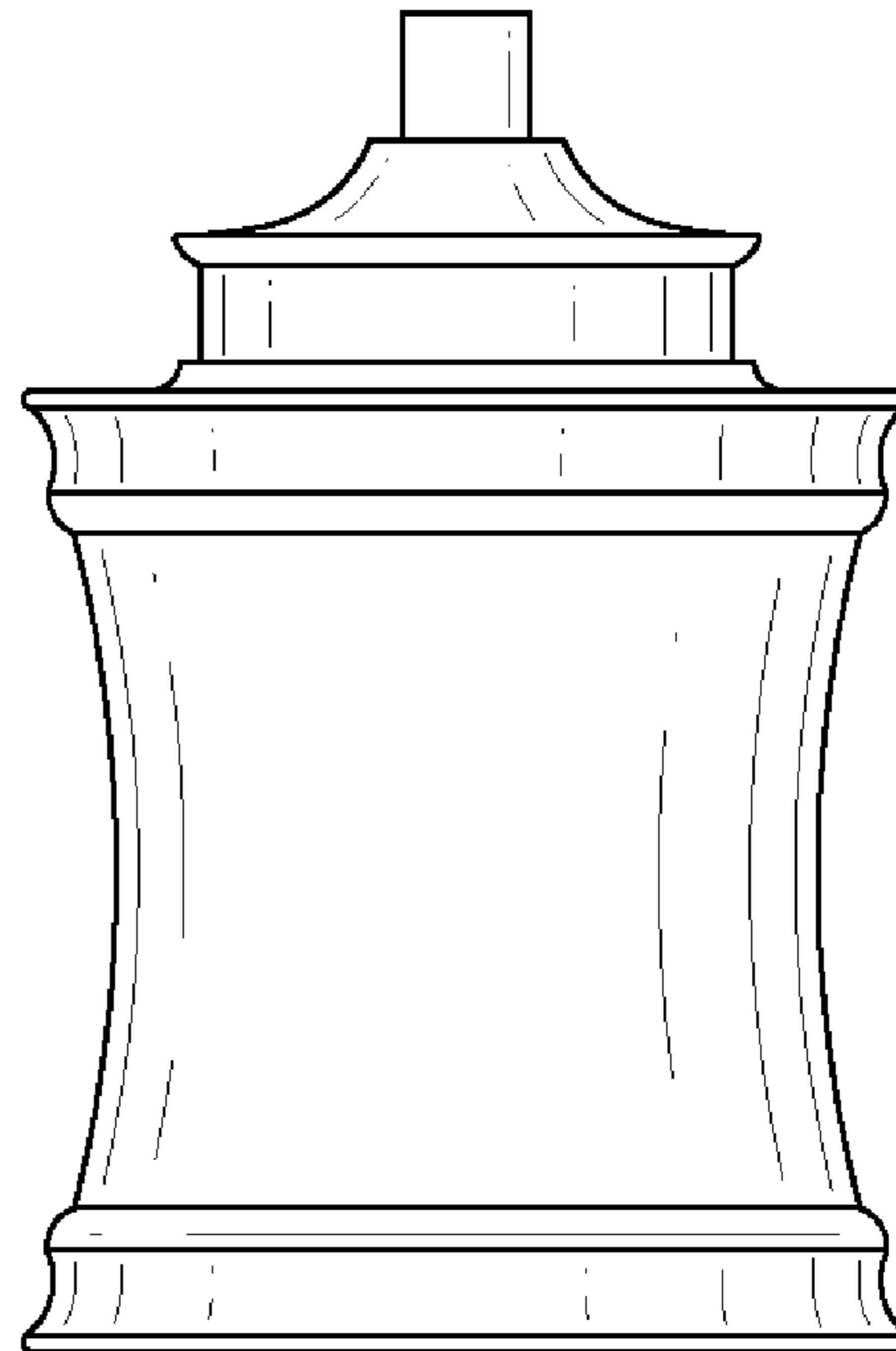
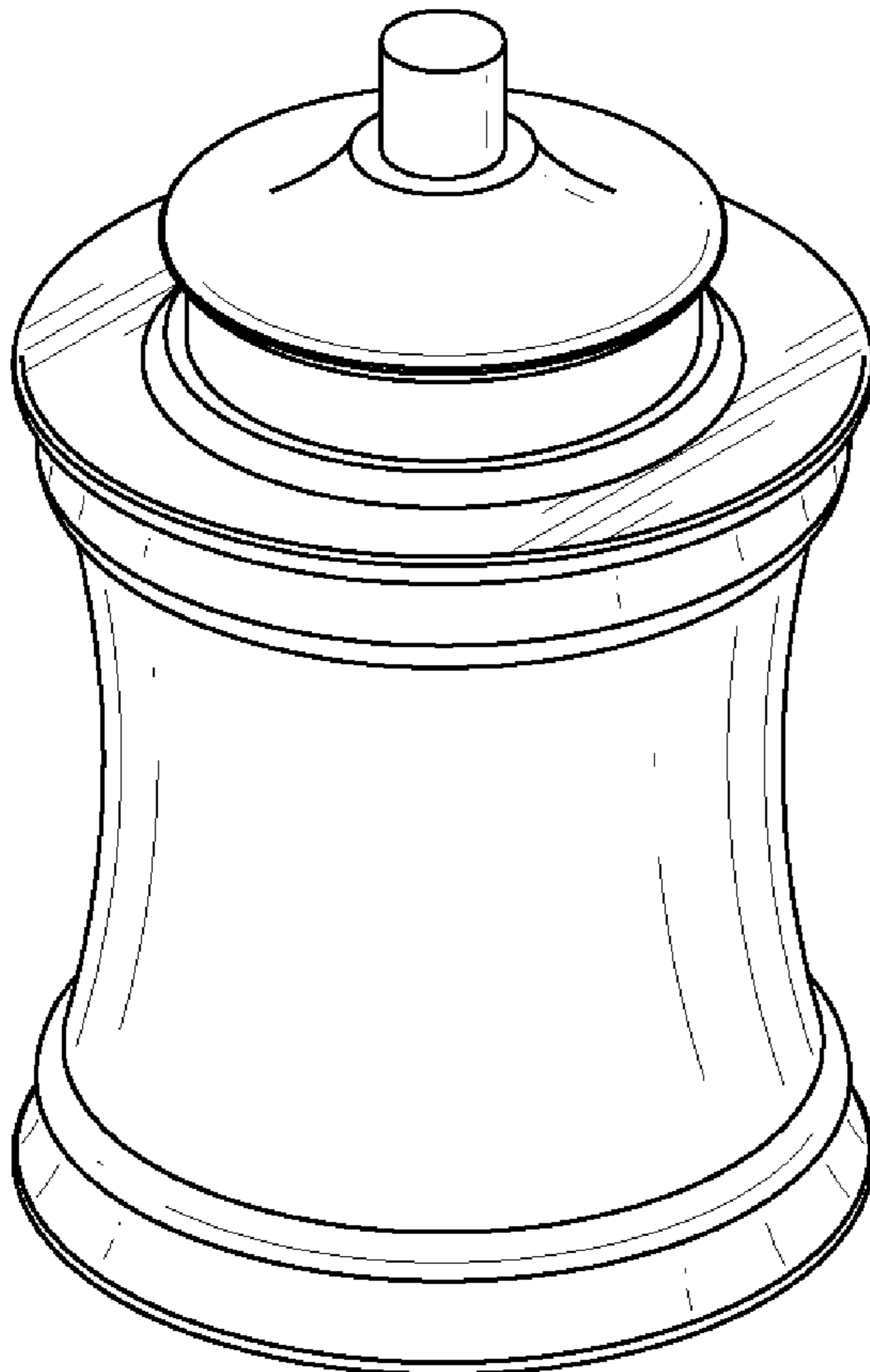

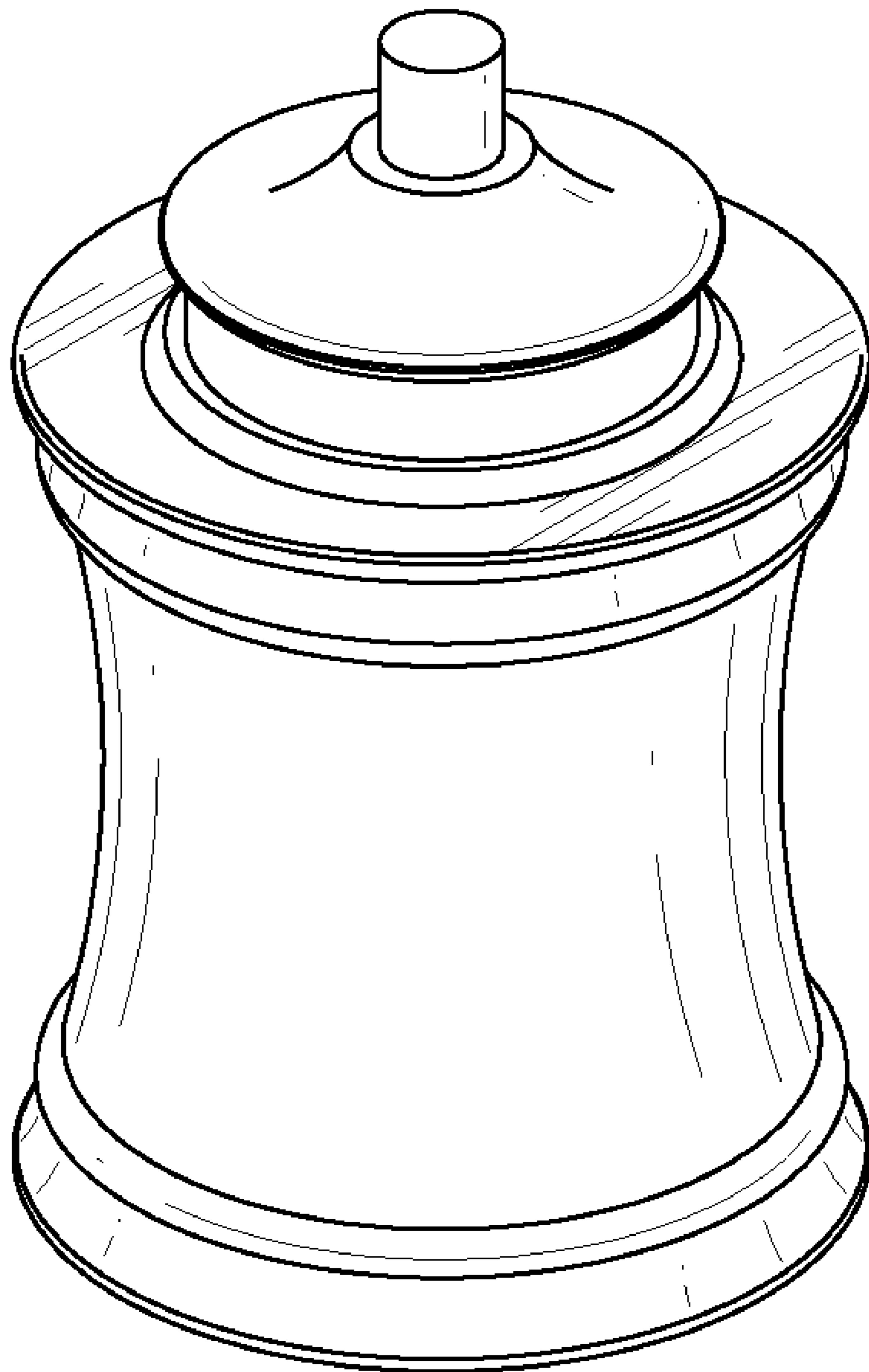

FIG. 1

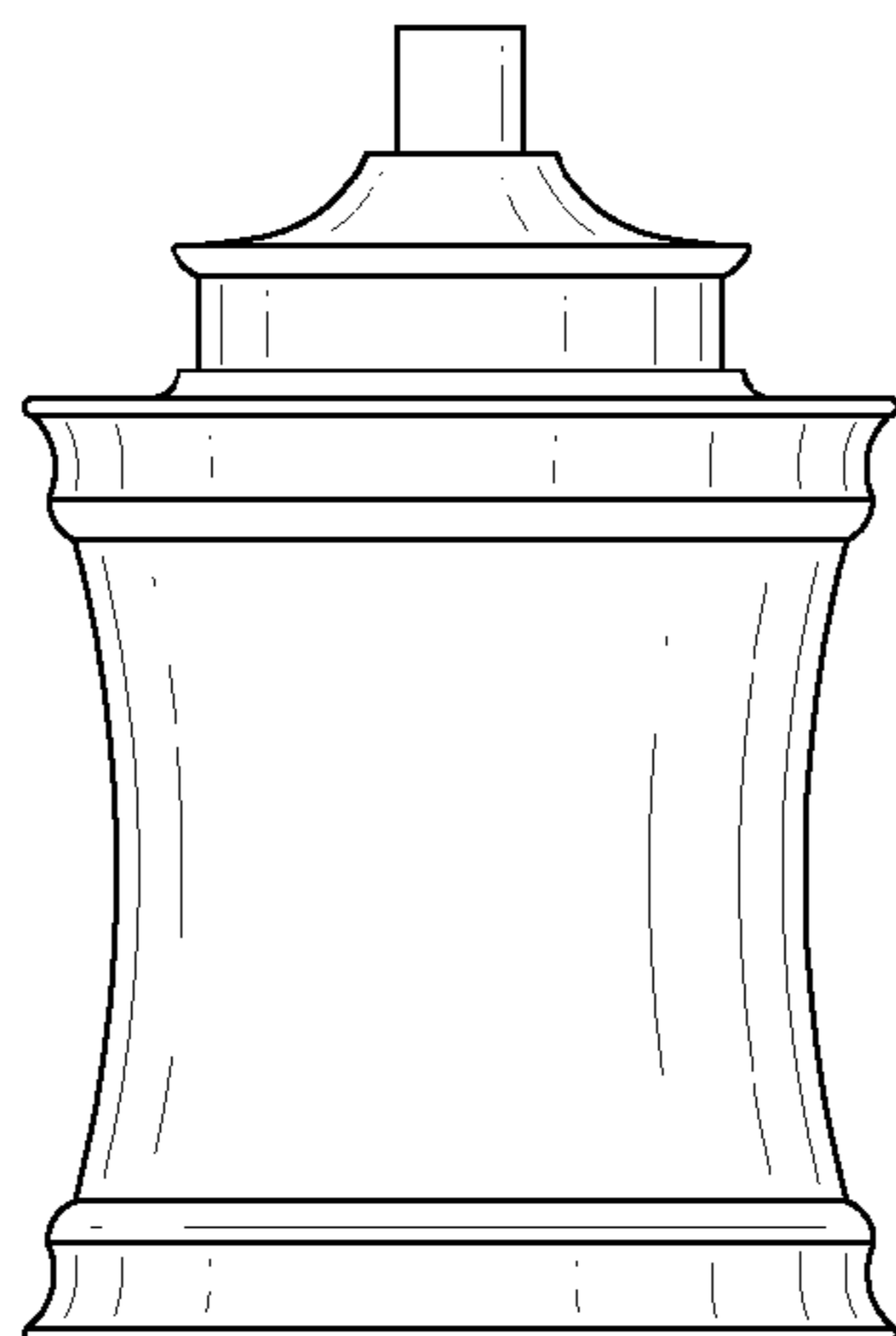

FIG. 2

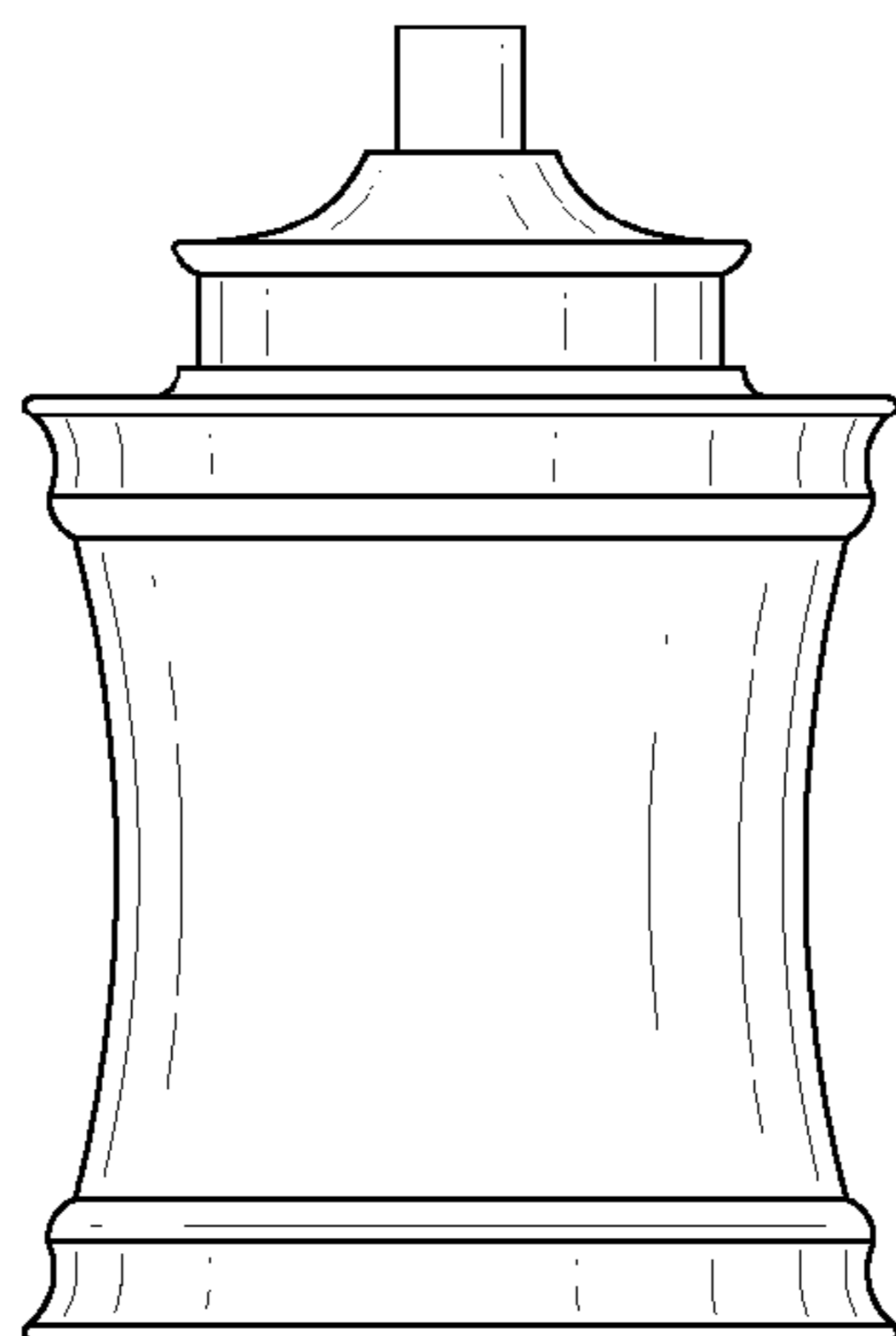

FIG. 3

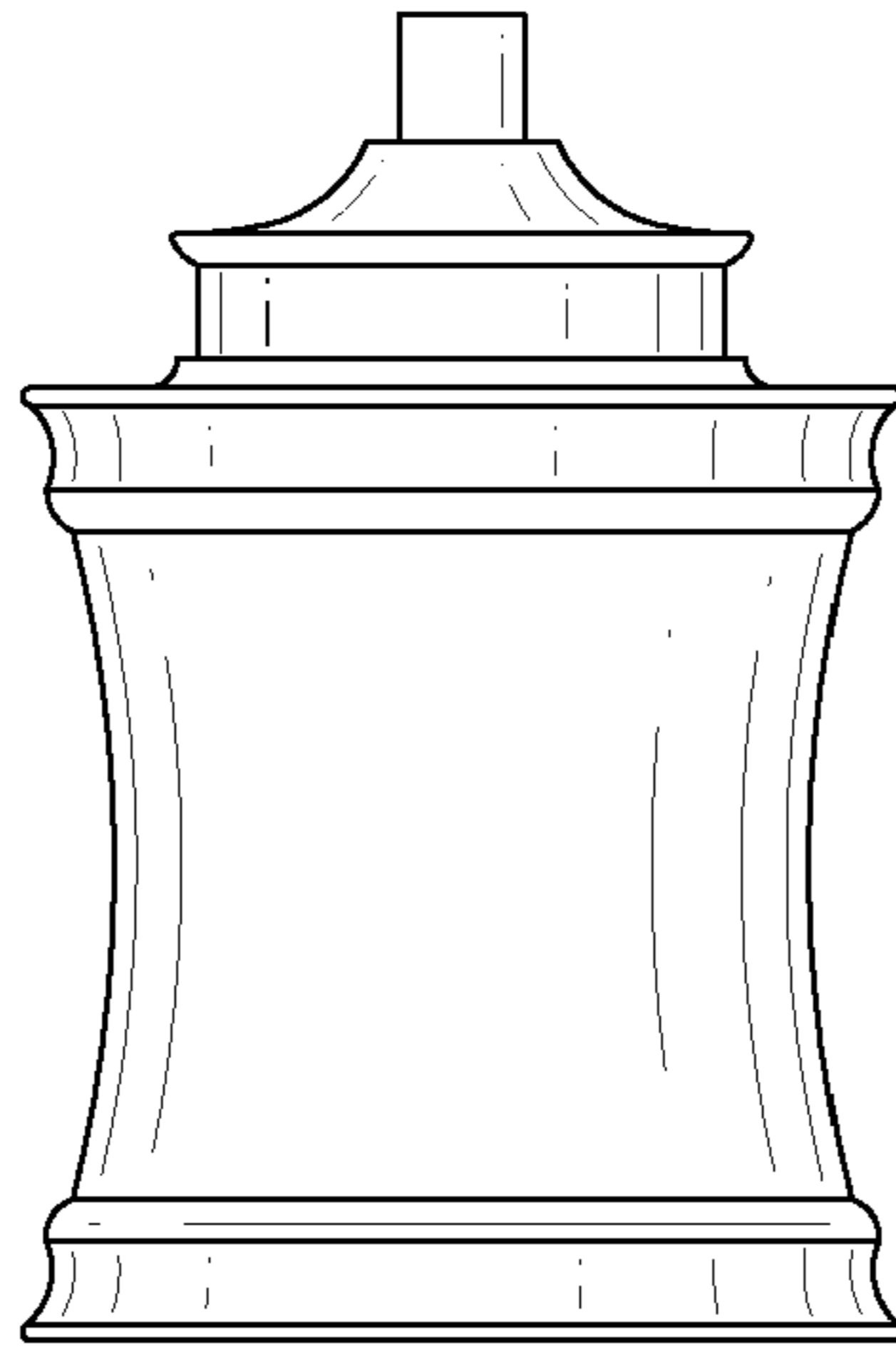

FIG. 4

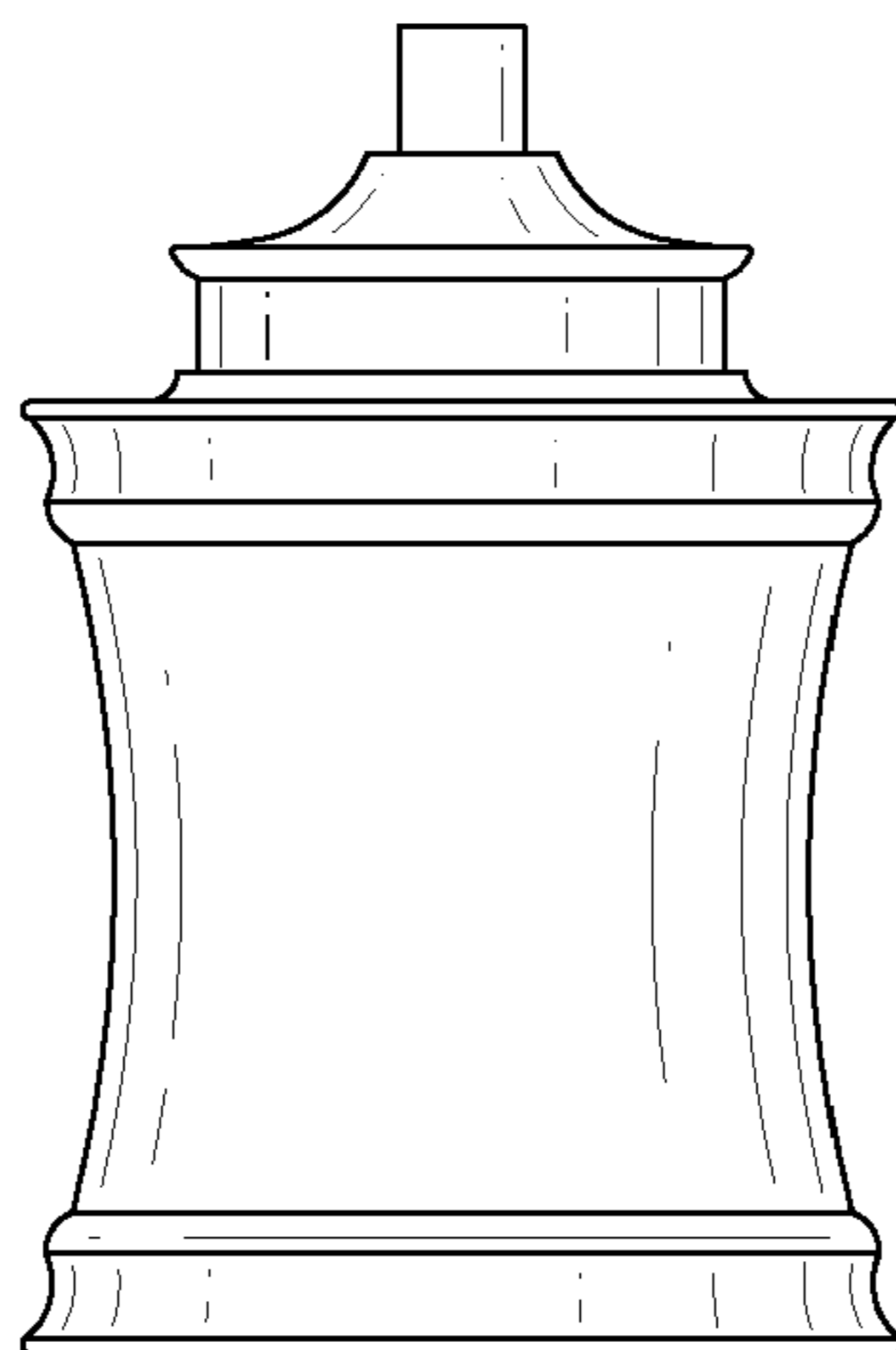

FIG. 5

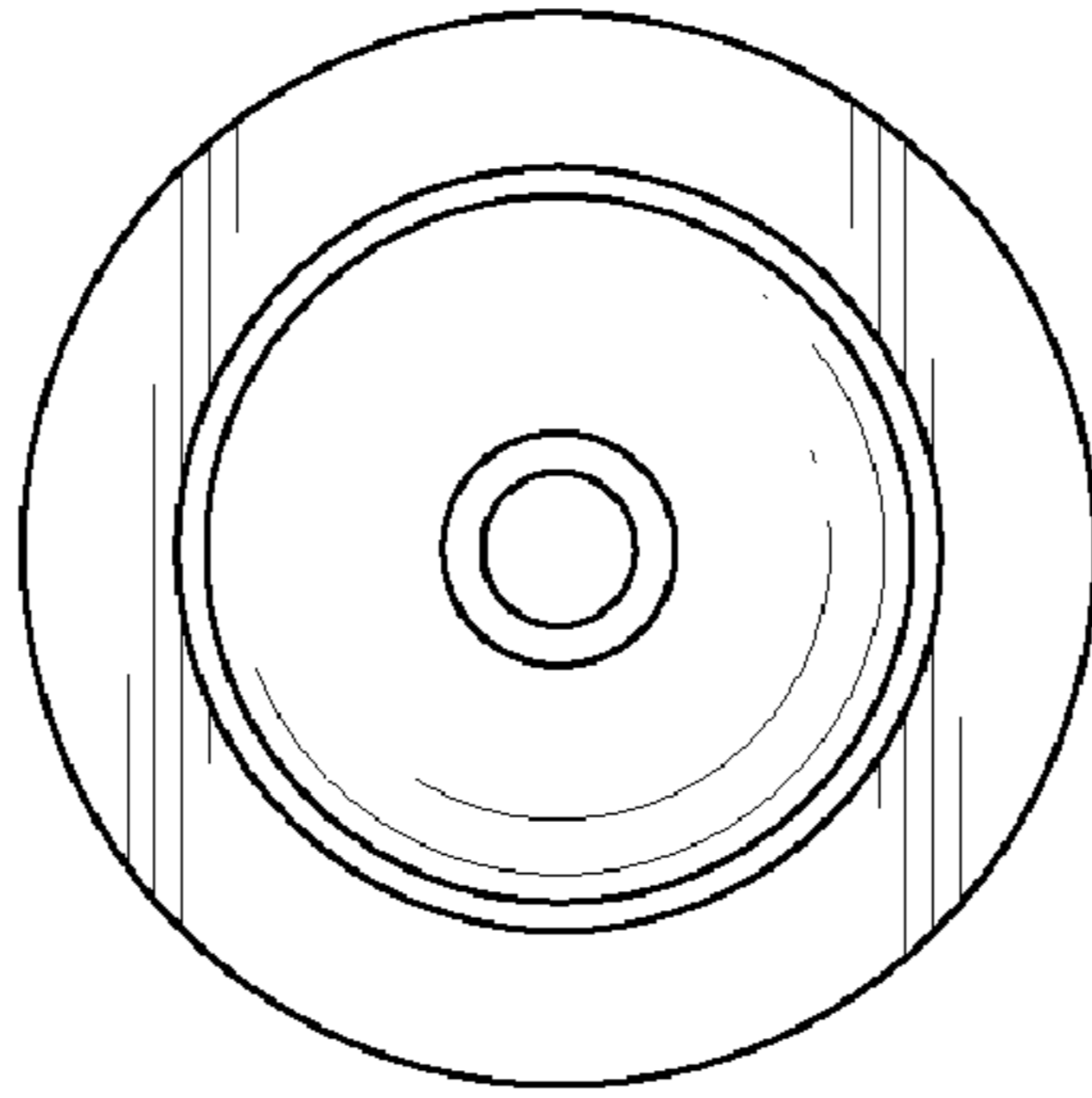

FIG. 6

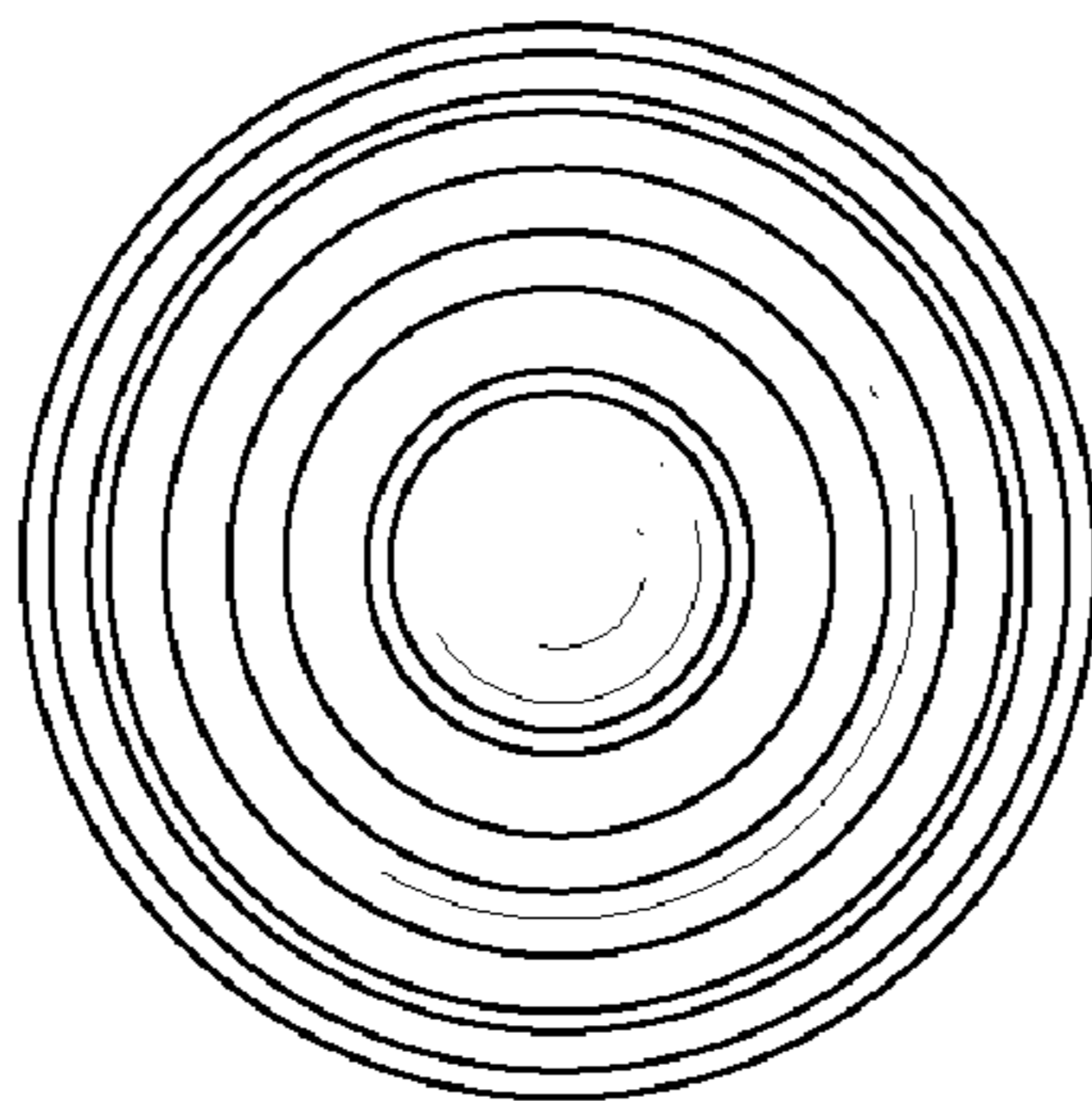

FIG. 7