



US00D626104S

(12) **United States Design Patent**
Tan

(10) **Patent No.:** **US D626,104 S**
(45) **Date of Patent:** **** Oct. 26, 2010**

(54) **MOBILE PHONE WITH REMOVABLE COVER**

(75) Inventor: **Kwang Beng Tan**, Singapore (SG)

(73) Assignee: **Sony Ericsson Mobile Communications AB**, Lund (SE)

(**) Term: **14 Years**

(21) Appl. No.: **29/336,503**

(22) Filed: **May 5, 2009**

(30) **Foreign Application Priority Data**

Nov. 21, 2008	(EM)	001043772-0001
Nov. 21, 2008	(EM)	001043772-0002
Nov. 21, 2008	(EM)	001043772-0003

(51) **LOC (9) Cl.** **14-03**

(52) **U.S. Cl.** **D14/138 AB**

(58) **Field of Classification Search** D14/138 AB,
D14/496, 341, 345, 346, 203.3, 203.4, 203.7,
D14/248; 455/575.3; D21/517; 379/433.13
See application file for complete search history.

(56) **References Cited**

U.S. PATENT DOCUMENTS

D498,468 S *	11/2004	Seo	D14/138 AB
D502,161 S *	2/2005	Kim et al.	D14/138 AB
D508,029 S *	8/2005	Lee	D14/138 AB

(Continued)

OTHER PUBLICATIONS

Sony Ericsson W508 telephone, announced Jan. 2009, [online], [site visited Jun. 18, 2010]. Available from Internet, <URL: <http://www.gsmarena.com>>.*
Sony Ericsson W980 telephone, announced Feb. 2008, [online], [site visited Jun. 18, 2010]. Available from Internet, <URL: <http://www.gsmarena.com>>.*

(Continued)

Primary Examiner—Jeffrey D Asch
(74) *Attorney, Agent, or Firm*—Renner, Otto, Boisselle & Sklar, LLP

(57) **CLAIM**

The ornamental design for a mobile phone with removable cover, as shown and described.

DESCRIPTION

FIG. 1 is a front view of a mobile phone in a closed position showing my design;

FIG. 2 is a rear view thereof;

FIG. 3 is a left side view thereof;

FIG. 4 is a right side view thereof;

FIG. 5 is a top view thereof;

FIG. 6 is a bottom view thereof;

FIG. 7 is a perspective view thereof;

FIG. 8 is a front view of the mobile phone in an open position showing my design;

FIG. 9 is rear view thereof;

FIG. 10 is a left side view thereof;

FIG. 11 is a right side view thereof;

FIG. 12 is a top view thereof;

FIG. 13 is a bottom view thereof;

FIG. 14 is a perspective view thereof;

FIG. 15 is a front view of the removable cover showing my new design;

FIG. 16 is a rear view thereof;

FIG. 17 is a right side view thereof, the left side view being a mirror image thereof; and,

FIG. 18 is a perspective view thereof.

The removable cover has been shown separated from the mobile phone in FIGS. 15-18 for convenience of illustration.

1 Claim, 9 Drawing Sheets

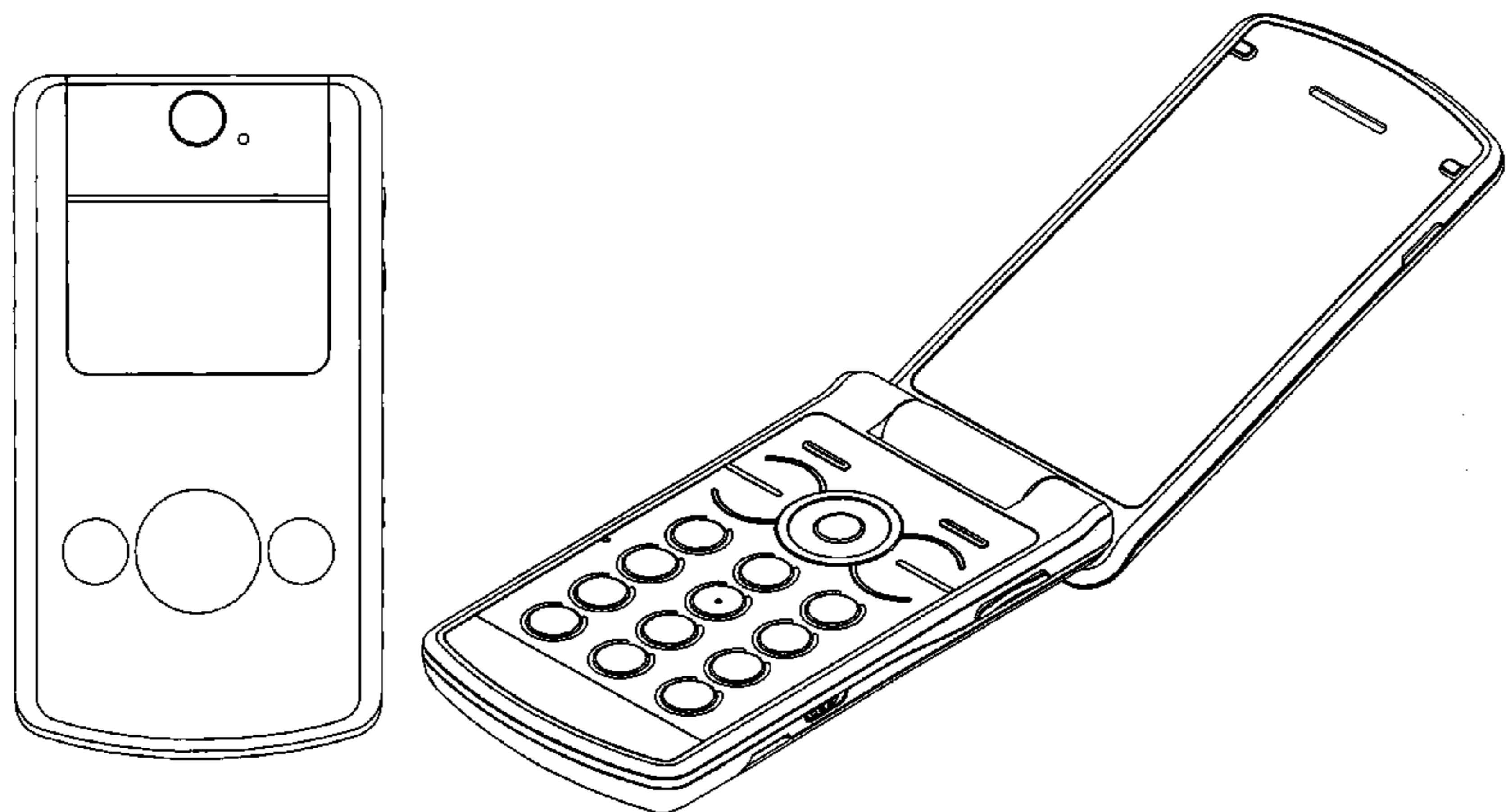

US D626,104 S

Page 2

U.S. PATENT DOCUMENTS

D517,517 S * 3/2006 Li et al. D14/138 AB
D551,642 S * 9/2007 Kim et al. D14/138 AB
D559,825 S * 1/2008 Park et al. D14/138 AB
D560,186 S * 1/2008 Kim et al. D14/138 AB
D568,280 S * 5/2008 Davis D14/138 AB
D568,857 S * 5/2008 Roh D14/138 AB
D578,094 S * 10/2008 Hong et al. D14/138 AB
D578,981 S * 10/2008 Park et al. D14/138 AB
D579,438 S * 10/2008 Kim et al. D14/138 AB
D581,896 S * 12/2008 Lee et al. D14/138 AB
D585,046 S * 1/2009 Yamada D14/138 AB
D586,802 S * 2/2009 Wun et al. D14/345
D592,169 S * 5/2009 Kim et al. D14/138 AB
D595,255 S * 6/2009 Cho D14/138 AB
D597,994 S * 8/2009 Koh et al. D14/138 AB
D598,000 S * 8/2009 Kim et al. D14/138 AB
D603,354 S * 11/2009 Kim et al. D14/138 AB
D605,159 S * 12/2009 Kim et al. D14/138 AB
D615,518 S * 5/2010 Ryu D14/138 AB

2007/0049357 A1* 3/2007 Daimon et al. 455/575.1

OTHER PUBLICATIONS

Telit X60i telephone, announced 2nd quarter 2004, [online], [site visited Jun. 18, 2010]. Available from Internet, <URL: <http://www.gsmarena.com>>.*
Sharp GX40 telephone, announced 2nd quarter 2004, [online], [site visited Jun. 18, 2010]. Available from Internet, <URL: <http://www.gsmarena.com>>.*
Samsung S200 telephone, announced 2003, [online], [site visited Jun. 18, 2010]. Available from Internet, <URL: <http://www.gsmarena.com>>.*
BenQ T51 telephone, announced Aug. 2007, [online], [site visited Jun. 18, 2010]. Available from Internet, <URL: <http://www.gsmarena.com>>.*
Philips Xenium 9@9q telephone, announced Jul. 2008, [online], [site visited Jun. 18, 2010]. Available from Internet, <URL: <http://www.gsmarena.com>>.*
BenQ M350 telephone, announced 2nd quarter 2005, [online], [site visited Jun. 18, 2010]. Available from Internet, <URL: <http://www.gsmarena.com>>.*

* cited by examiner

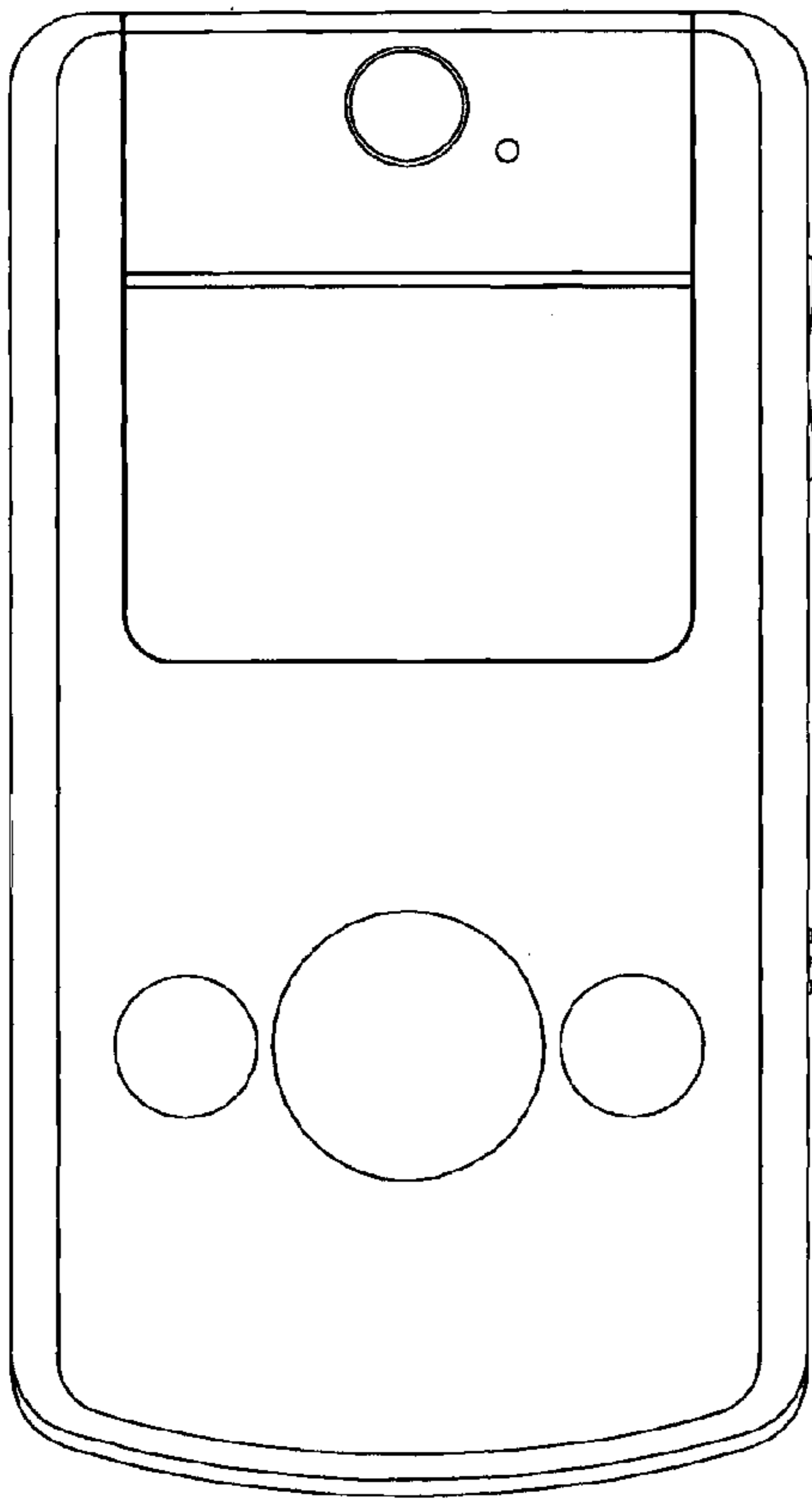

FIG. 1

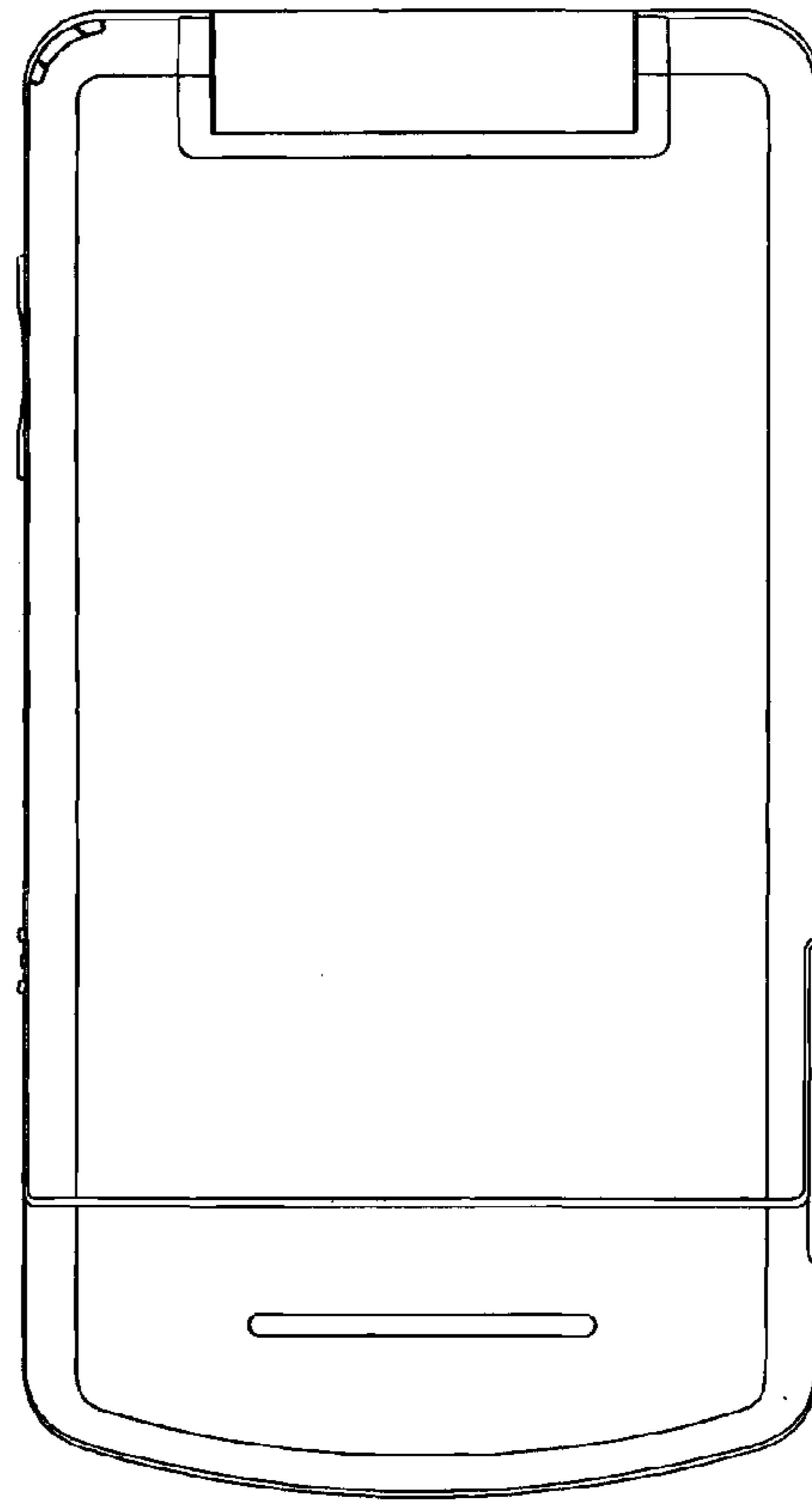

FIG. 2

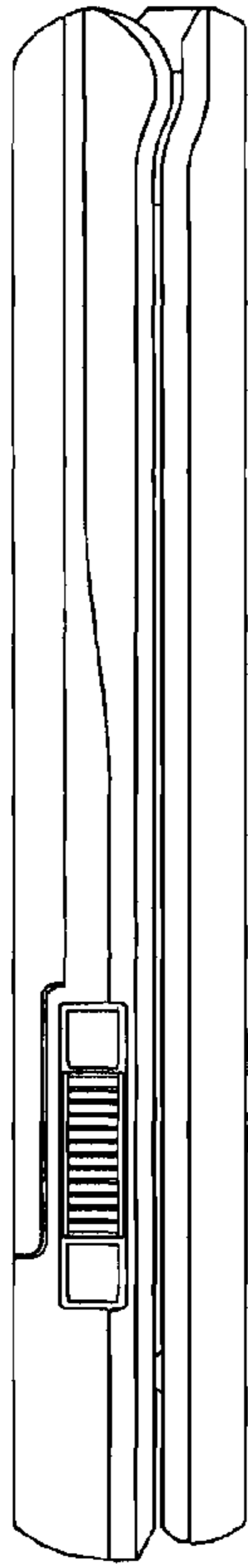

FIG. 3

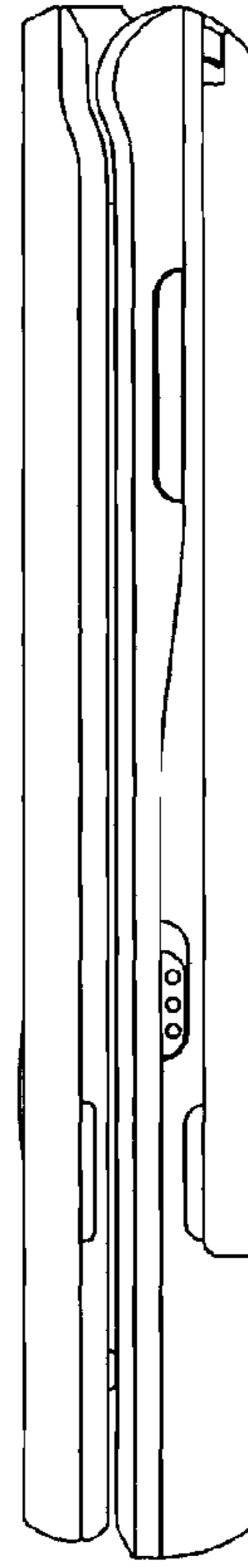

FIG. 4

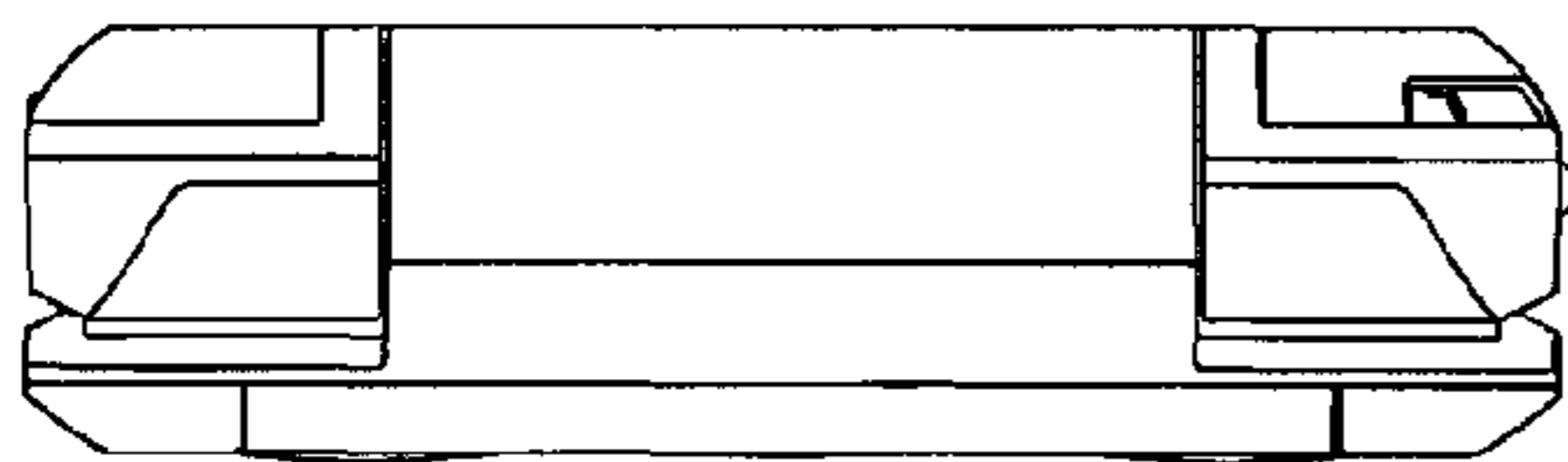

FIG. 5

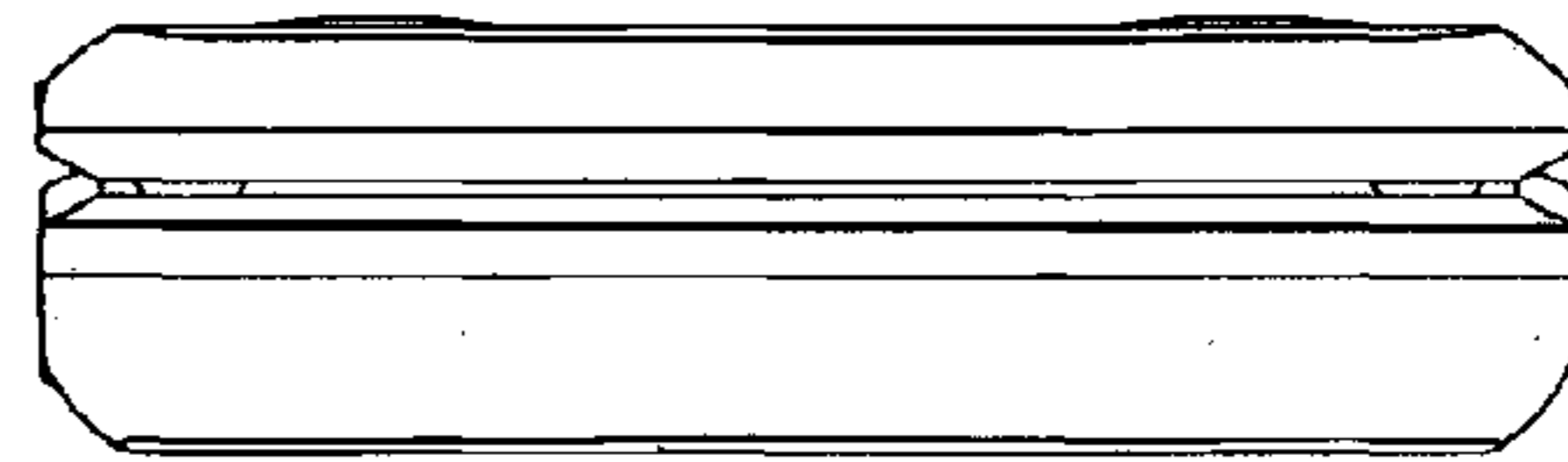

FIG. 6

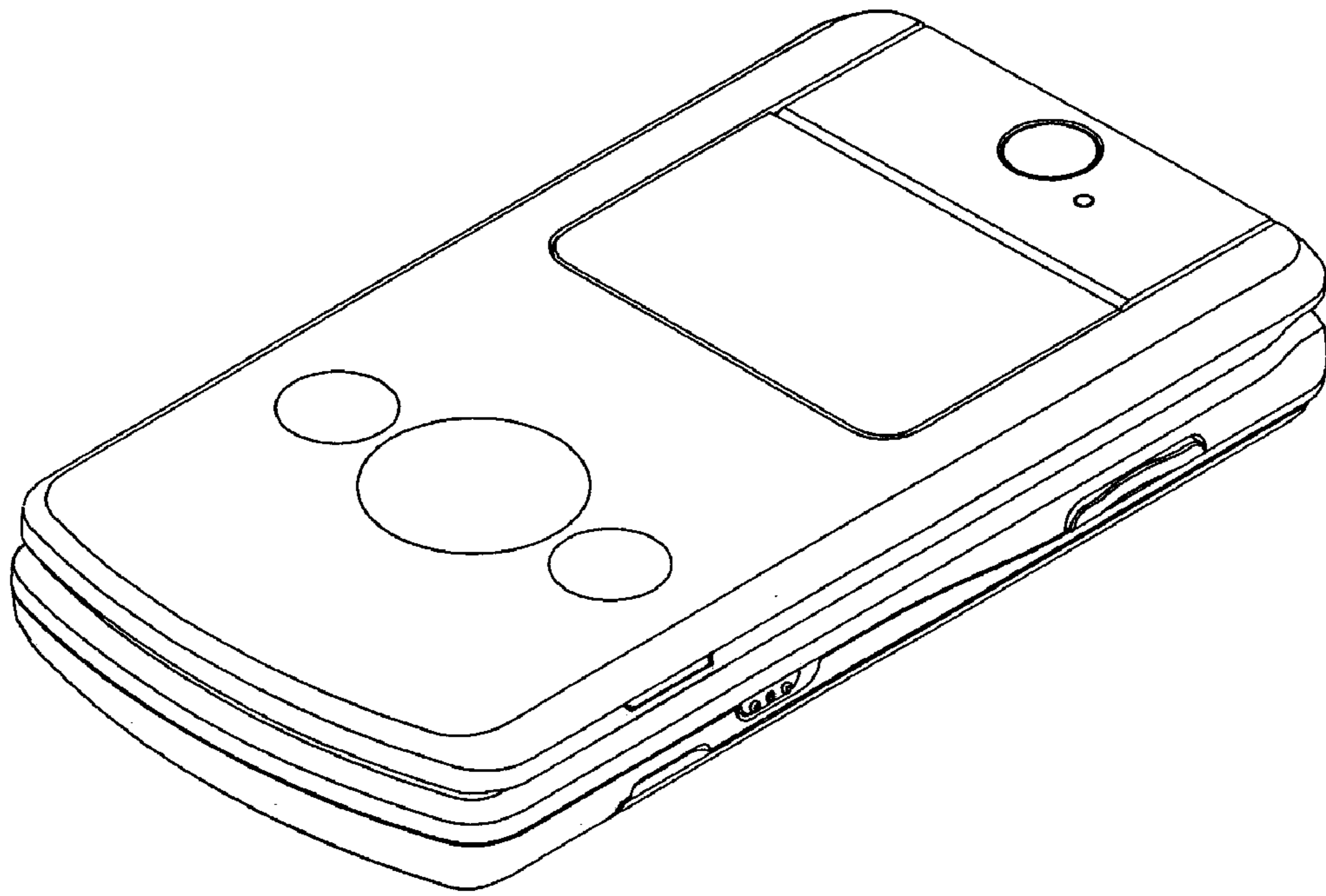

FIG. 7

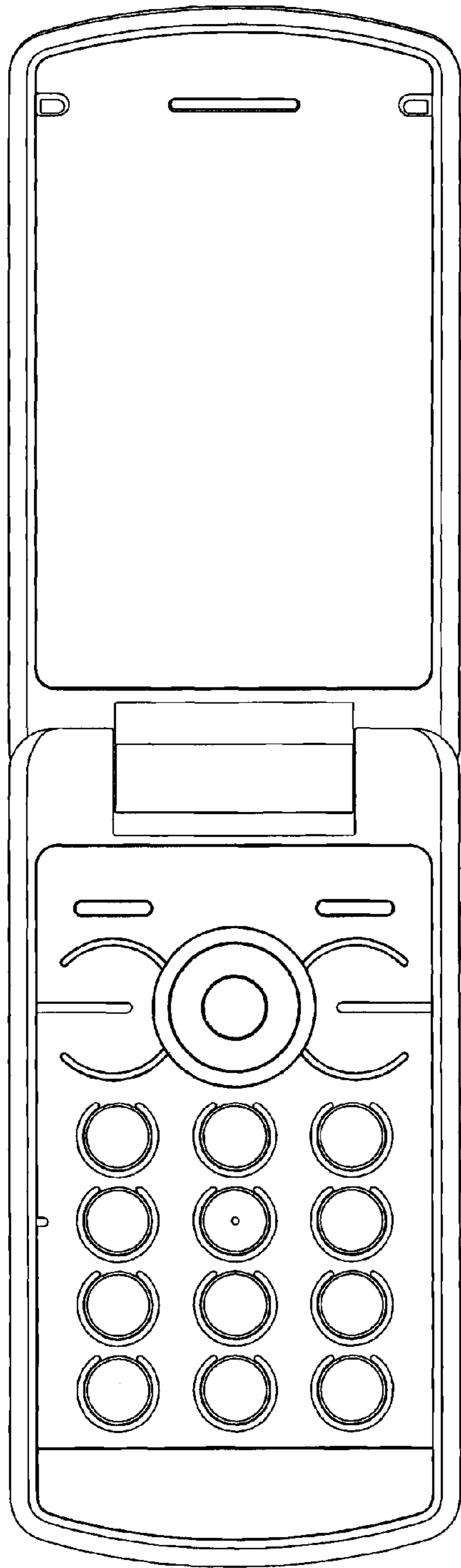

FIG. 8

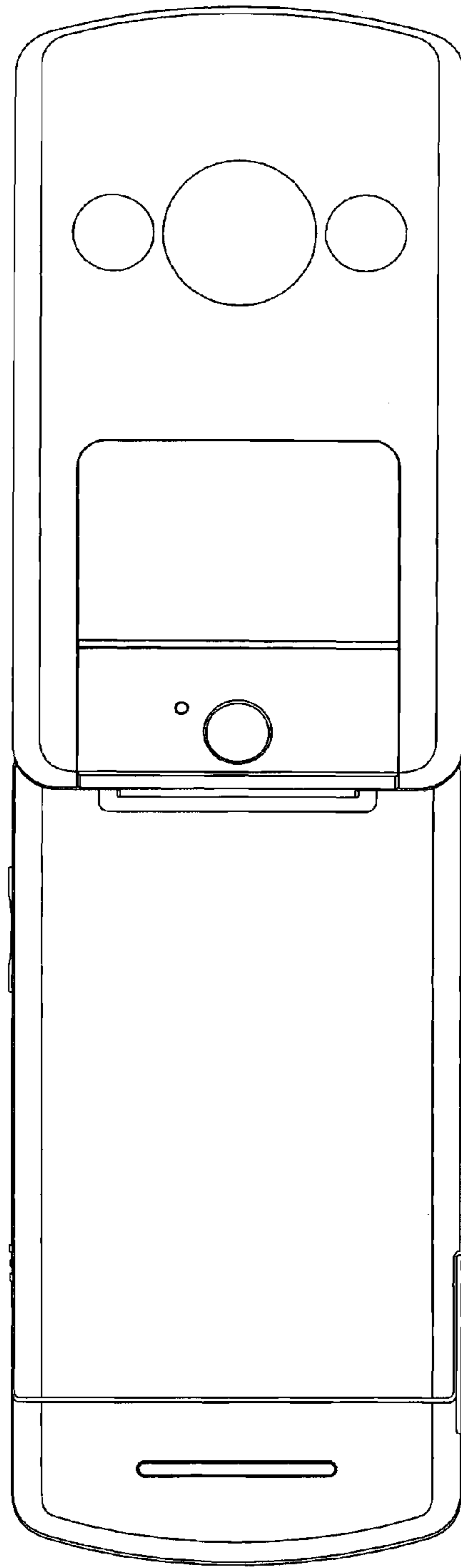

FIG. 9

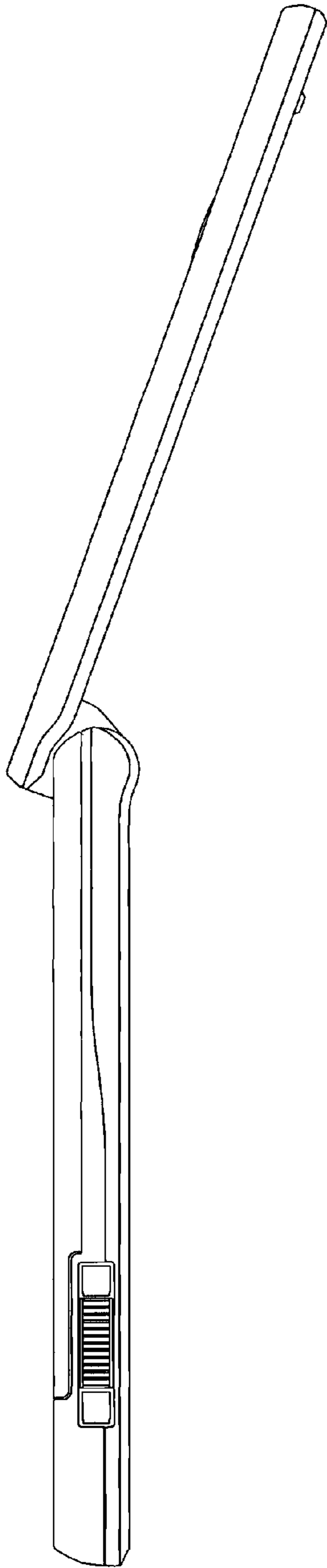

FIG. 10

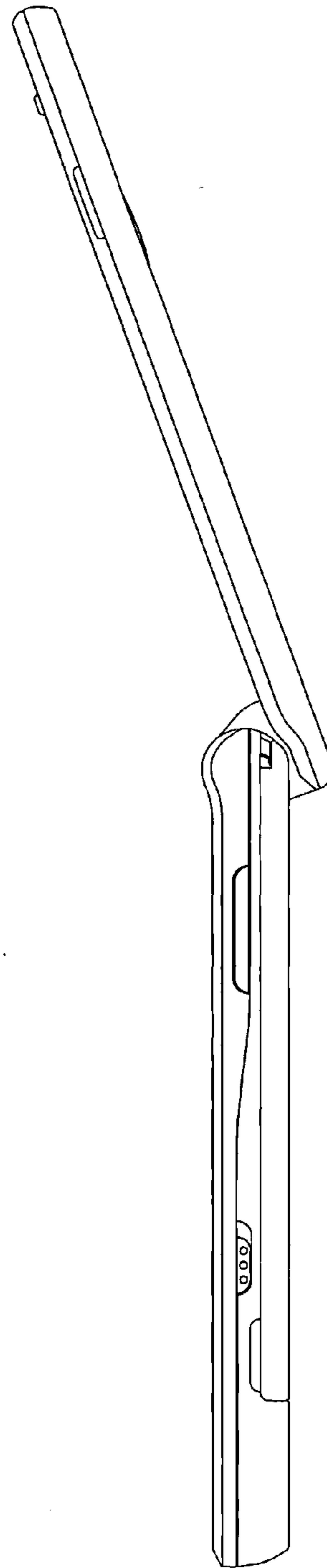

FIG. 11

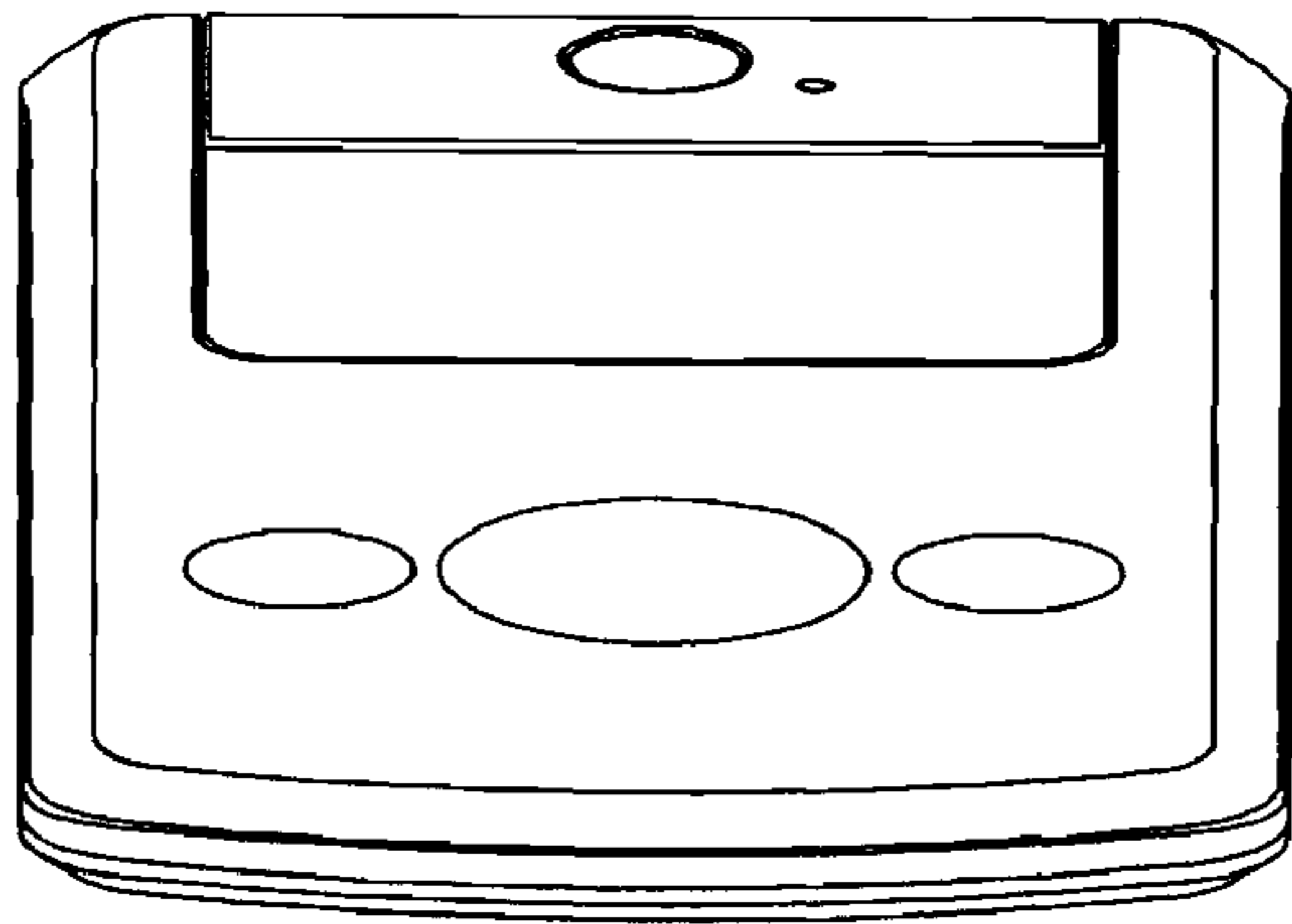

FIG. 12

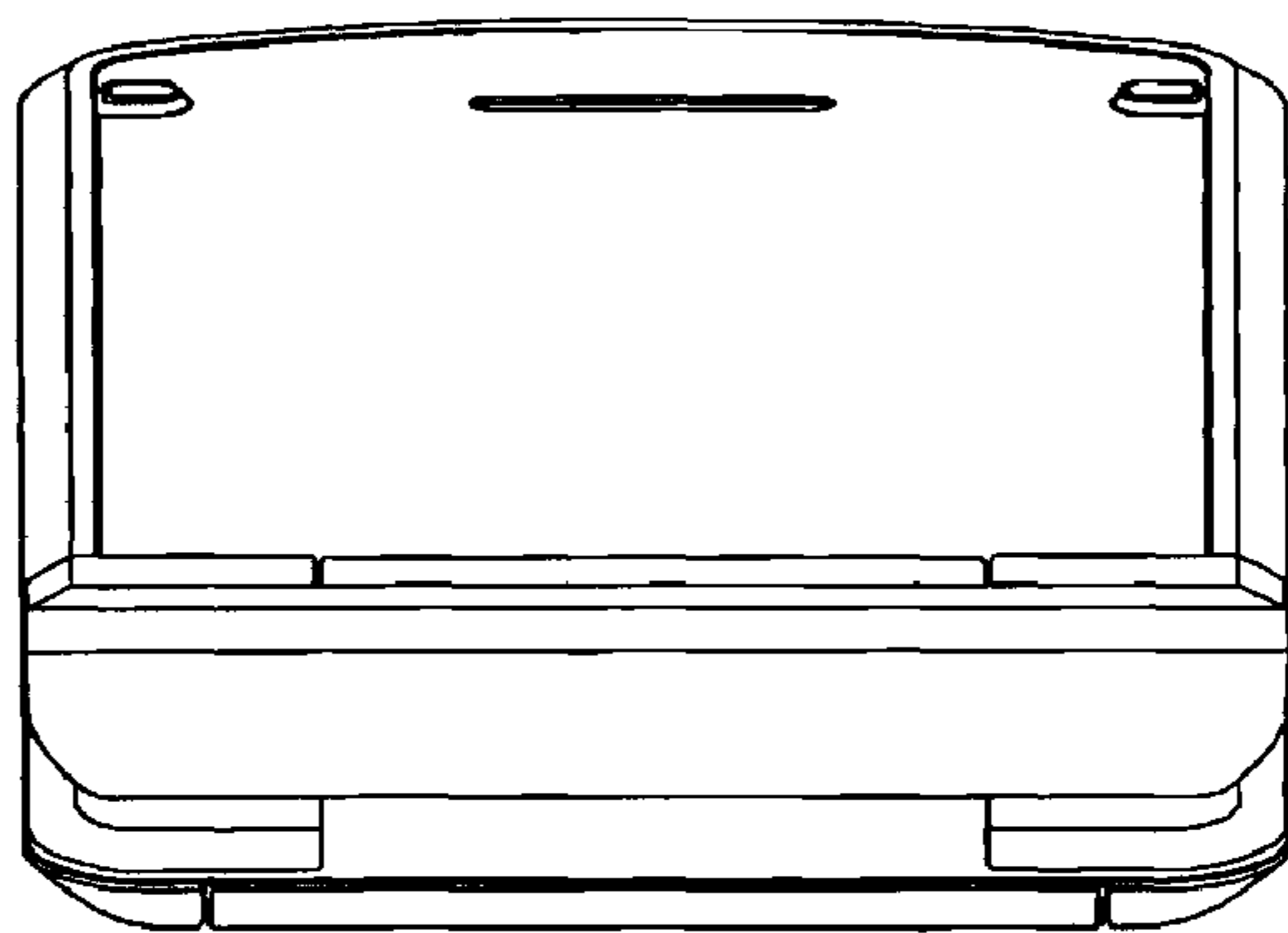

FIG. 13

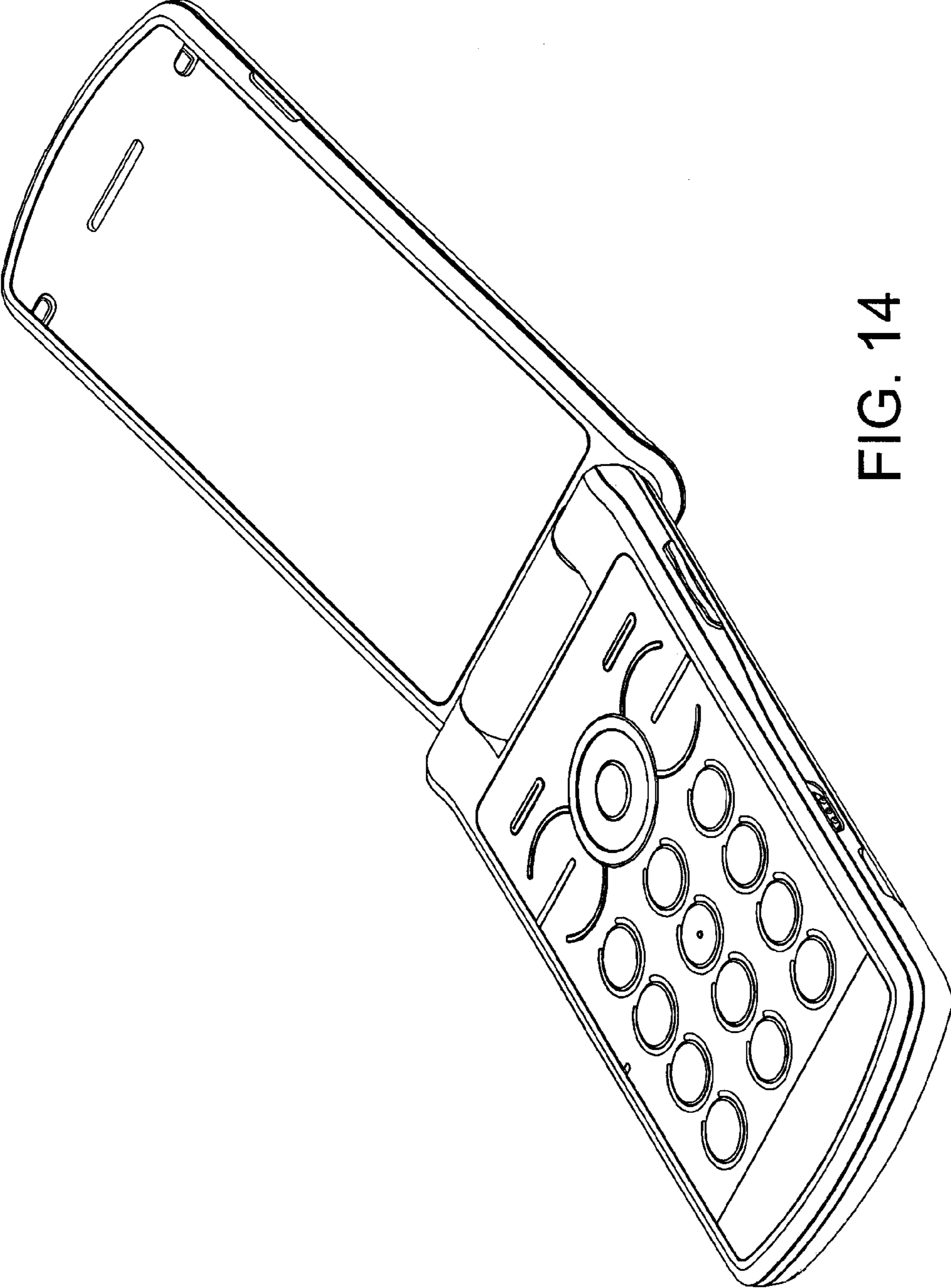

FIG. 14

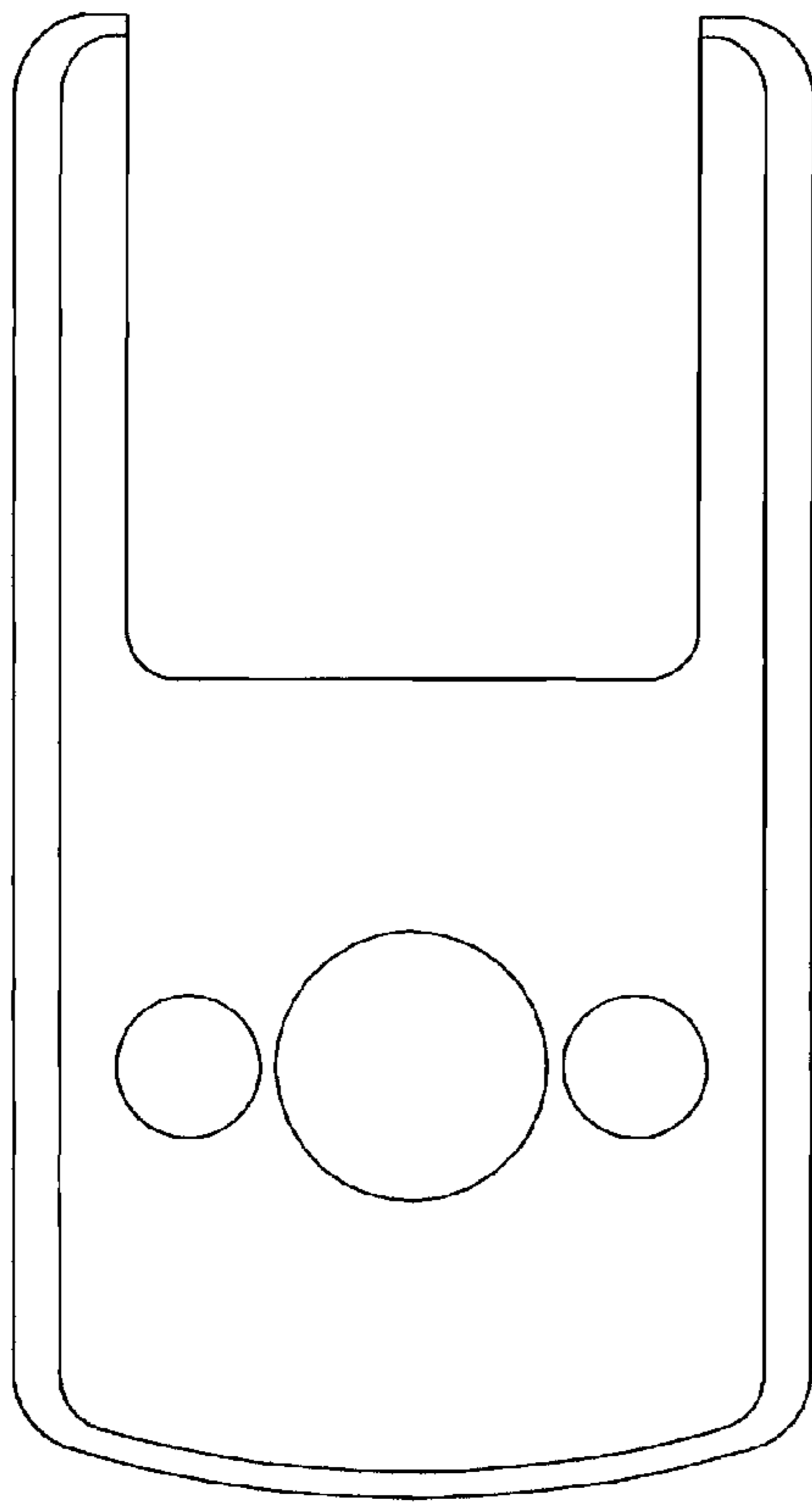

FIG. 15

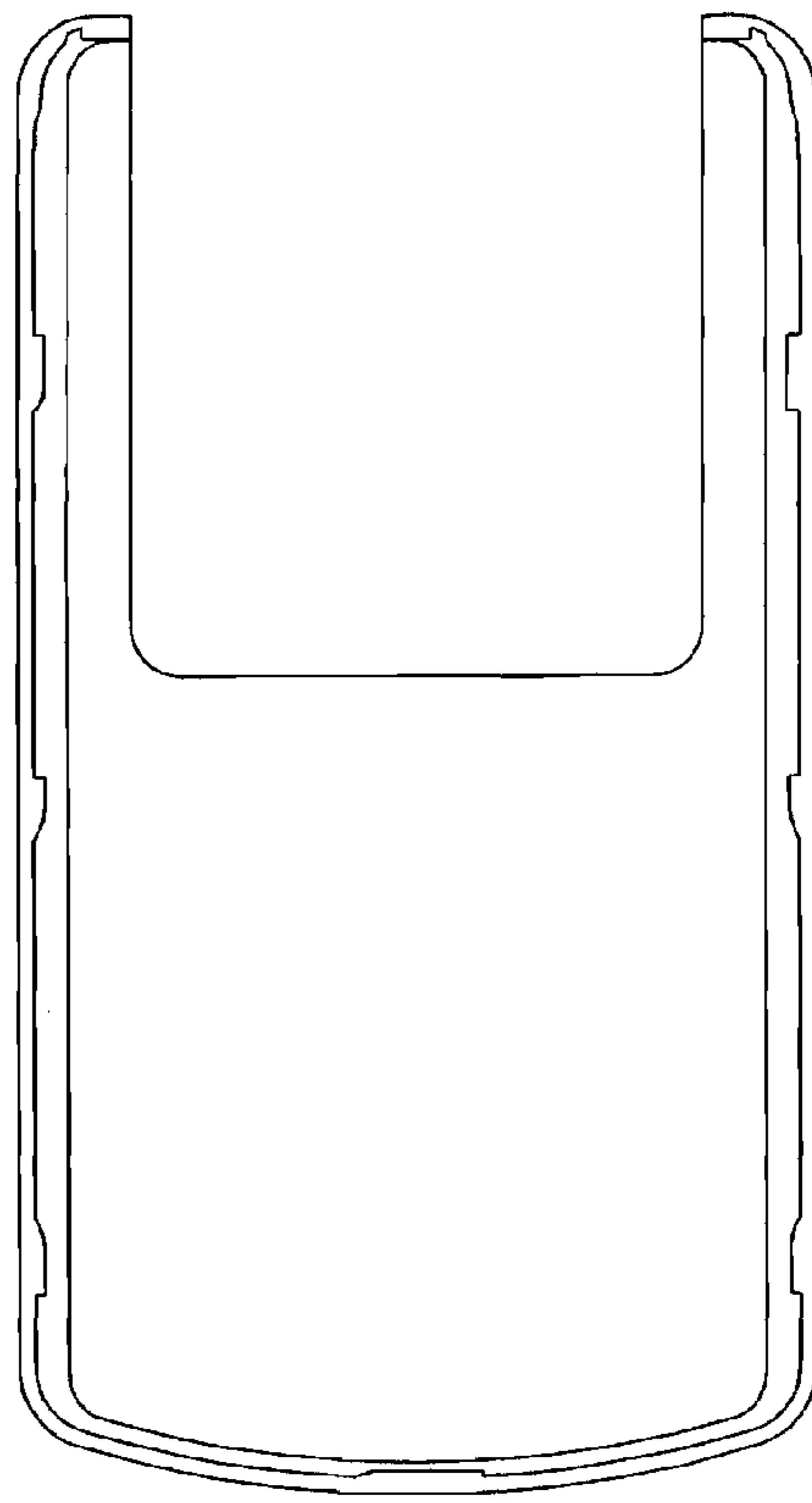

FIG. 16



FIG. 17

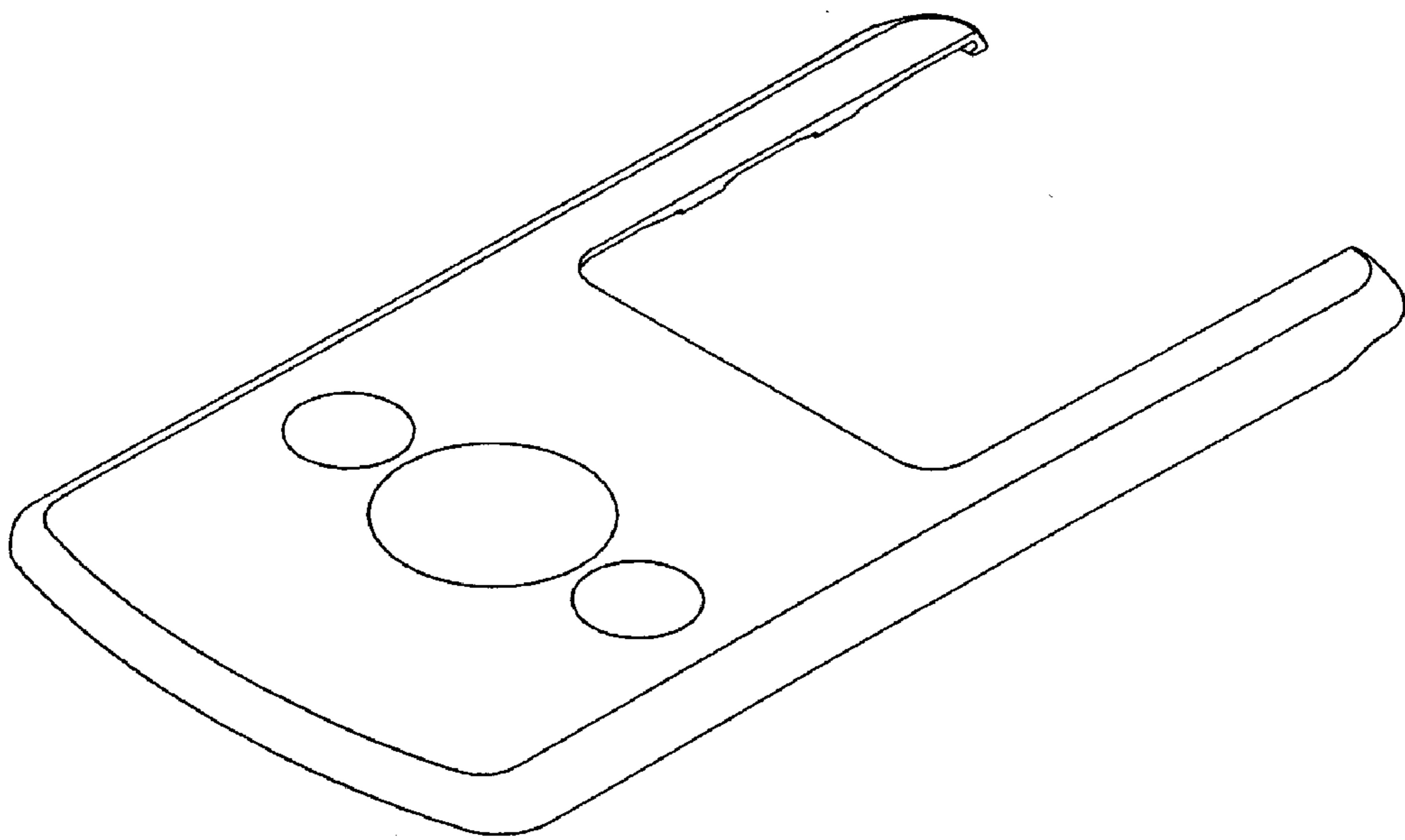

FIG. 18