



US00D625957S

(12) **United States Design Patent**  
**Minns**

(10) **Patent No.:** **US D625,957 S**

(45) **Date of Patent:** **\*\* Oct. 26, 2010**

(54) **TRAY**

(76) **Inventor:** **Kathy Minns**, 1101 Hillside Dr.,  
Birmingham, MI (US) 48009

(\*\*) **Term:** **14 Years**

(21) **Appl. No.:** **29/355,069**

(22) **Filed:** **Feb. 2, 2010**

(51) **LOC (9) Cl.** ..... **07-01**

(52) **U.S. Cl.** ..... **D7/550.1**

(58) **Field of Classification Search** ..... D7/550.1,  
D7/500, 566, 602, 553.6, 553.8; D6/449,  
D6/396; D3/307, 315-316; 211/126.1, 71.01,  
211/85.18; 220/574, 571

See application file for complete search history.

(56) **References Cited**

**U.S. PATENT DOCUMENTS**

1,518,618	A	12/1924	Waters, Jr.	
1,631,631	A	6/1927	Gerlinger	
1,696,221	A	12/1928	Tubbs	
2,790,269	A	4/1957	Coleman, Jr.	
3,386,590	A *	6/1968	Gretz	211/189
3,526,992	A	9/1970	Foster	
4,133,922	A	1/1979	Smith	
D251,652	S *	4/1979	Molloy	D7/553.7
4,164,058	A	8/1979	Barna	
4,380,885	A	4/1983	Komagata	
D278,114	S *	3/1985	Prophet et al.	D7/553.7
4,543,297	A	9/1985	Saurenman	
D333,057	S *	2/1993	Shimonovitch	D6/495
5,299,382	A	4/1994	Carmichael	

5,338,244	A	8/1994	Huang	
D352,367	S *	11/1994	Gryzlak	D30/123
D359,418	S *	6/1995	Sicard et al.	D7/553.6
D388,737	S	1/1998	Branson	
5,750,279	A *	5/1998	Carolan et al.	429/32
6,017,132	A	1/2000	Miller et al.	
6,079,154	A	6/2000	Farwell	
6,394,932	B1 *	5/2002	Chu	482/38
D494,024	S *	8/2004	Welch	D7/637
D537,892	S *	3/2007	Moses	D21/662

\* cited by examiner

*Primary Examiner*—Elizabeth A Albert

*Assistant Examiner*—Kelly A Donnelly

(74) *Attorney, Agent, or Firm*—Carrier, Blackman &  
Associates P.C.; Joseph P. Carrier; William D. Blackman

(57) **CLAIM**

The ornamental design for a tray, substantially as shown.

**DESCRIPTION**

FIG. 1 is a perspective view of my new, original, and ornamental design for a tray;

FIG. 2 is a top plan view thereof;

FIG. 3 is a bottom plan view thereof;

FIG. 4 is a front plan view thereof;

FIG. 5 is a rear side plan view thereof;

FIG. 6 is a left side plan view thereof; and,

FIG. 7 is a sectional view of FIG. 2 thereof.

**1 Claim, 3 Drawing Sheets**

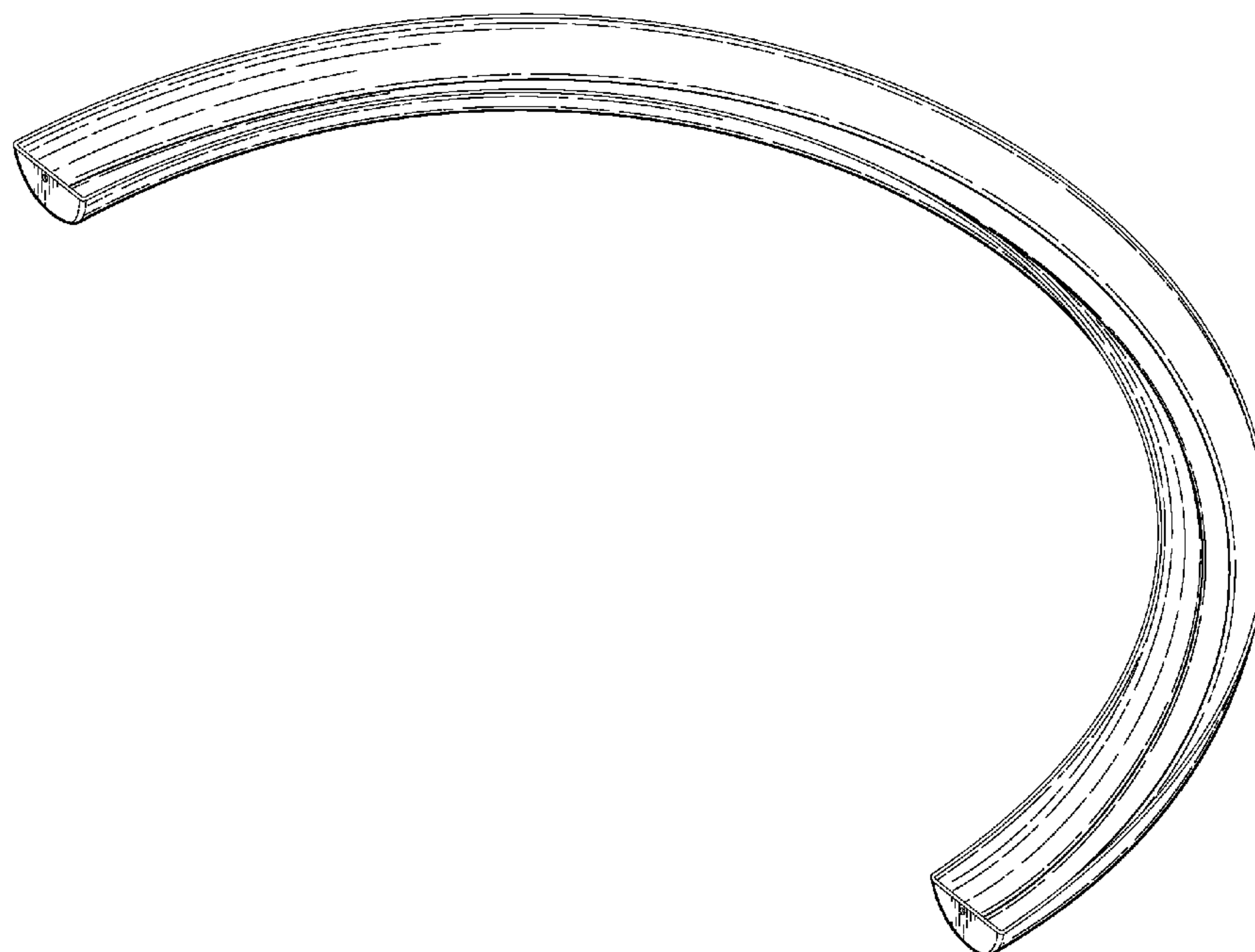

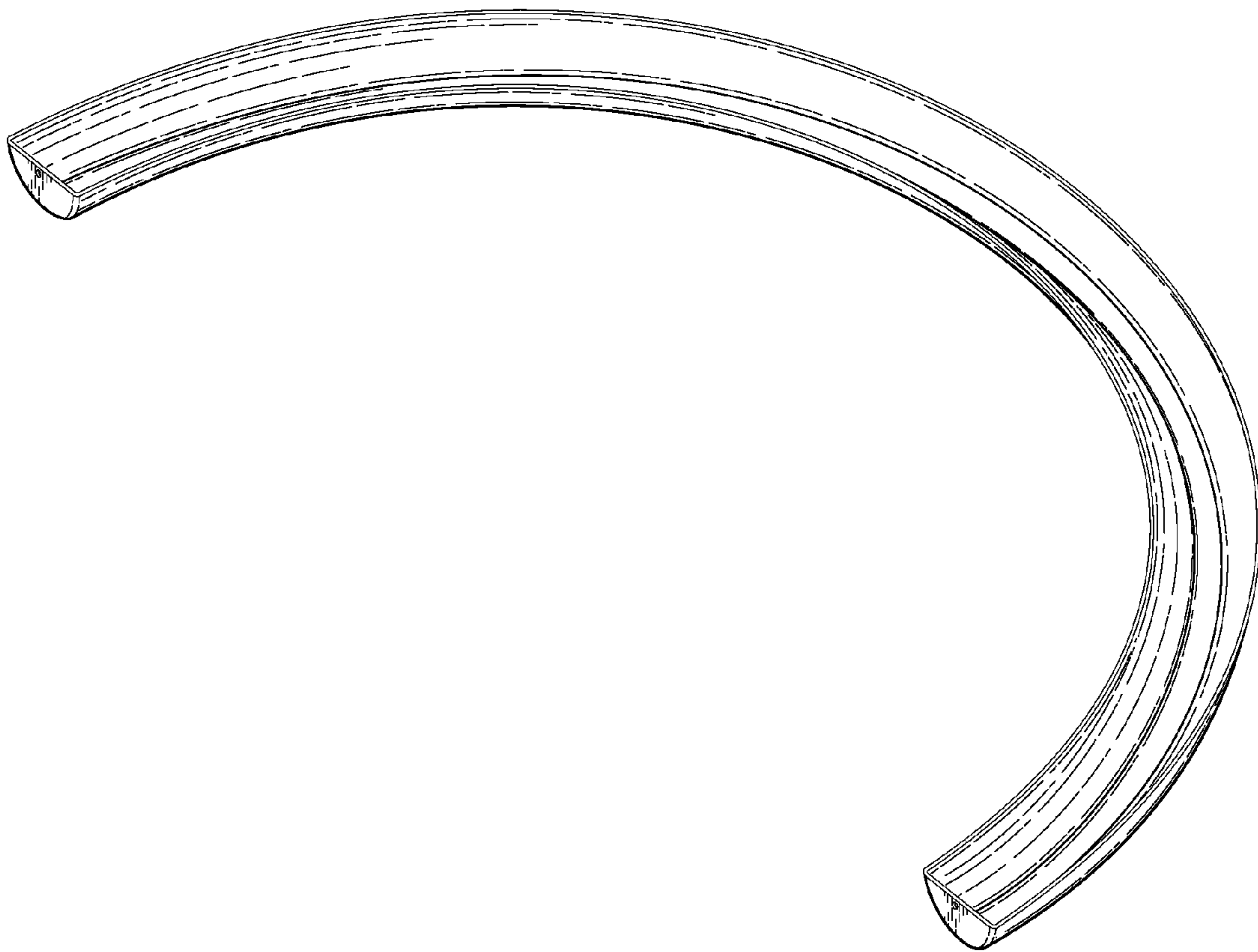

FIG. 1

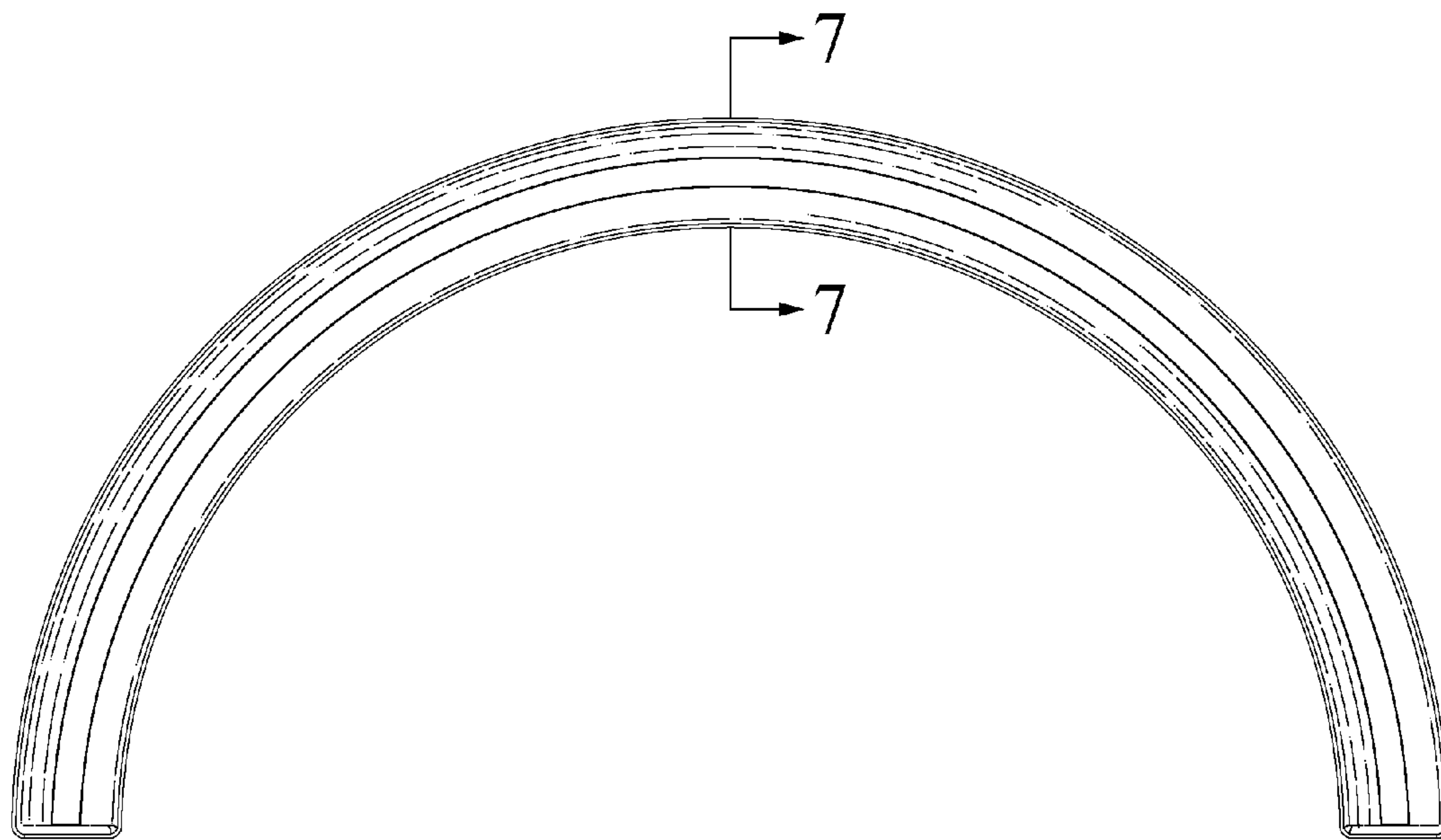

FIG. 2

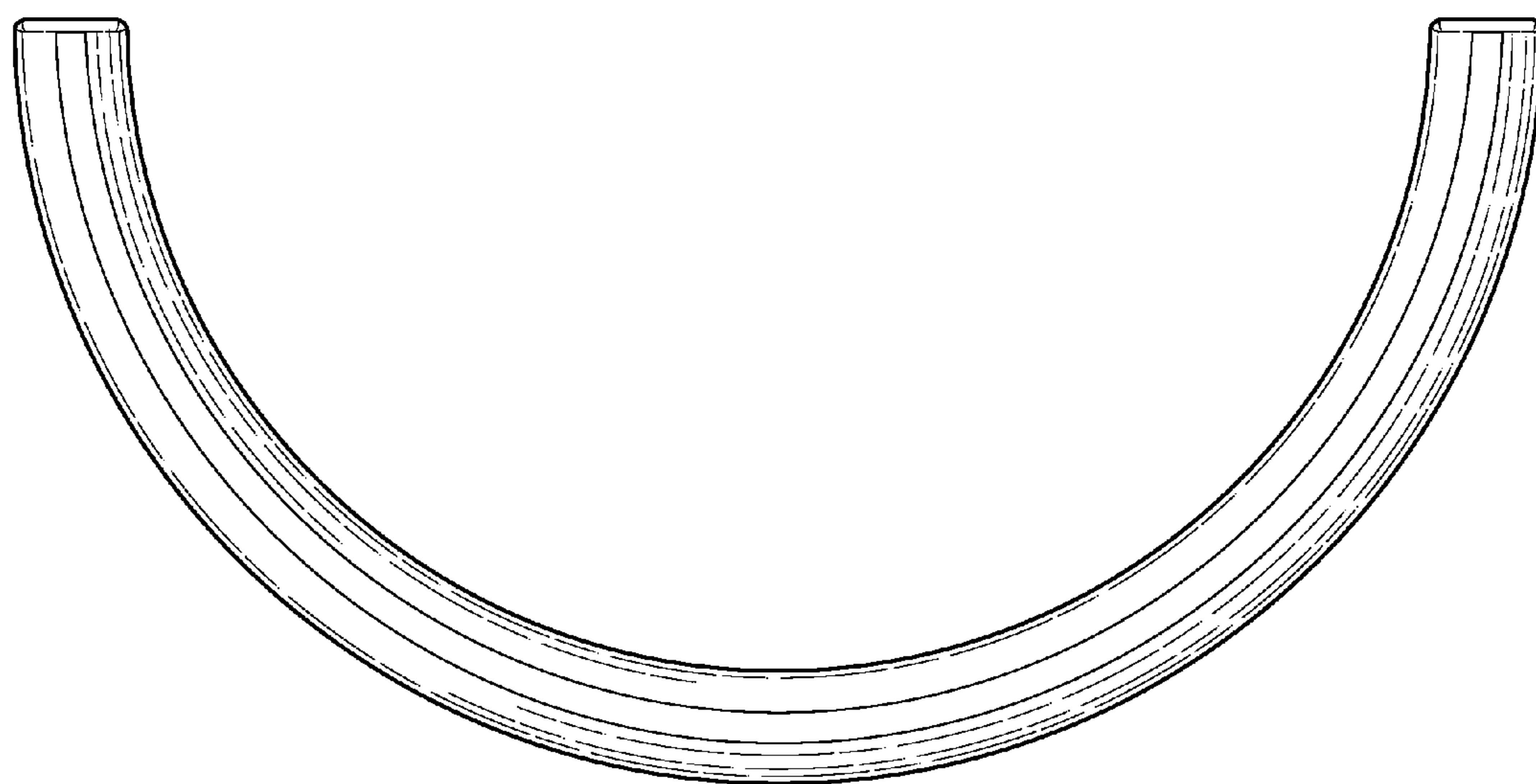

FIG. 3

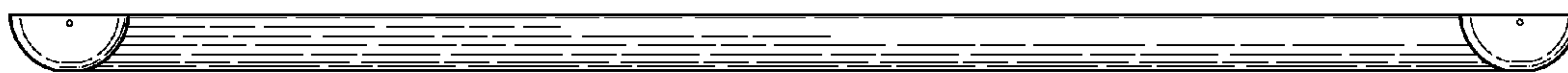

FIG. 4



FIG. 5

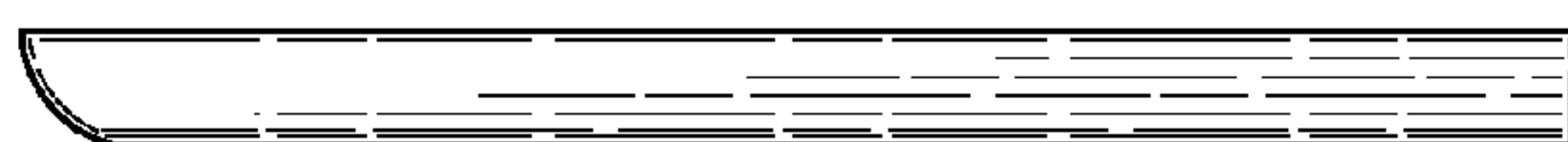

FIG. 6

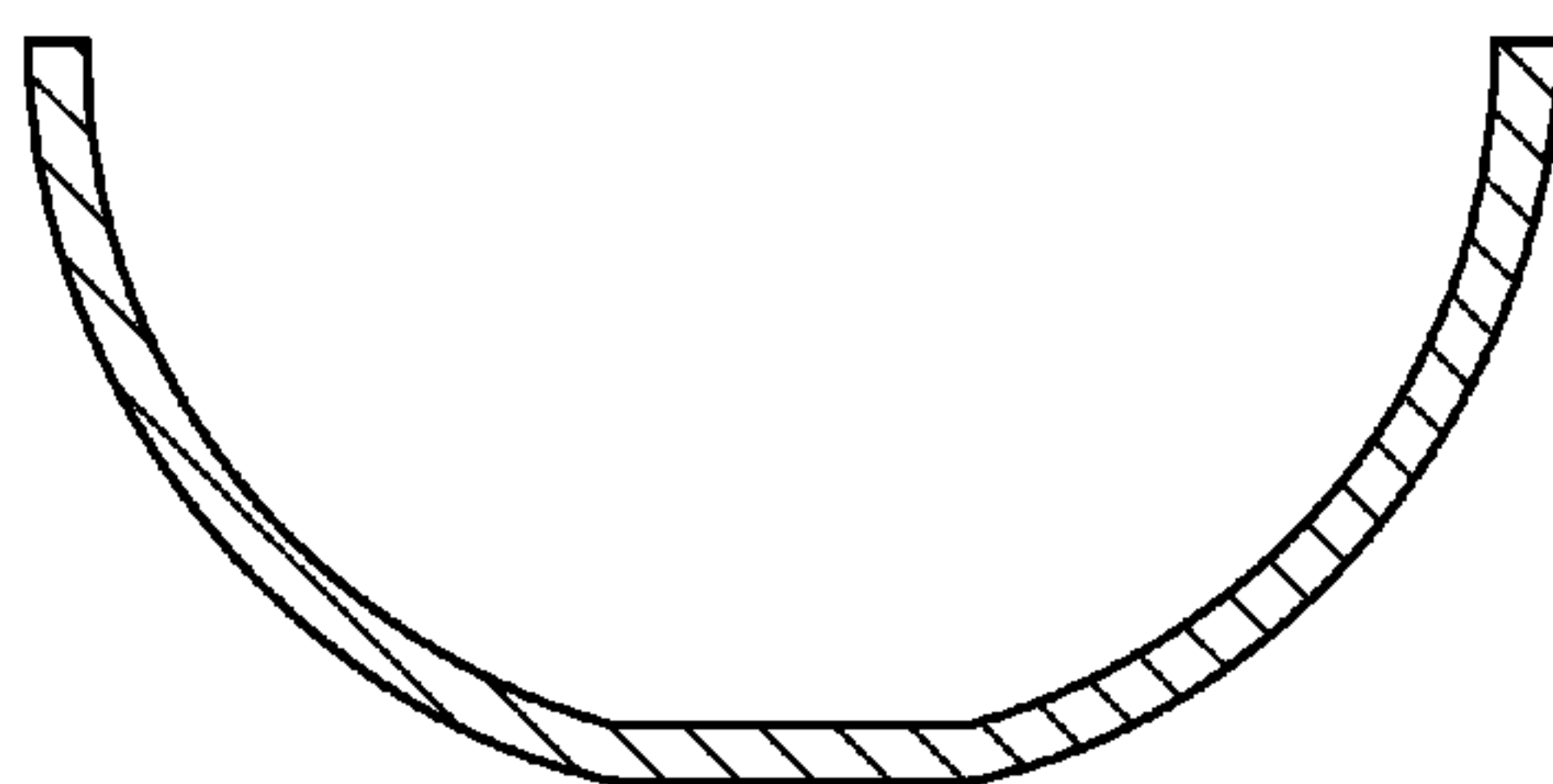

FIG. 7