



US00D625877S

(12) **United States Design Patent**  
**Hsu et al.**

(10) **Patent No.:** **US D625,877 S**  
(45) **Date of Patent:** **\*\* Oct. 19, 2010**

(54) **LIGHTING APPARATUS**

(75) Inventors: **Feng-Ting Hsu**, Tucheng (TW); **Yu-Ju Liu**, Tucheng (TW)

(73) Assignee: **Everlight Electronics Co., Ltd.**,  
Tucheng, Taipei County (TW)

(\*\*) Term: **14 Years**

(21) Appl. No.: **29/340,209**

(22) Filed: **Jul. 15, 2009**

(30) **Foreign Application Priority Data**

Jan. 16, 2009	(TW)	.....	98300181
Jan. 16, 2009	(TW)	.....	98300182
Jan. 16, 2009	(TW)	.....	98300183
Jan. 16, 2009	(TW)	.....	98300184

(51) **LOC (9) Cl.** ..... **26-03**

(52) **U.S. Cl.** ..... **D26/80; D26/85**

(58) **Field of Classification Search** ..... **D26/72,**  
**D26/82-92; 362/147, 432**  
See application file for complete search history.

(56) **References Cited**

U.S. PATENT DOCUMENTS

D212,722 S \* 11/1968 Kahn ..... D10/114  
(Continued)

FOREIGN PATENT DOCUMENTS

JP D1233394 3/2005  
(Continued)

*Primary Examiner*—Clare E Heflin

(74) *Attorney, Agent, or Firm*—Patterson Thuent  
Christensen Pedersen, P.A.

(57) **CLAIM**

We claim the ornamental design for a lighting apparatus, as shown.

**DESCRIPTION**

FIG. 1 is a perspective view of the first embodiment showing the claimed design;

FIG. 2 is a front elevational view of FIG. 1;

FIG. 3 is a rear elevational view of FIG. 1;

FIG. 4 is a left side elevational view of FIG. 1;

FIG. 5 is a right side elevational view of FIG. 1;

FIG. 6 is a top plan view of FIG. 1;

FIG. 7 is a bottom plan view of FIG. 1;

FIG. 8 is a perspective view of the second embodiment showing the claimed design;

FIG. 9 is a front elevational view of FIG. 8;

FIG. 10 is a rear elevational view of FIG. 8;

FIG. 11 is a left side elevational view of FIG. 8; a right side elevational view being symmetric to the left side elevational view;

FIG. 12 is a top plan view of FIG. 8;

FIG. 13 is a bottom plan view of FIG. 8;

FIG. 14 is a perspective view of the third embodiment showing the claimed design;

FIG. 15 is a front elevational view of FIG. 14;

FIG. 16 is a rear elevational view of FIG. 14;

FIG. 17 is a left side elevational view of FIG. 14; a right side elevational view being symmetric to the left side elevational view;

FIG. 18 is a top plan view of FIG. 14;

FIG. 19 is a bottom plan view of FIG. 14;

FIG. 20 is a perspective view of the fourth embodiment showing the claimed design;

FIG. 21 is a front elevational view of FIG. 20;

FIG. 22 is a rear elevational view of FIG. 20;

FIG. 23 is a left side elevational view of FIG. 20; a right side elevational view being symmetric to the left side elevational view; and,

FIG. 24 is a top plan view of FIG. 20; a bottom plan view being symmetric to the top plan view.

**1 Claim, 20 Drawing Sheets**

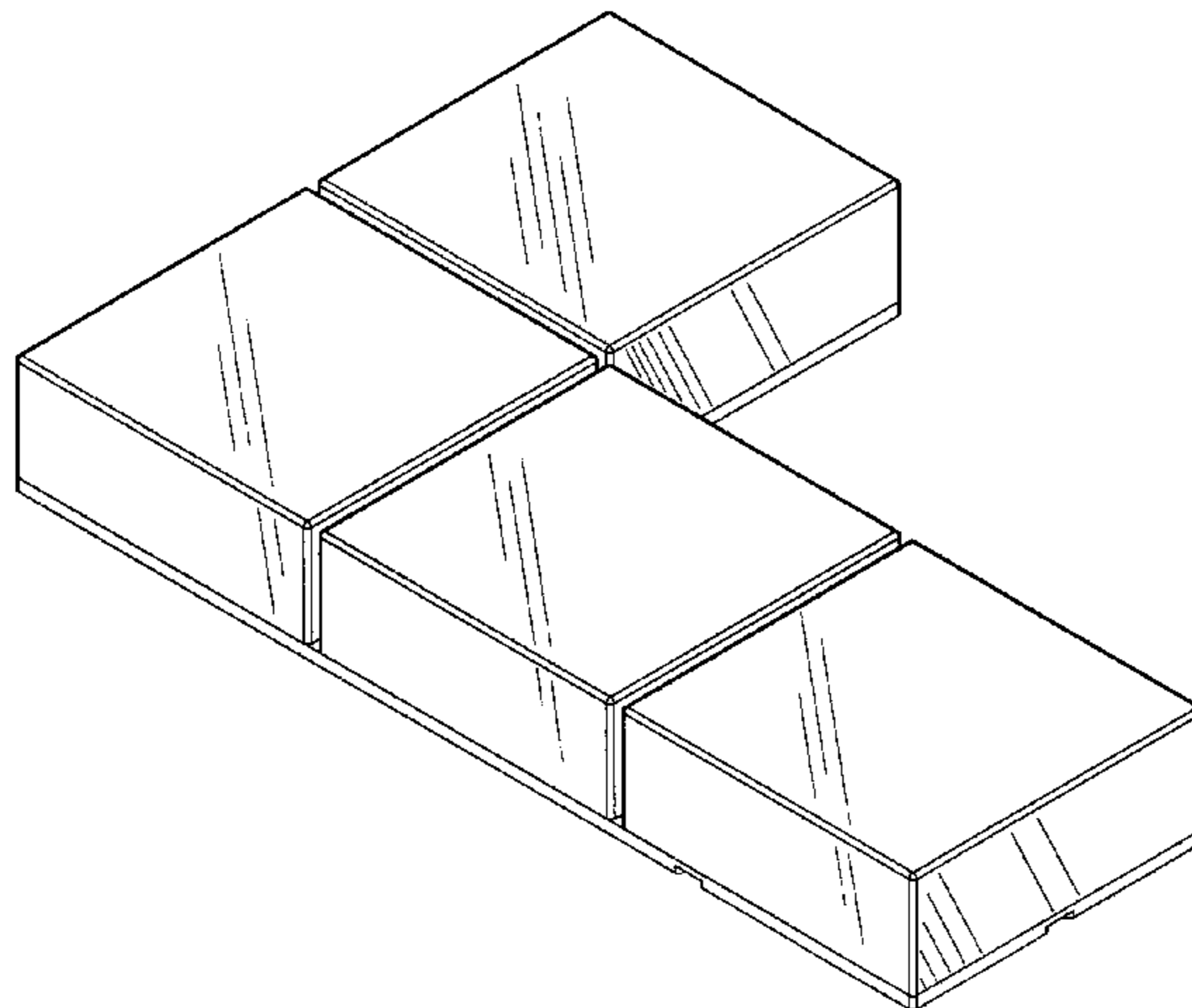

# US D625,877 S

Page 2

---

## U.S. PATENT DOCUMENTS

3,745,327 A \* 7/1973 Lowery et al. .... 362/227  
D411,326 S \* 6/1999 Roorda ..... D26/87  
D464,458 S \* 10/2002 Lee ..... D26/80  
D480,494 S \* 10/2003 Targetti ..... D26/72  
D509,313 S \* 9/2005 Friedman et al. .... D26/71  
D564,695 S \* 3/2008 Krause ..... D26/86  
D566,877 S \* 4/2008 Chandler ..... D26/85  
D574,090 S 7/2008 Takada et al.  
7,434,950 B2 \* 10/2008 Whitney ..... 362/92

D590,088 S \* 4/2009 Dworschak ..... D26/85

## FOREIGN PATENT DOCUMENTS

JP D1233838 3/2005  
JP D1315826 11/2007  
JP D1331506 6/2008  
TW M273579 2/1994  
TW D126341 2/1996  
TW D126714 1/1997

\* cited by examiner

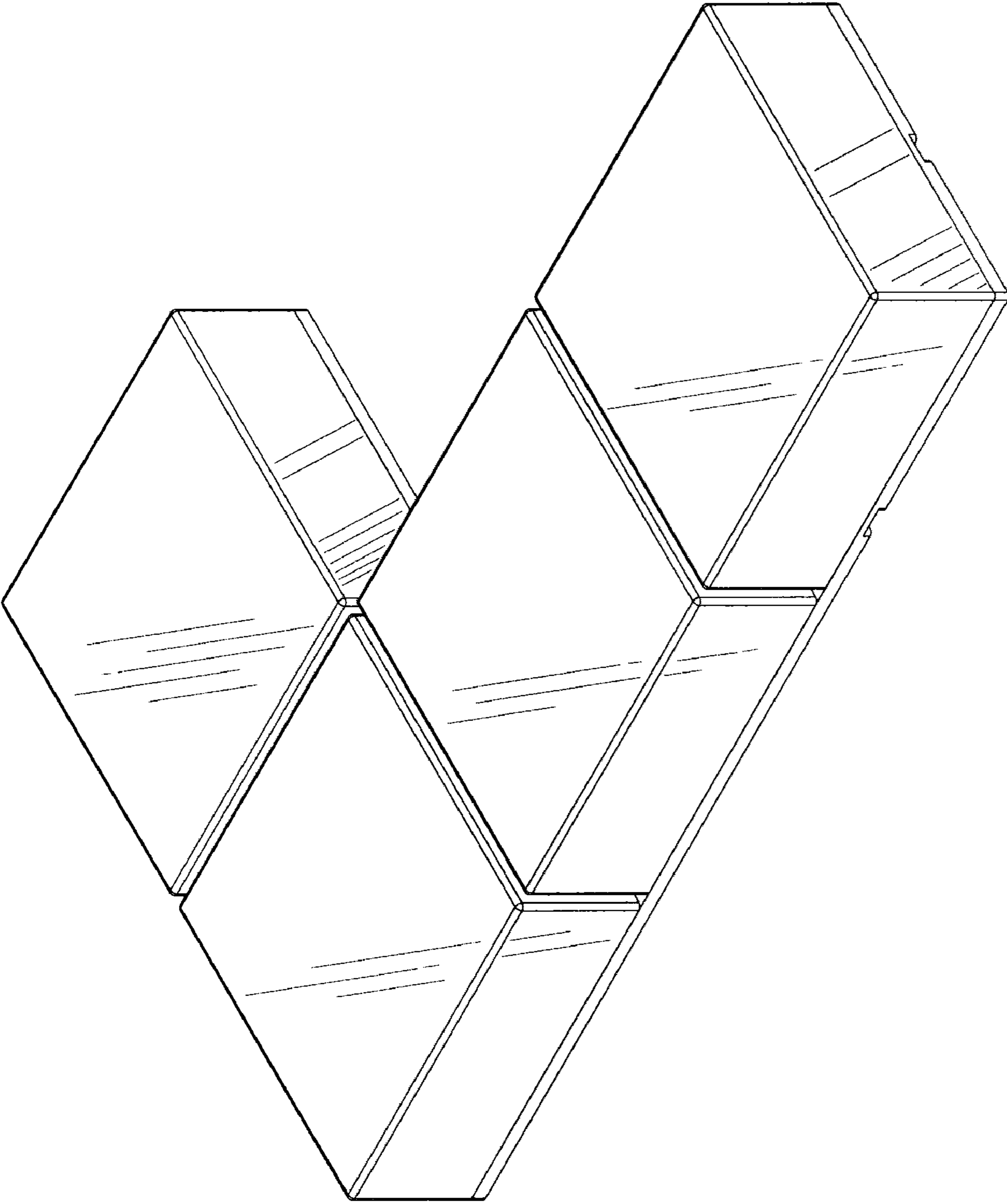

FIG.1

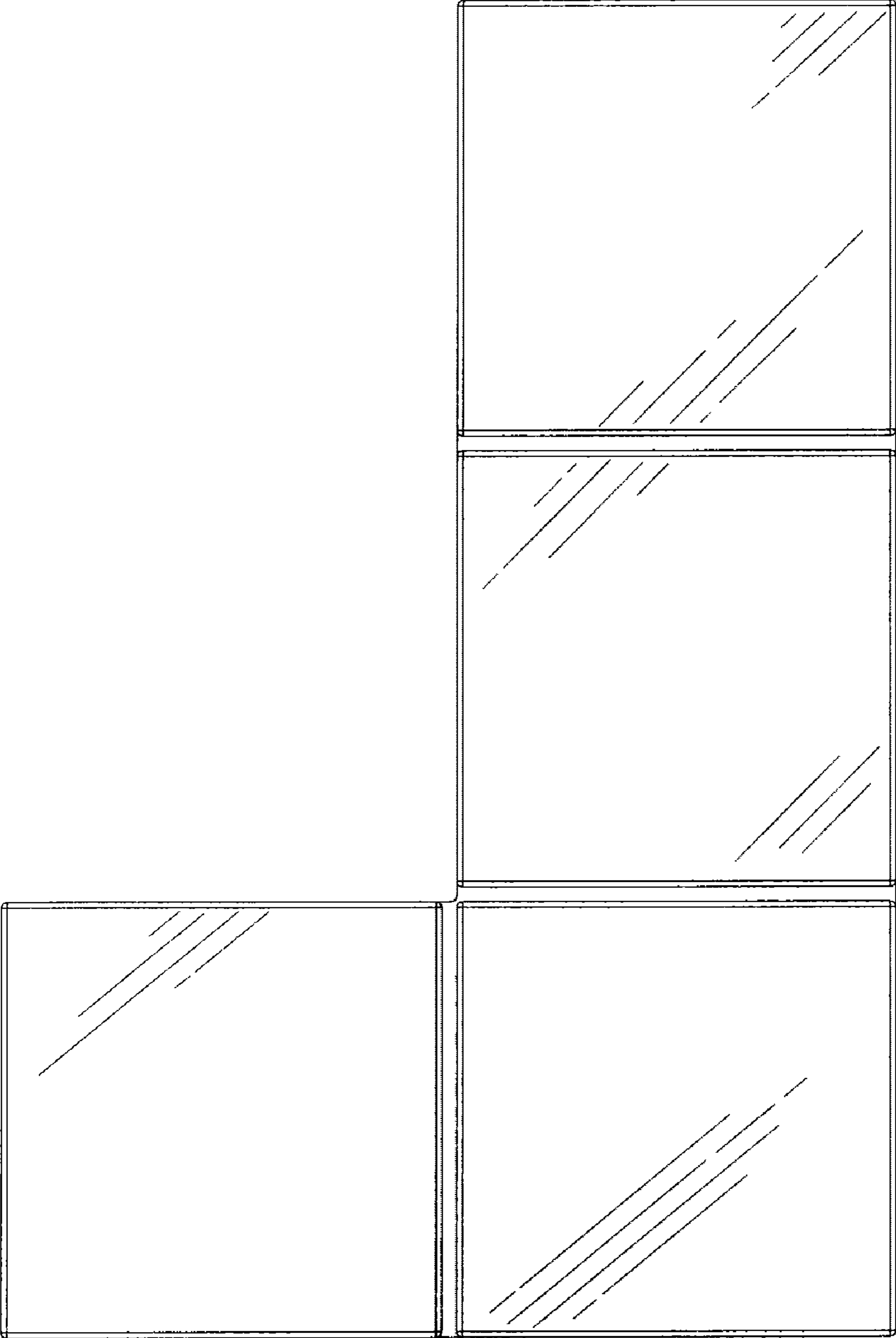

FIG.2

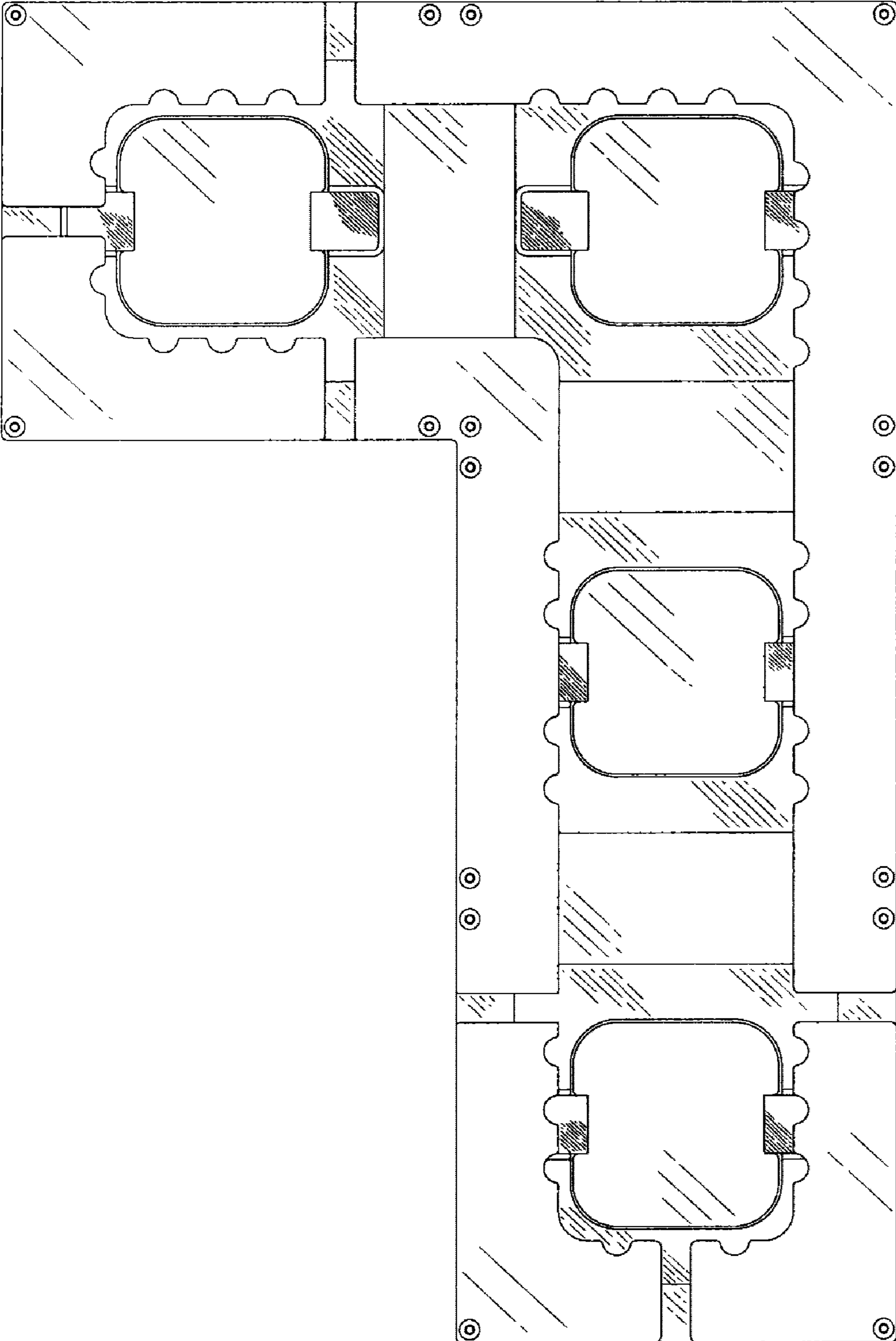

FIG.3

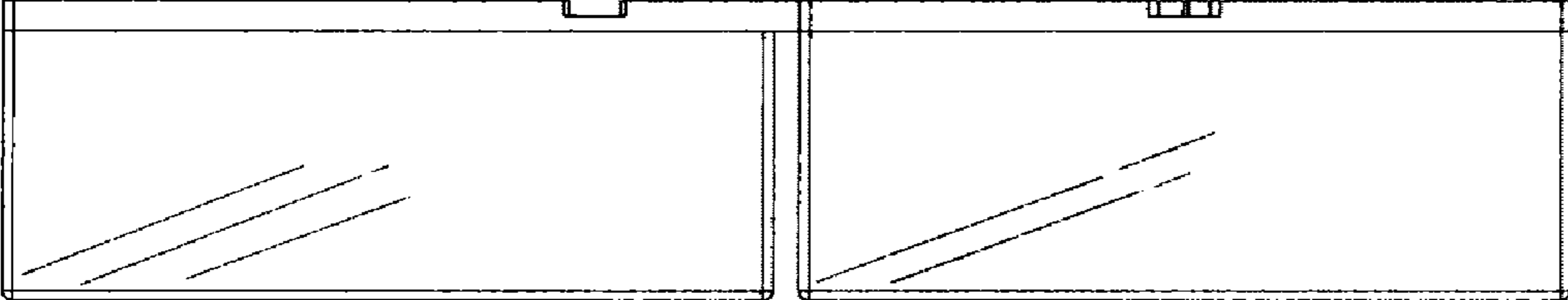

FIG.5

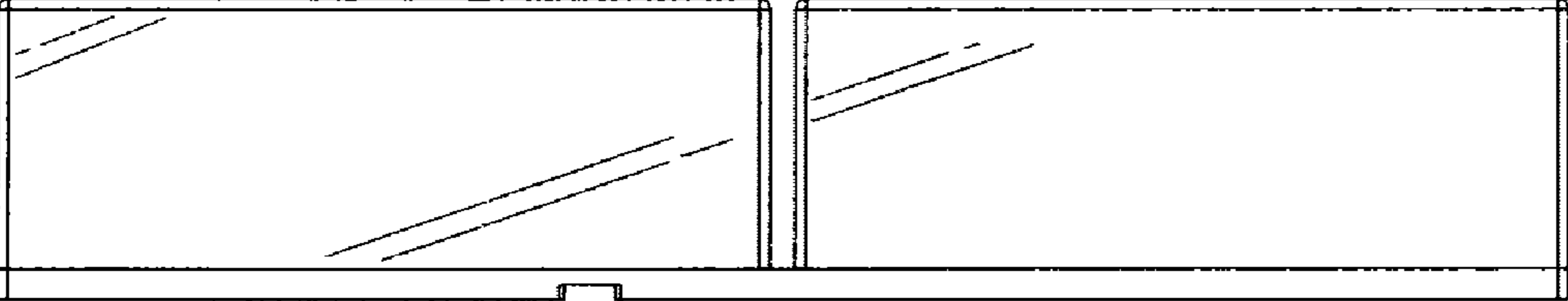

FIG.4

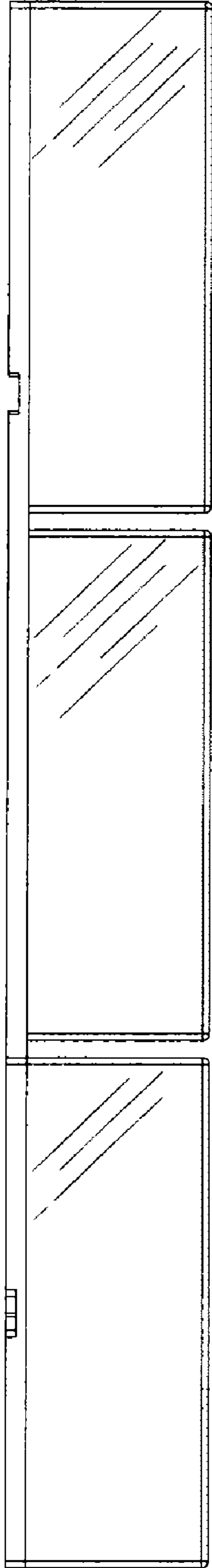

FIG. 6

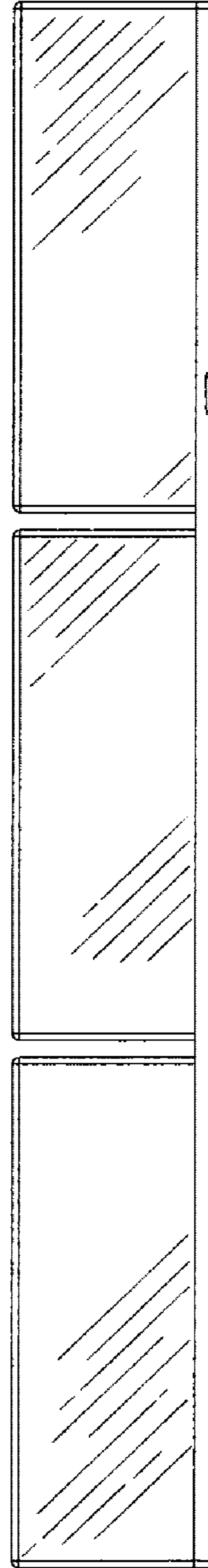

FIG. 7

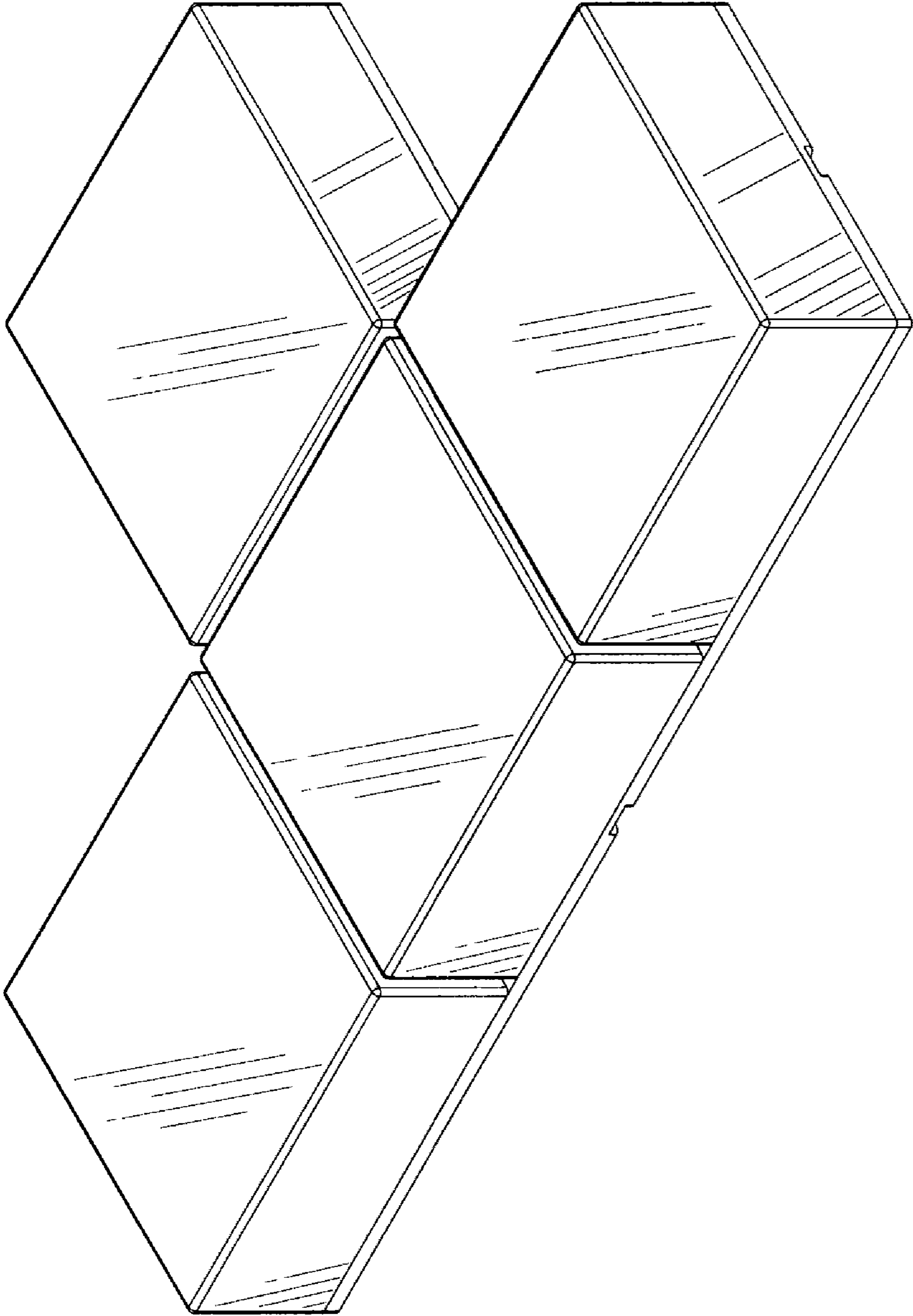

FIG. 8



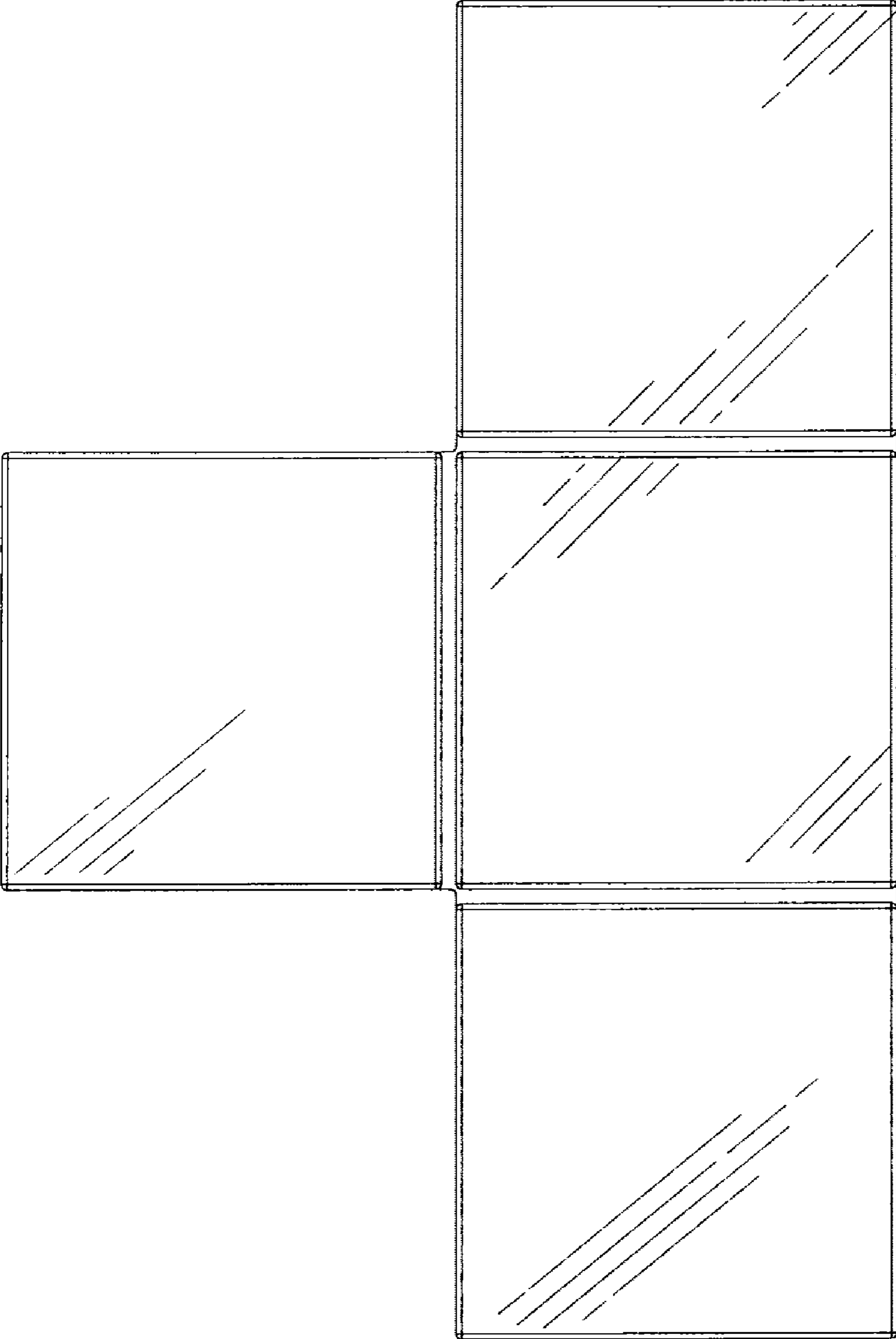

FIG.9

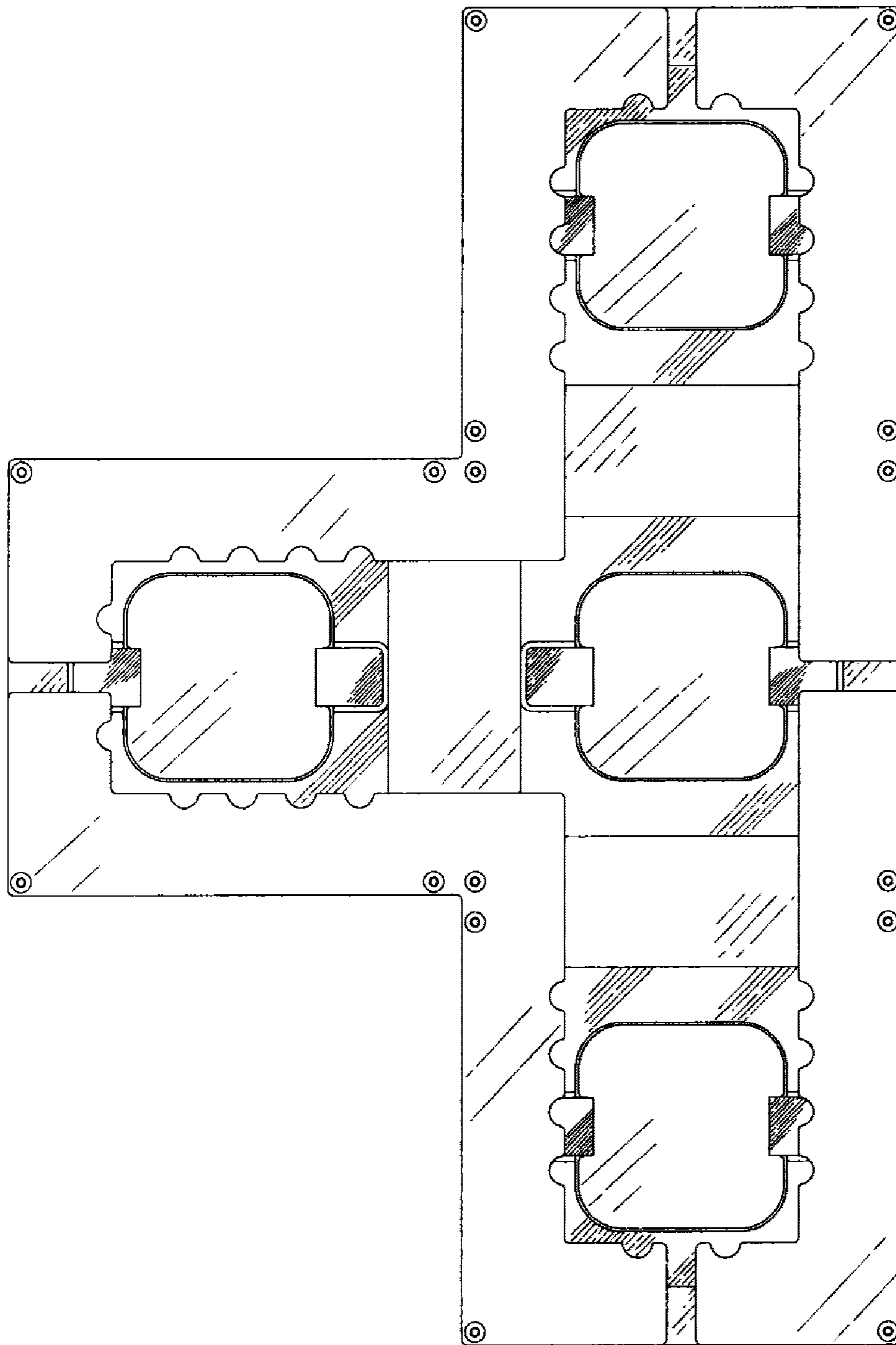

FIG.10

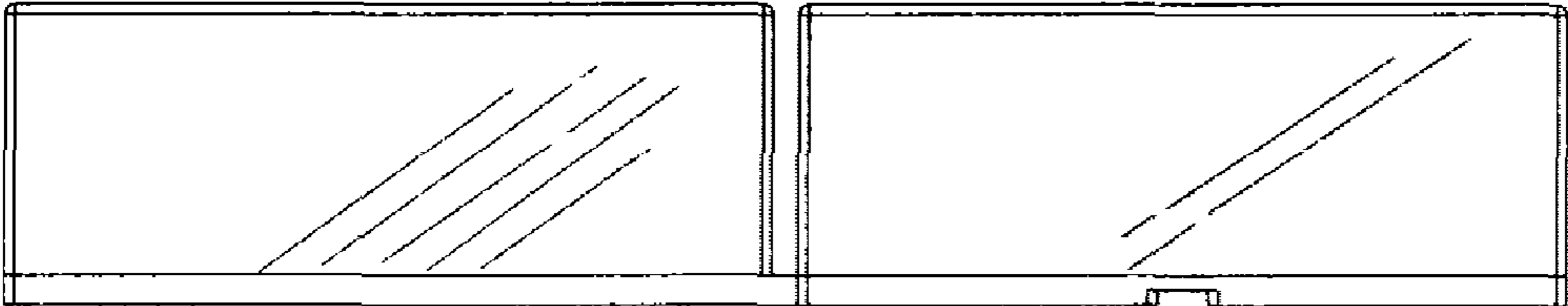

FIG.11

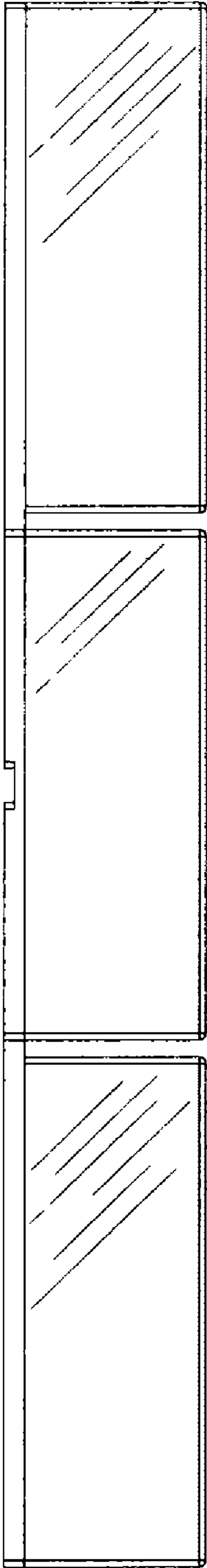

FIG. 12

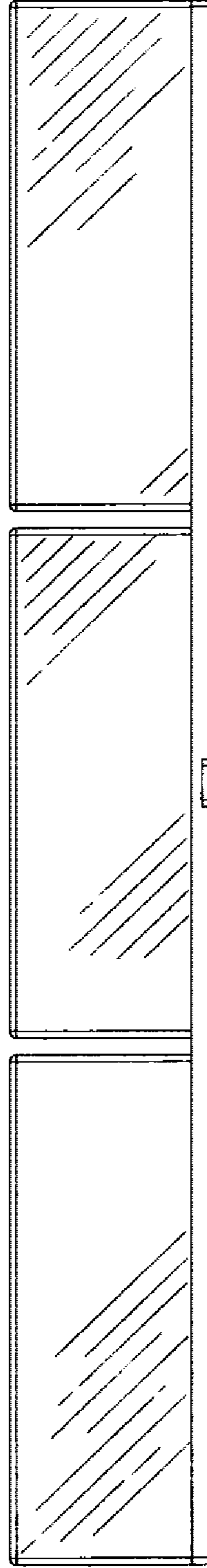

FIG. 13

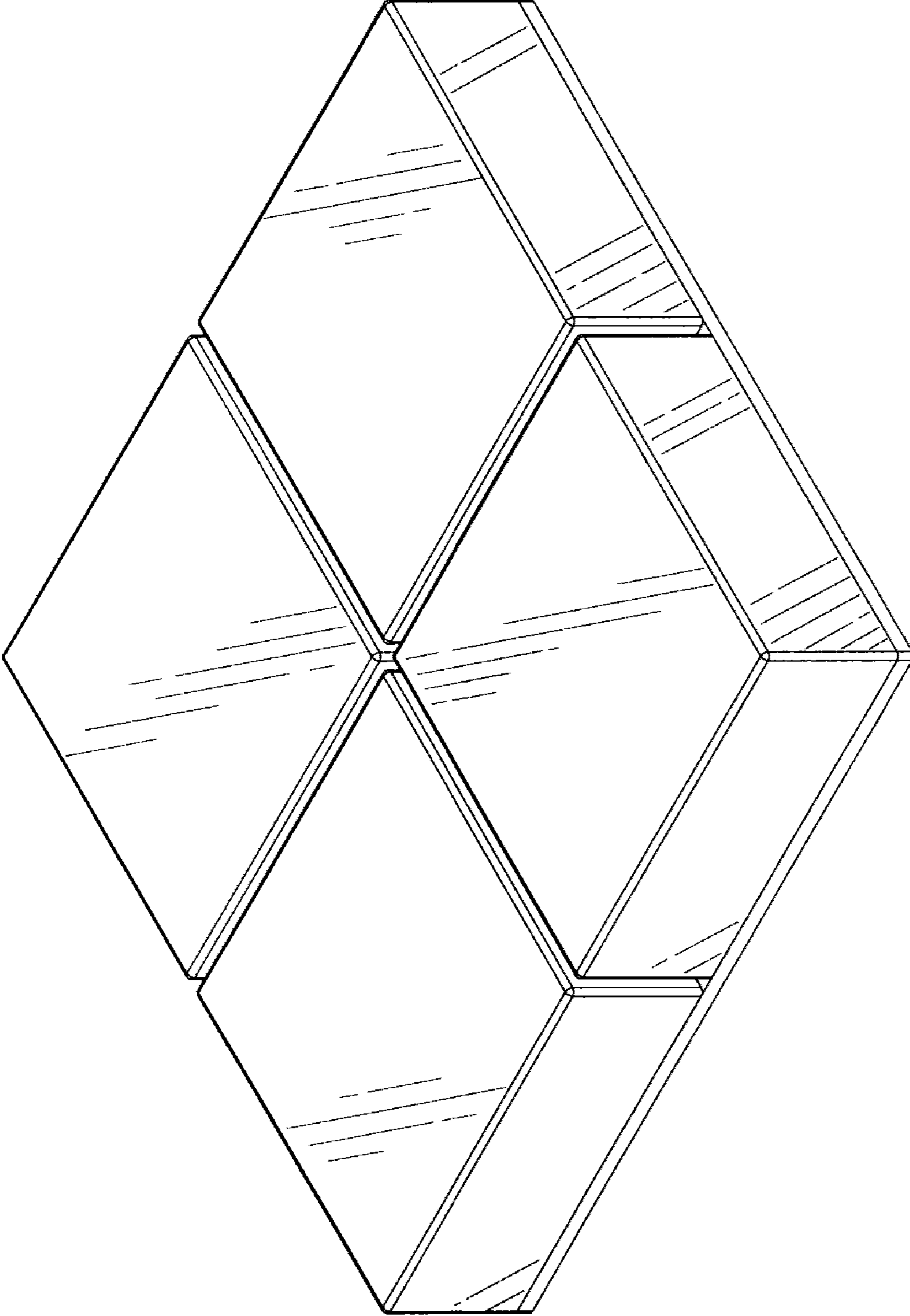

FIG.14

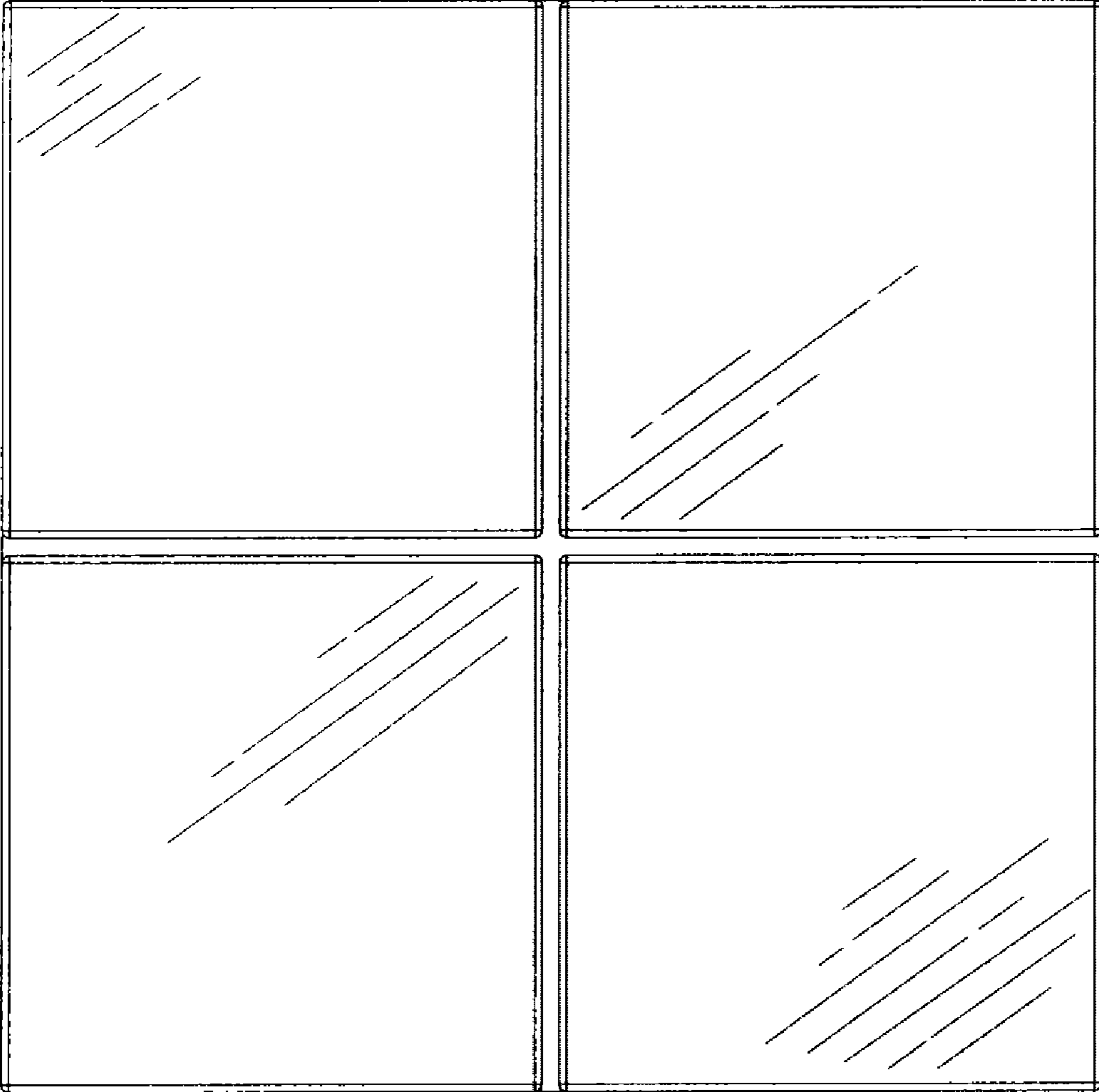

FIG.15

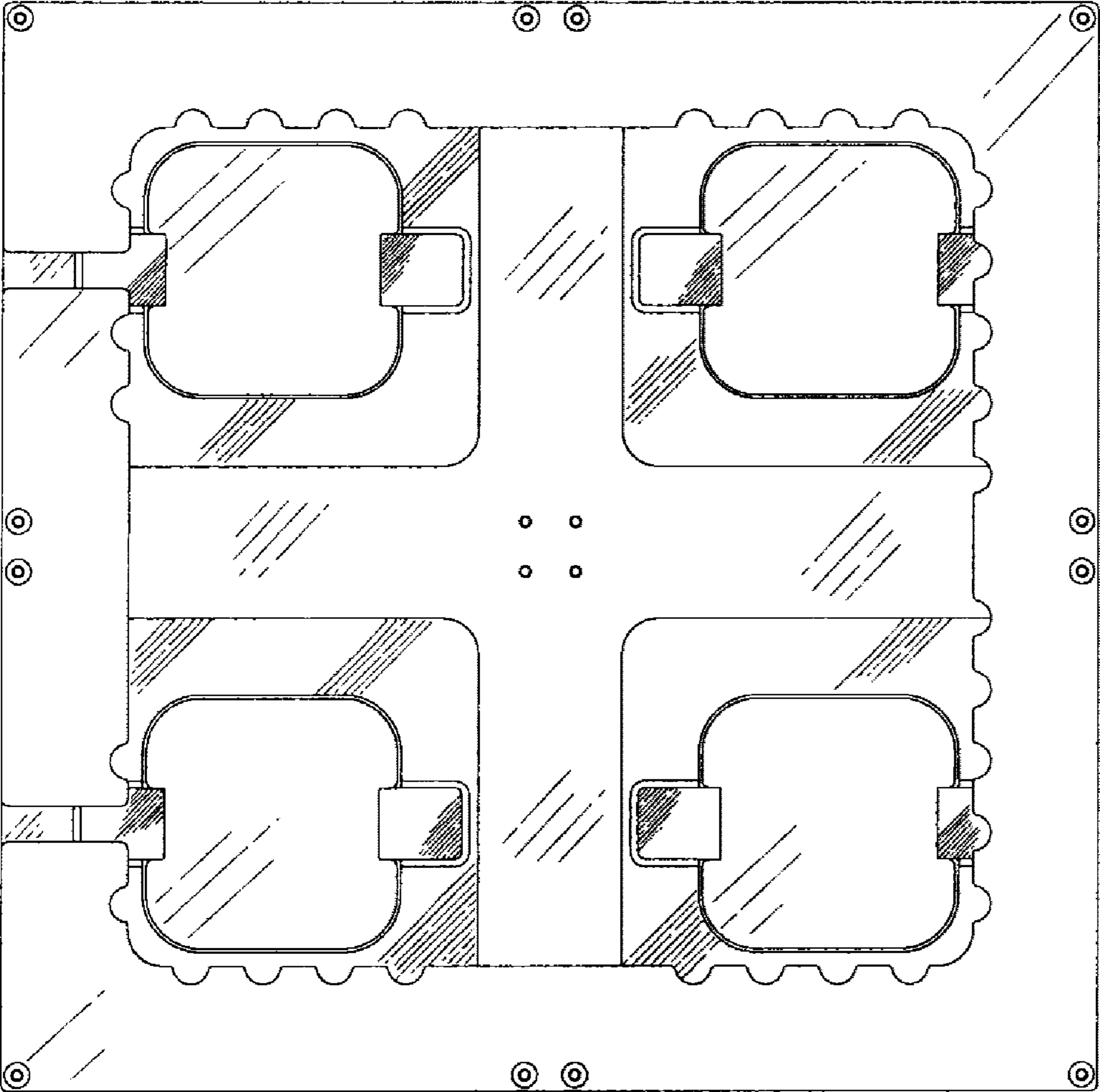

FIG.16

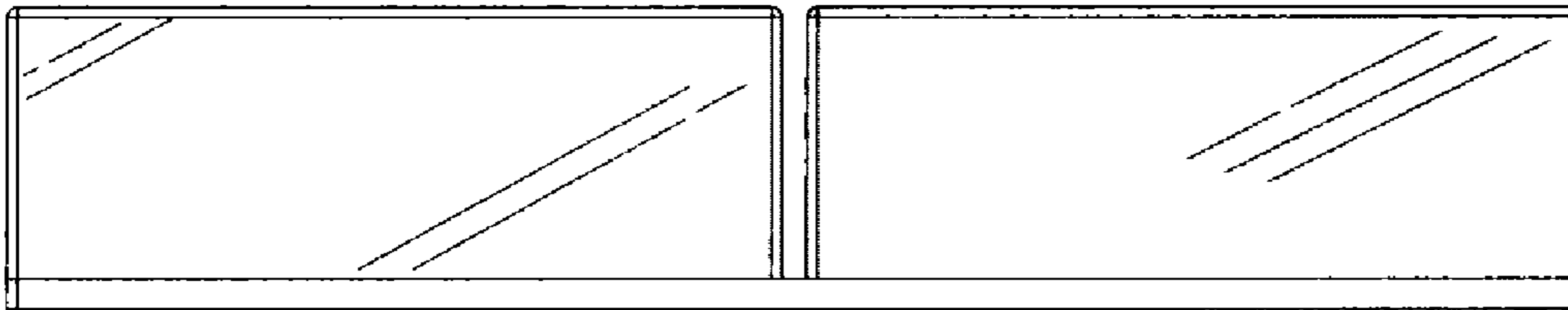

FIG.17



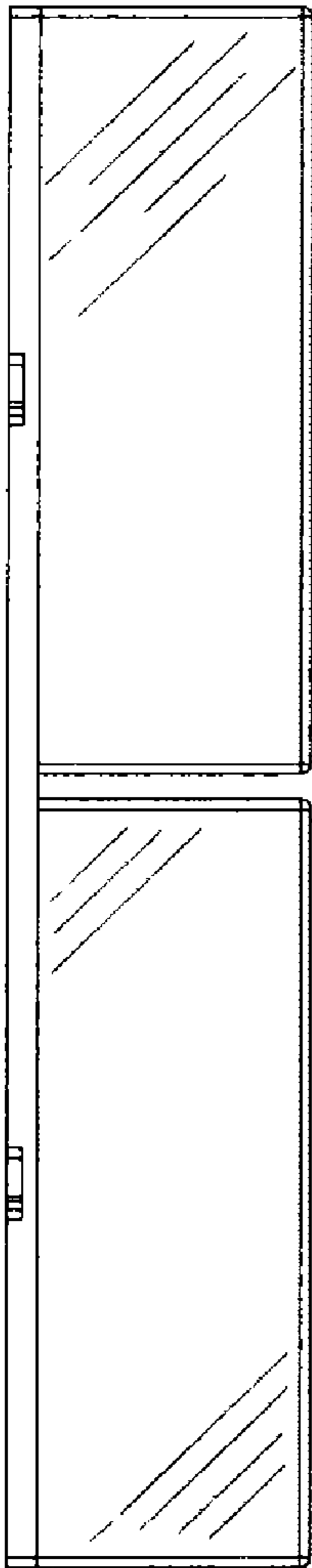

FIG. 18

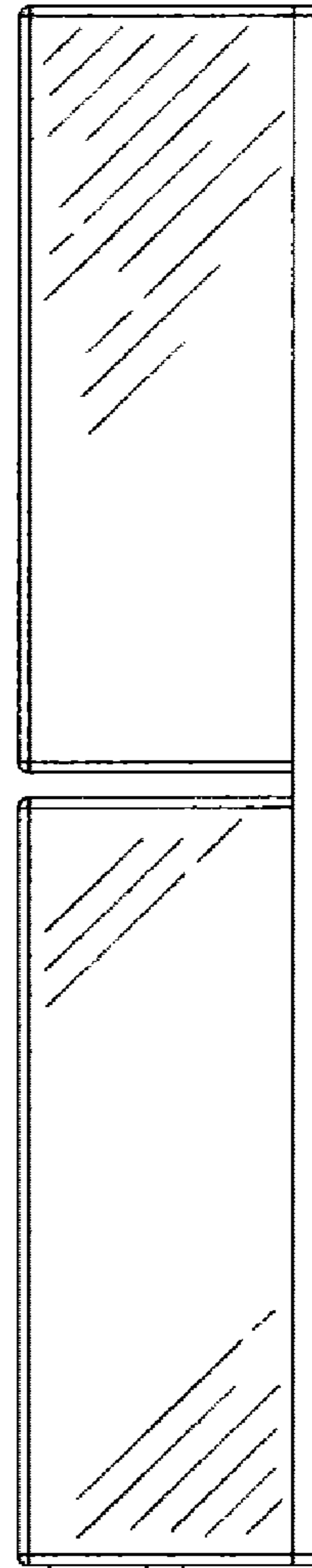

FIG. 19

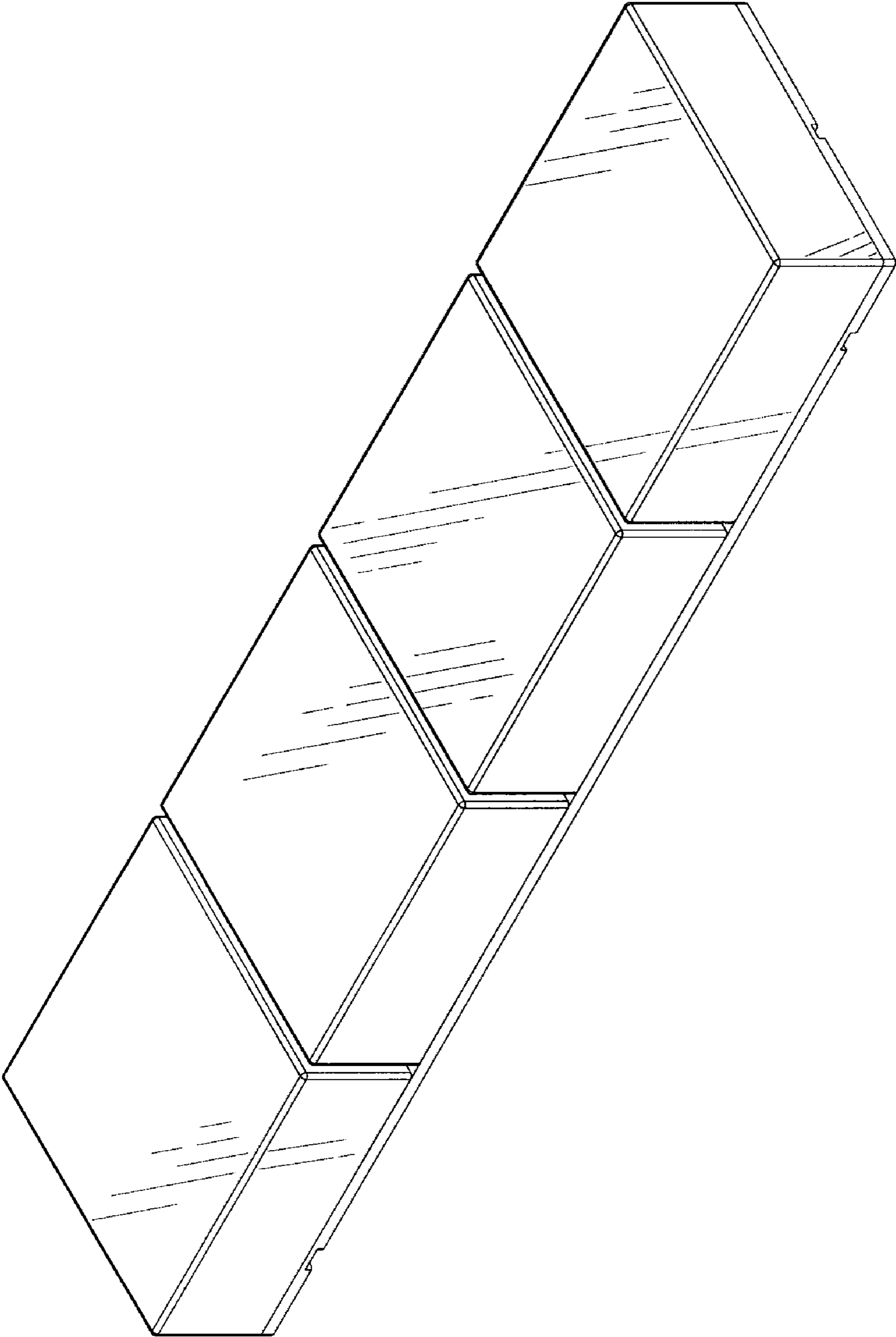

FIG.20

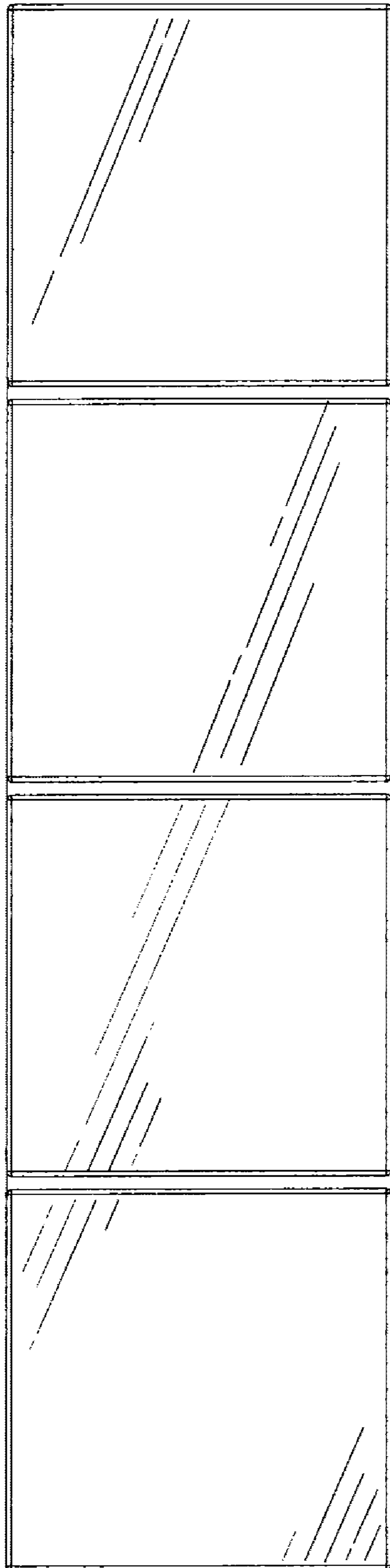

FIG. 21

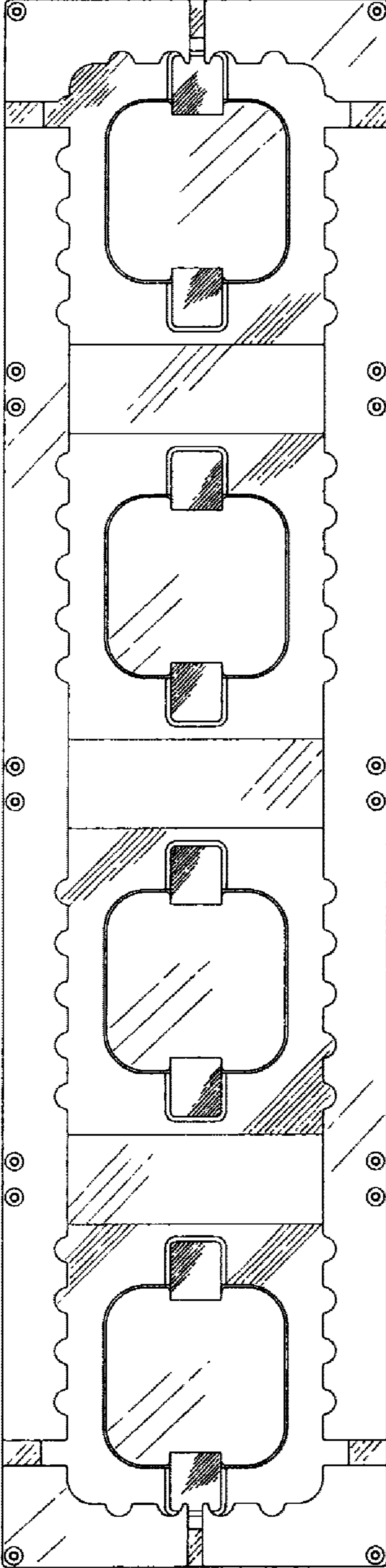

FIG.22

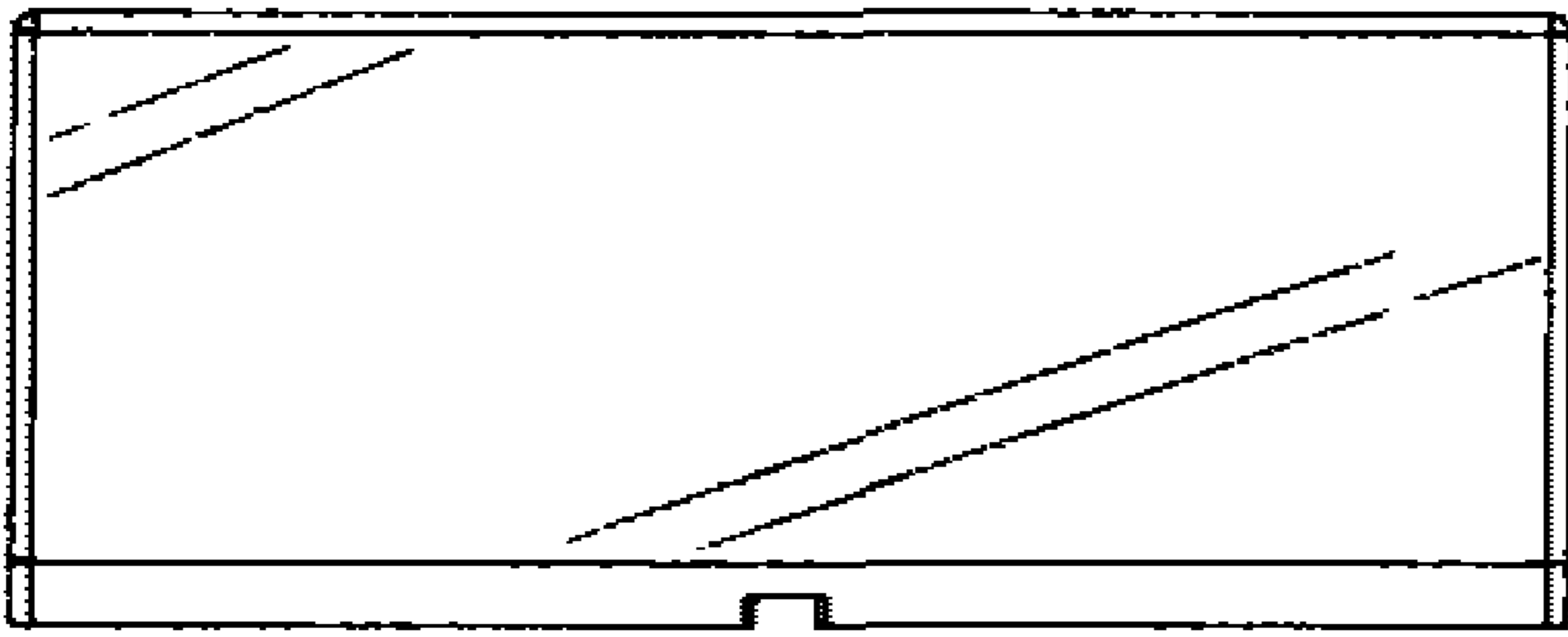

FIG. 23

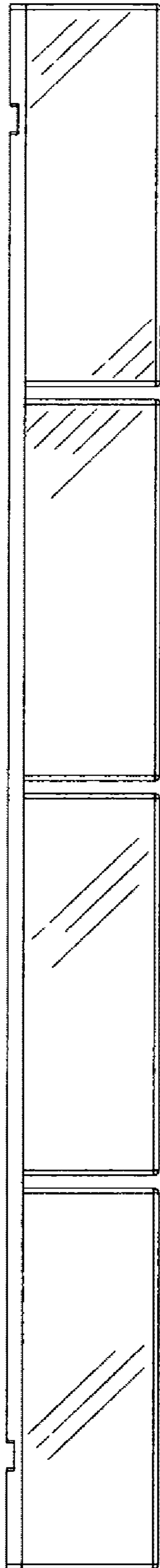

FIG. 24