



US00D625863S

(12) **United States Design Patent**
Kingston et al.

(10) **Patent No.:** **US D625,863 S**
(45) **Date of Patent:** **** Oct. 19, 2010**

(54) **FLASHLIGHT**

(75) Inventors: **Ronald J. Kingston**, Syracuse, NY (US); **Donwoong Kang**, Camillus, NY (US); **Scott W. Osiecki**, Skaneateles, NY (US)

(73) Assignee: **Eveready Battery Company, Inc.**, St. Louis, MO (US)

(**) Term: **14 Years**

(21) Appl. No.: **29/355,488**

(22) Filed: **Feb. 9, 2010**

(51) **LOC (9) Cl.** **26-02**

(52) **U.S. Cl.** **D26/39**

(58) **Field of Classification Search** D26/37, D26/38, 39, 40, 46, 49, 51; 362/157, 158, 362/183, 184, 190, 191, 192, 193, 194, 195, 362/196, 197, 198–208

See application file for complete search history.

(56) **References Cited**

U.S. PATENT DOCUMENTS

D472,998 S *	4/2003	Paris et al.	D26/39
D506,846 S *	6/2005	Kang et al.	D26/39
D533,954 S *	12/2006	Opolka	D26/39
D552,278 S *	10/2007	Spartano et al.	D26/39
D560,836 S *	1/2008	Garrity et al.	D26/39
D592,782 S *	5/2009	Hine et al.	D26/39
D603,539 S *	11/2009	Shiu	D26/39

* cited by examiner

Primary Examiner—Charles A Rademaker

Assistant Examiner—Carissa C Fitts

(74) *Attorney, Agent, or Firm*—Gregory J. Adams

(57) **CLAIM**

We claim the ornamental design for a flashlight, as shown and described.

DESCRIPTION

FIG. 1 is a front perspective view of a flashlight showing our new design;

FIG. 2 is a rear perspective view thereof;

FIG. 3 is a front view thereof;

FIG. 4 is a rear view thereof;

FIG. 5 is a left side view thereof;

FIG. 6 is a right side view thereof;

FIG. 7 is a top view thereof;

FIG. 8 is a bottom view thereof;

FIG. 9 is a front perspective view of the headlight component of the flashlight with the band and taillight removed for ease of illustration;

FIG. 10 is a rear perspective view thereof;

FIG. 11 is a front view thereof;

FIG. 12 is a rear view thereof;

FIG. 13 is a left side view thereof, the right side view being a mirror image thereof;

FIG. 14 is a bottom view thereof;

FIG. 15 is a top view thereof;

FIG. 16 is a front perspective view of the taillight component of the flashlight with the band and headlight removed for ease of illustration;

FIG. 17 is a rear perspective view thereof;

FIG. 18 is a front view thereof;

FIG. 19 is a rear view thereof;

FIG. 20 is a right side view thereof;

FIG. 21 is a top view thereof; and,

FIG. 22 is a bottom view thereof.

The broken lines shown in the drawings are for illustrative structure and form no part of the claimed design.

1 Claim, 12 Drawing Sheets

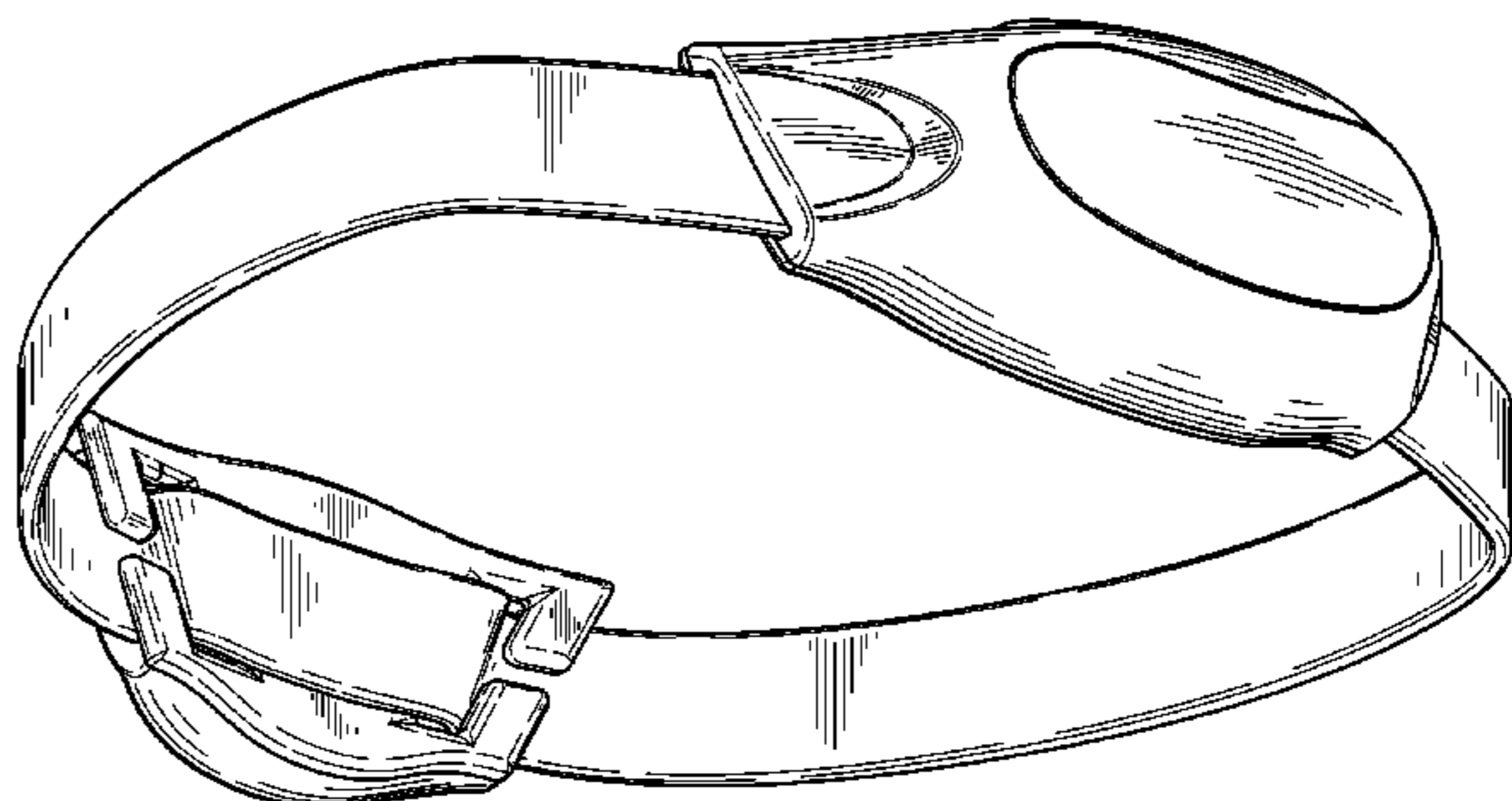
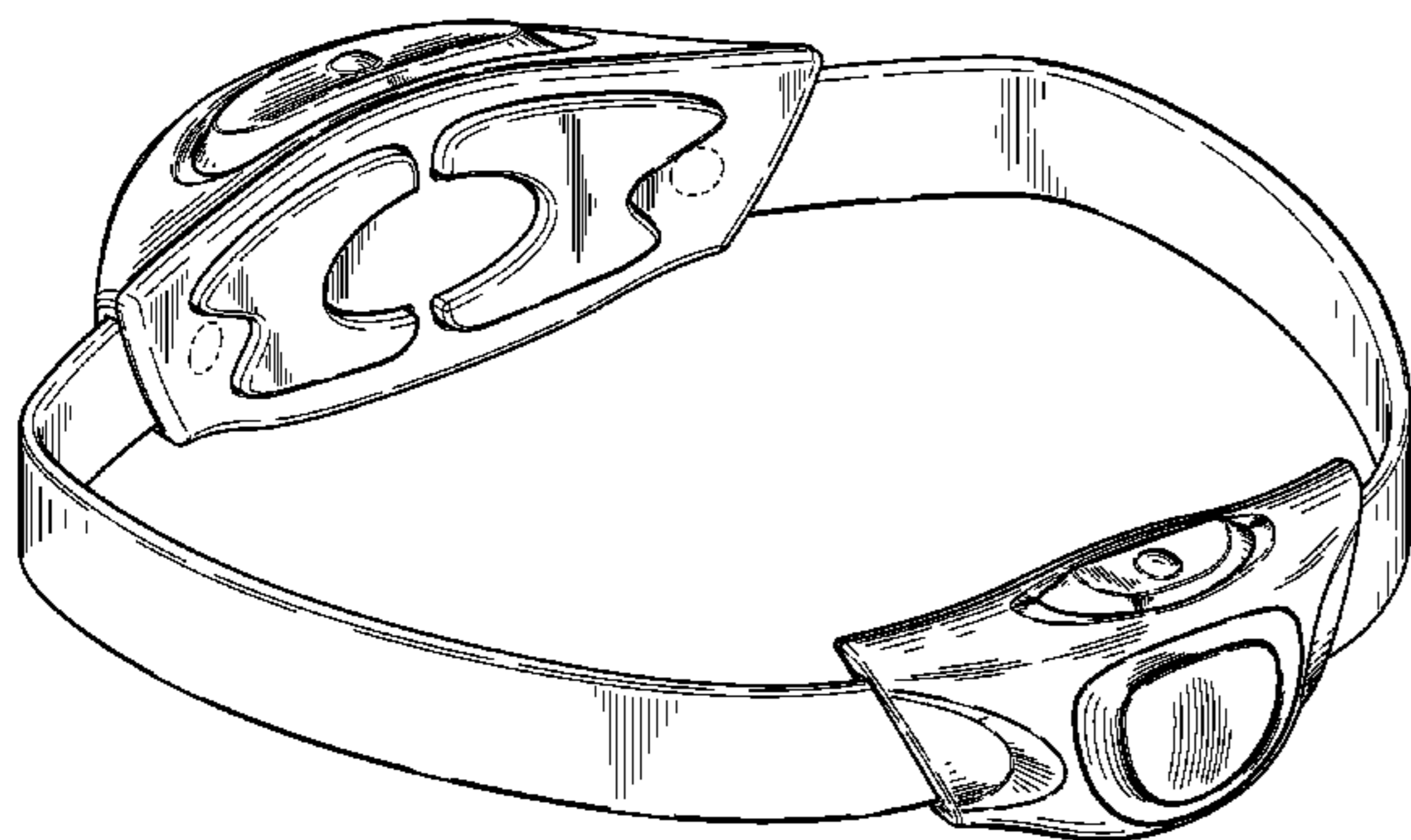

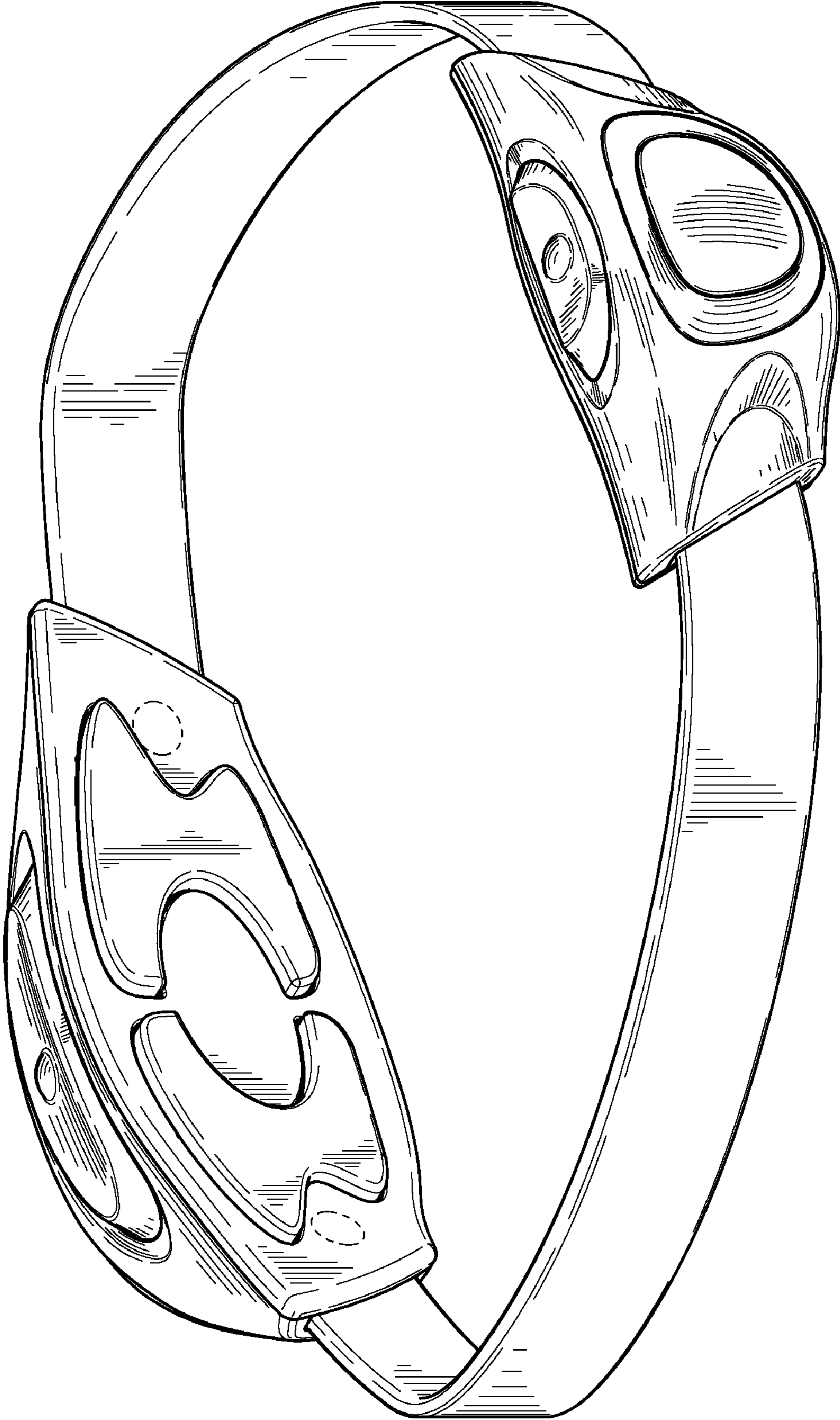

Fig. 1

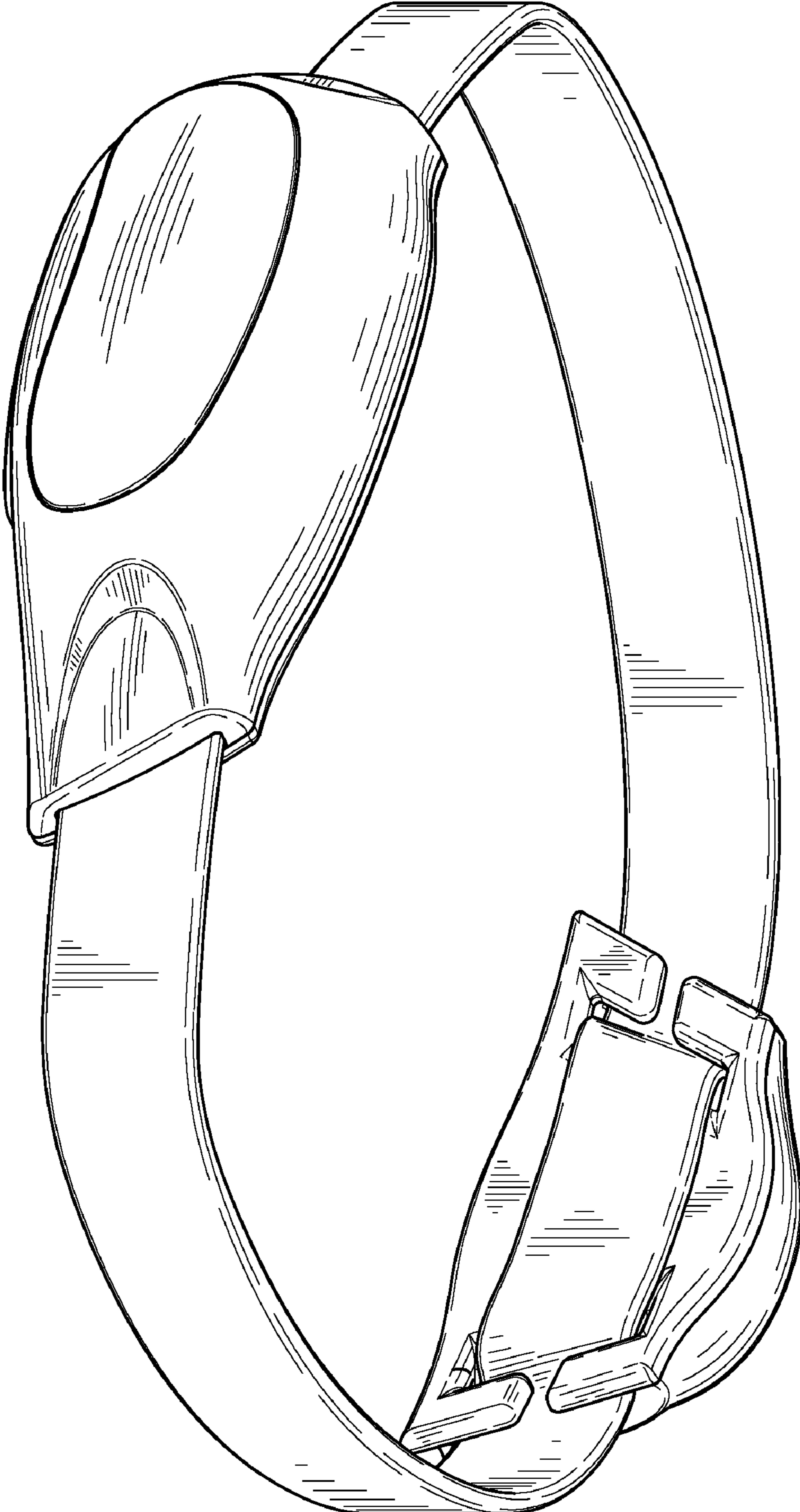

Fig. 2

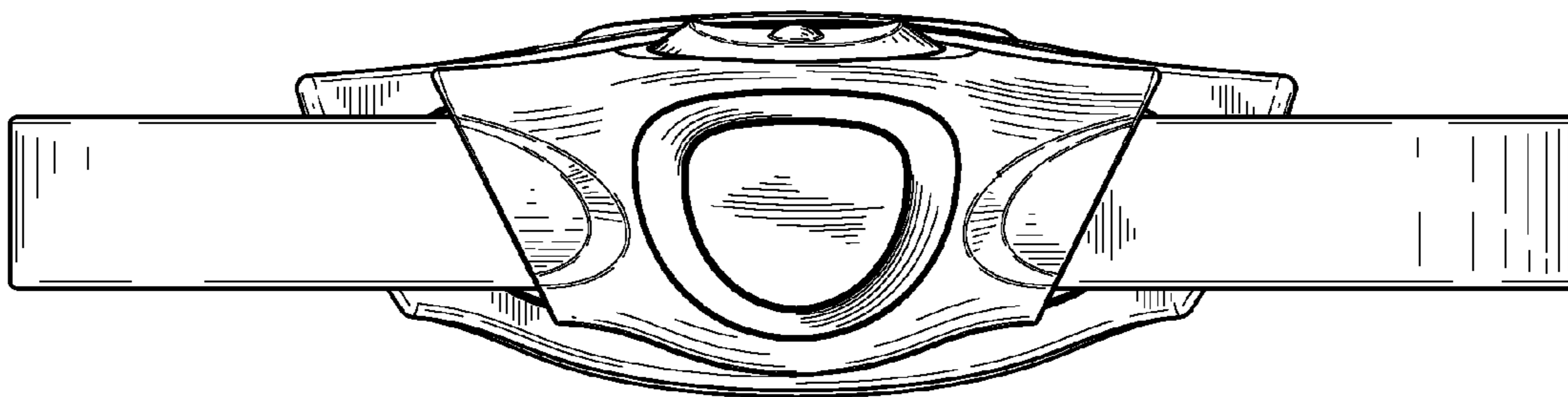

Fig. 3

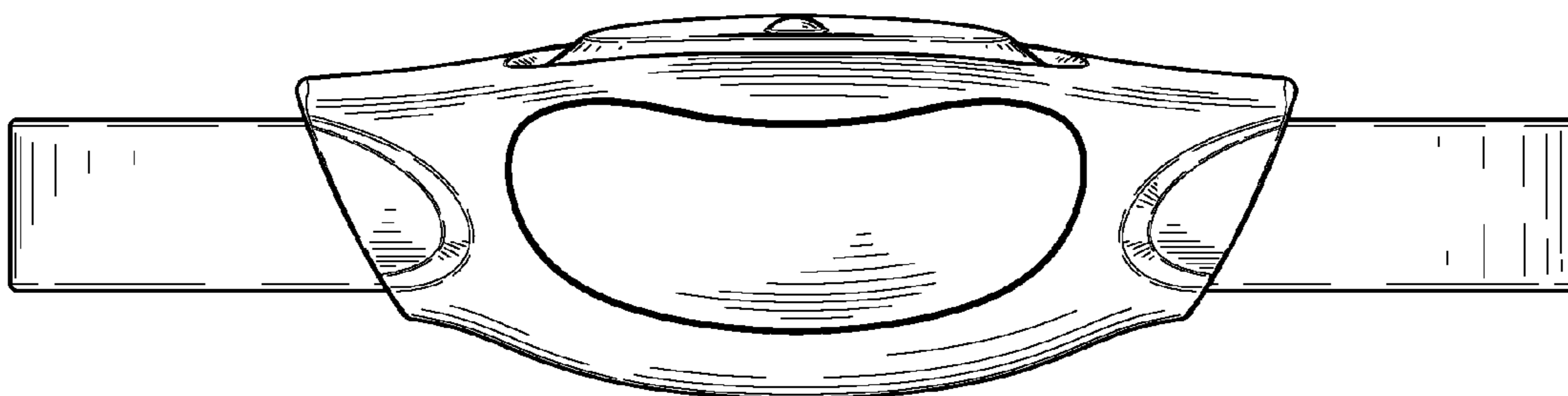

Fig. 4

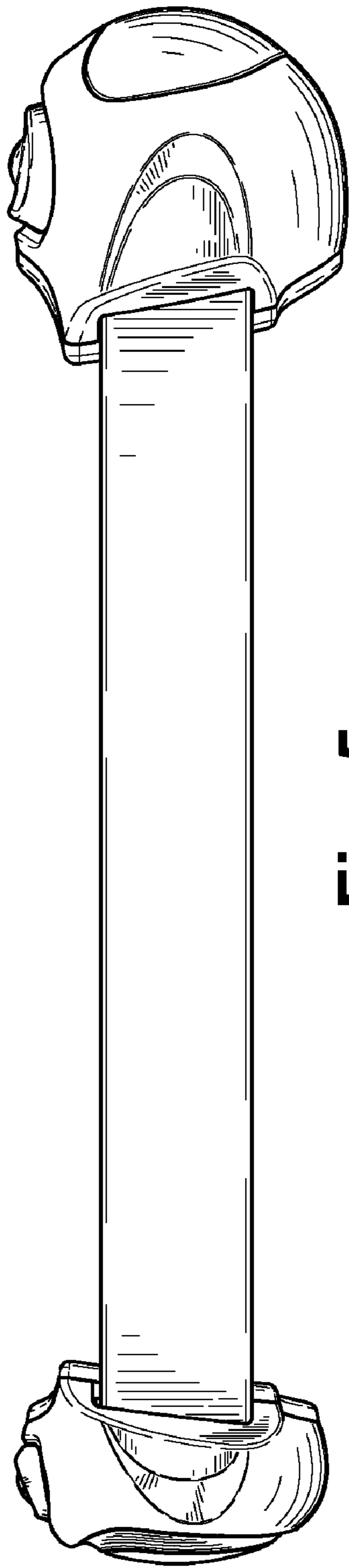

Fig. 5

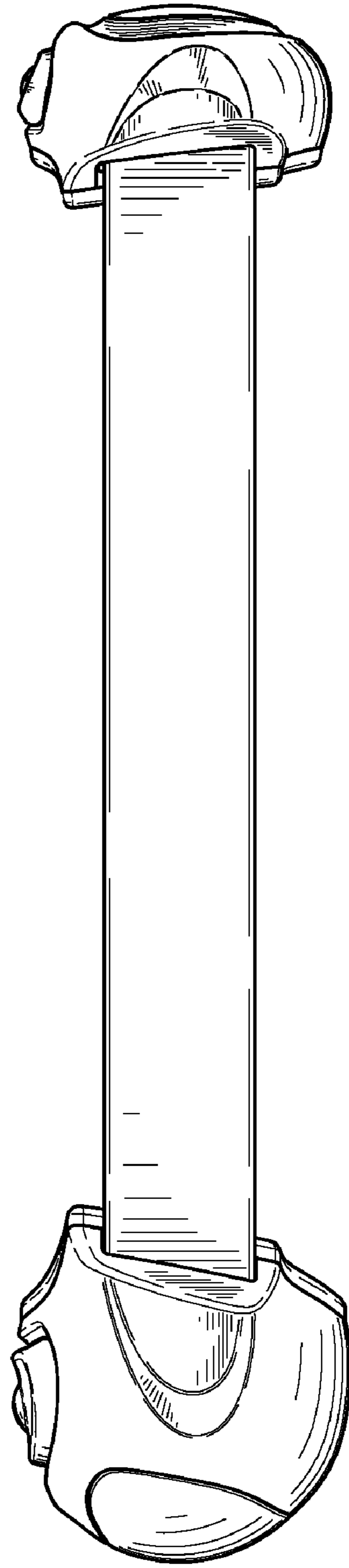

Fig. 6

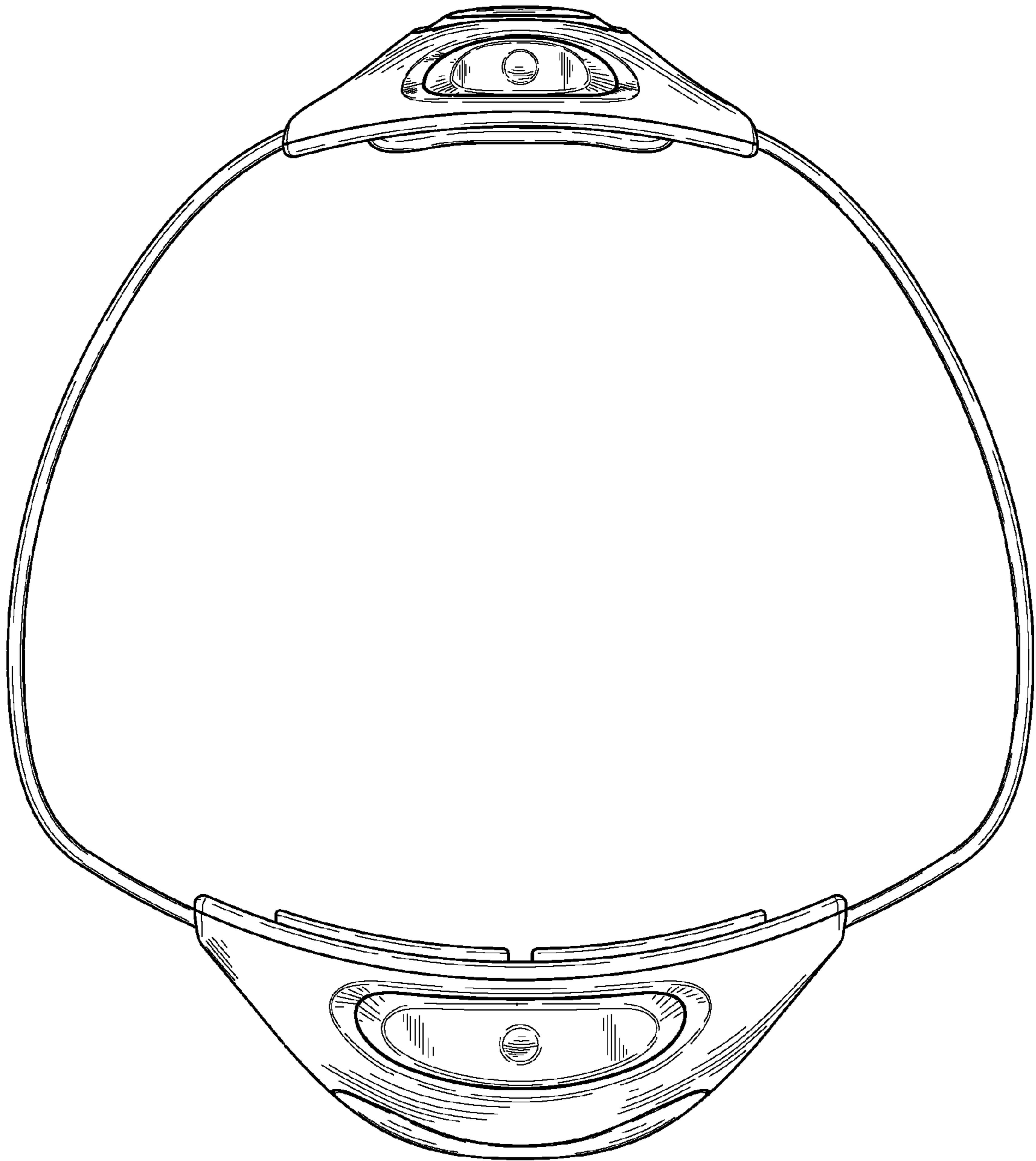

Fig. 7

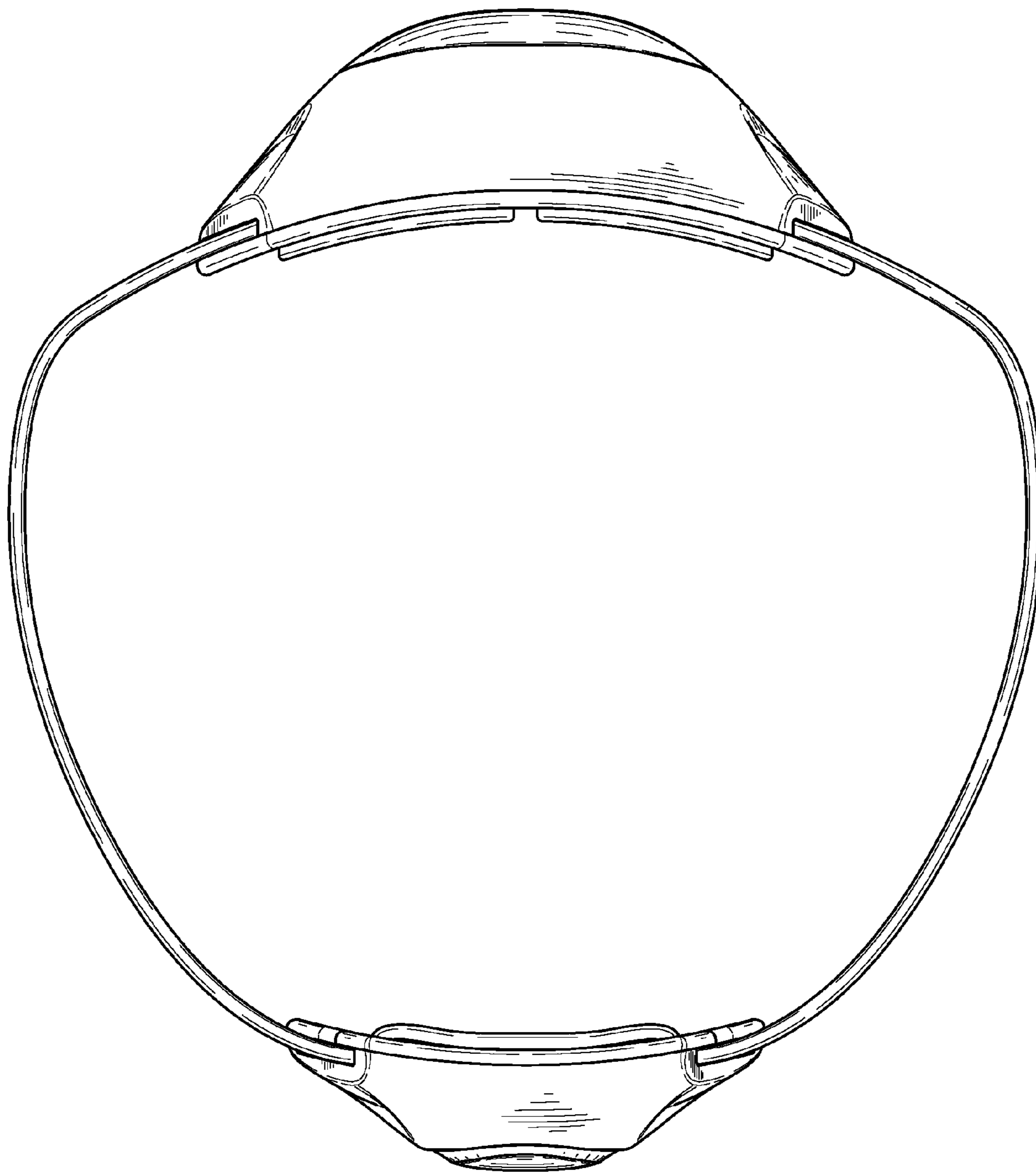

Fig. 8

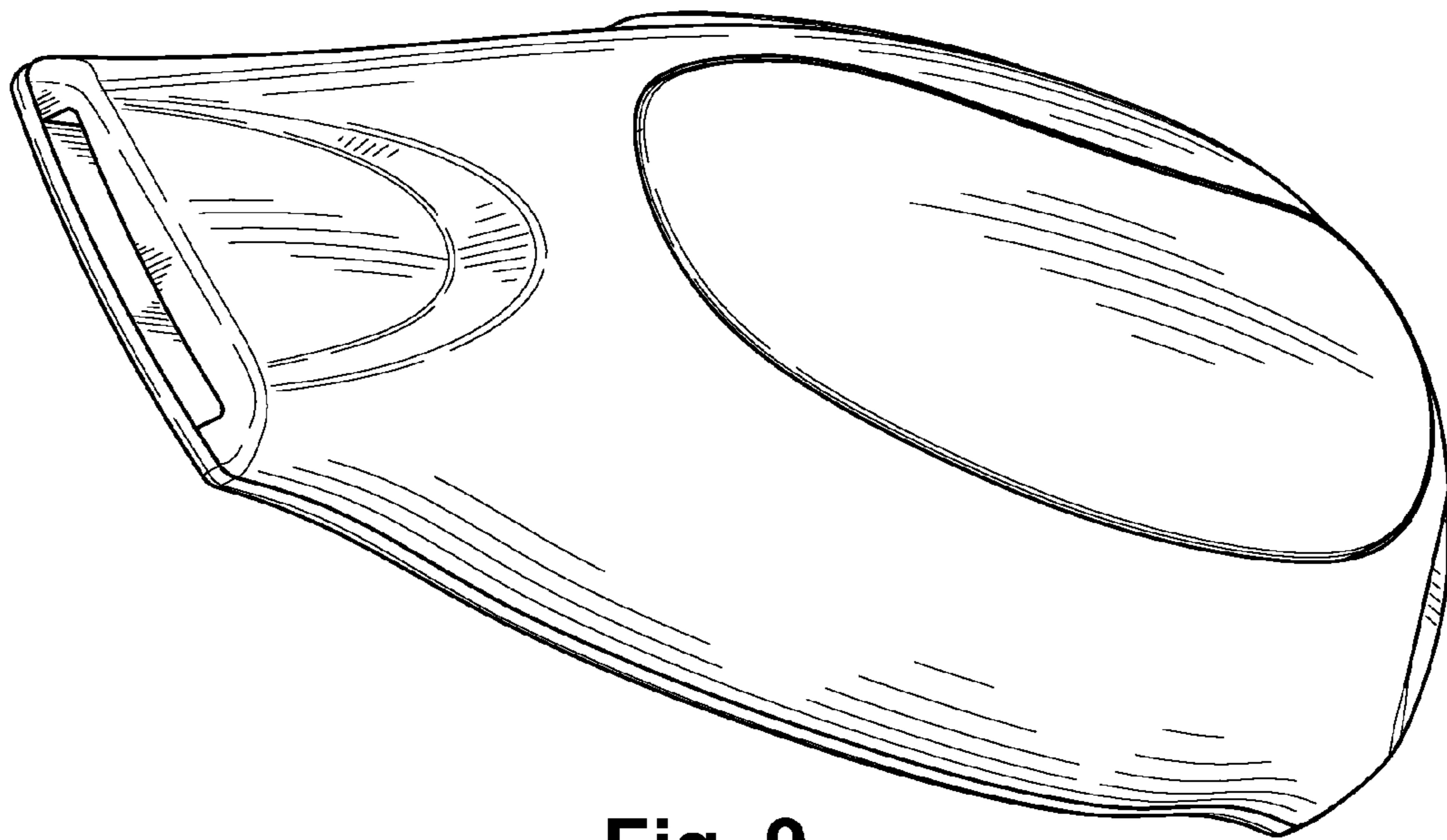

Fig. 9

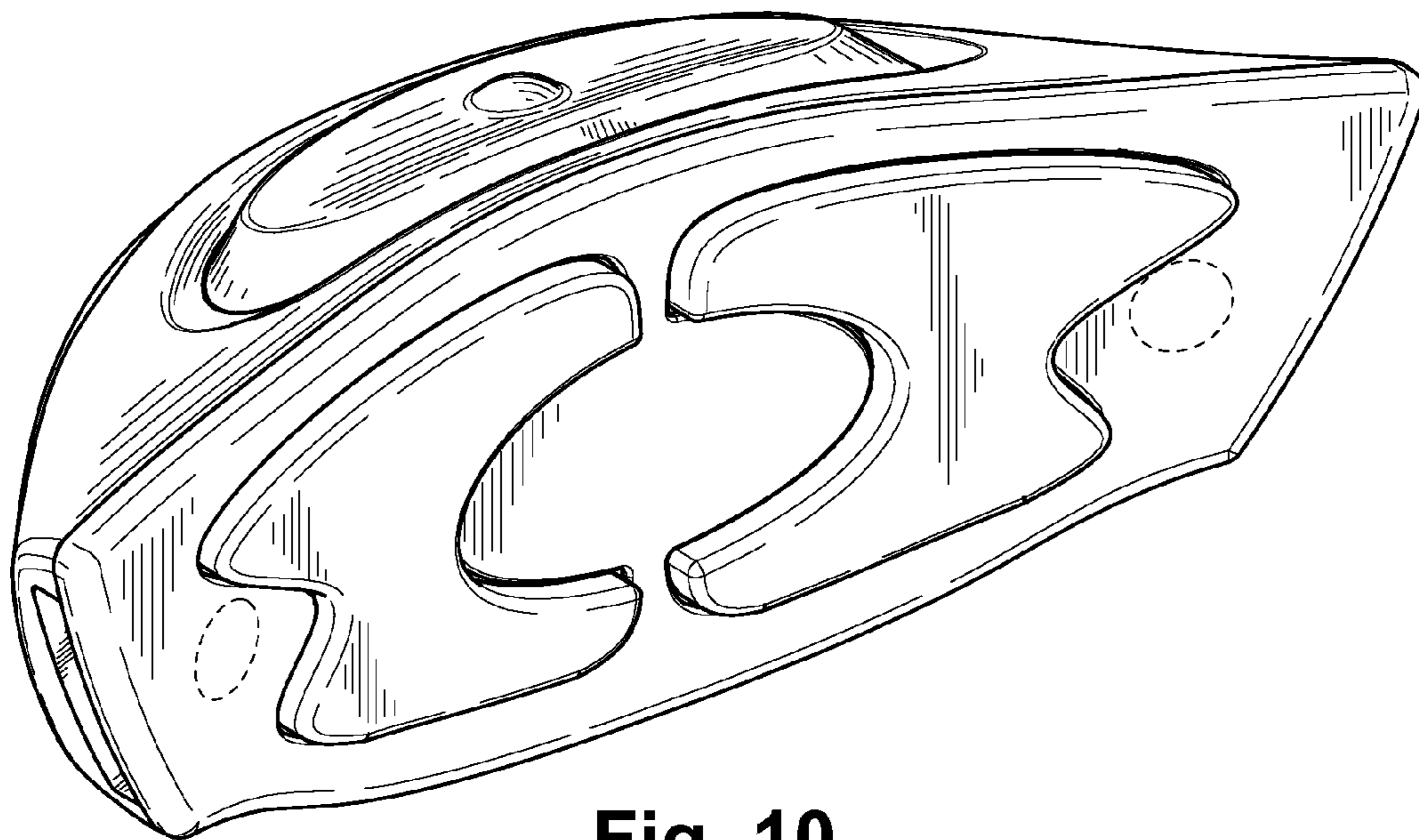

Fig. 10

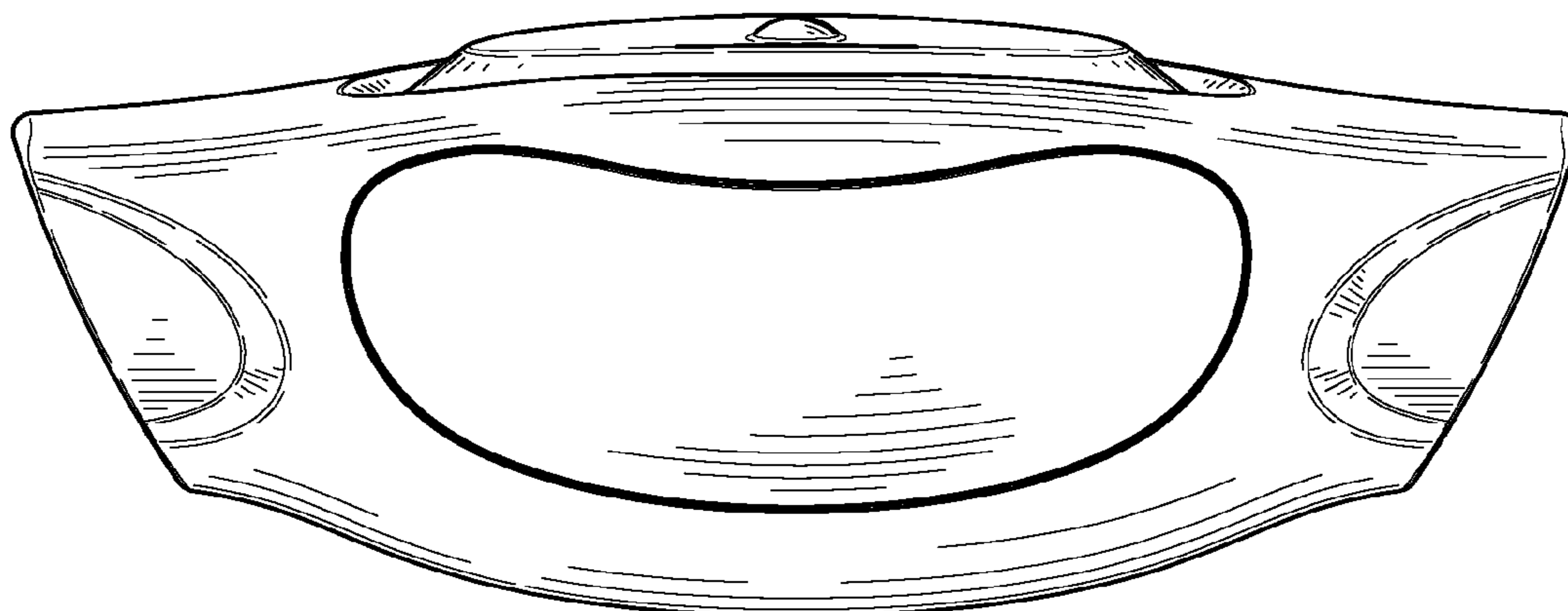

Fig. 11

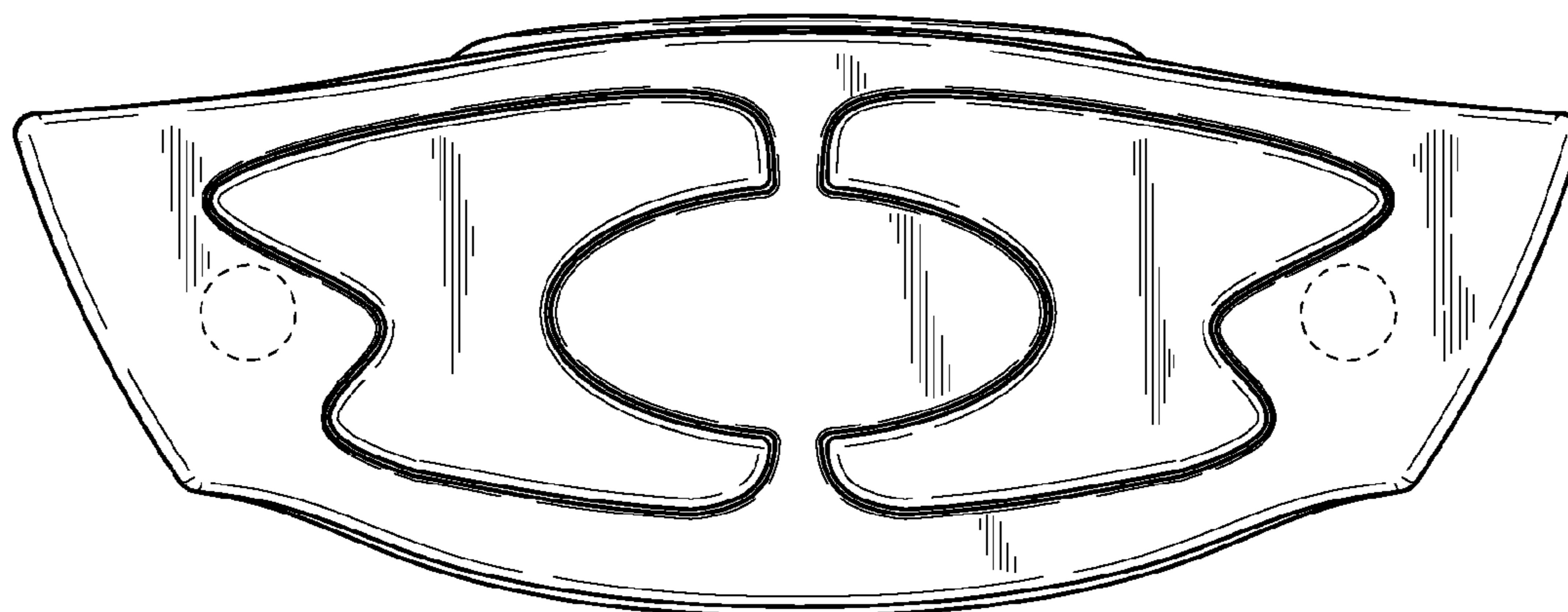

Fig. 12

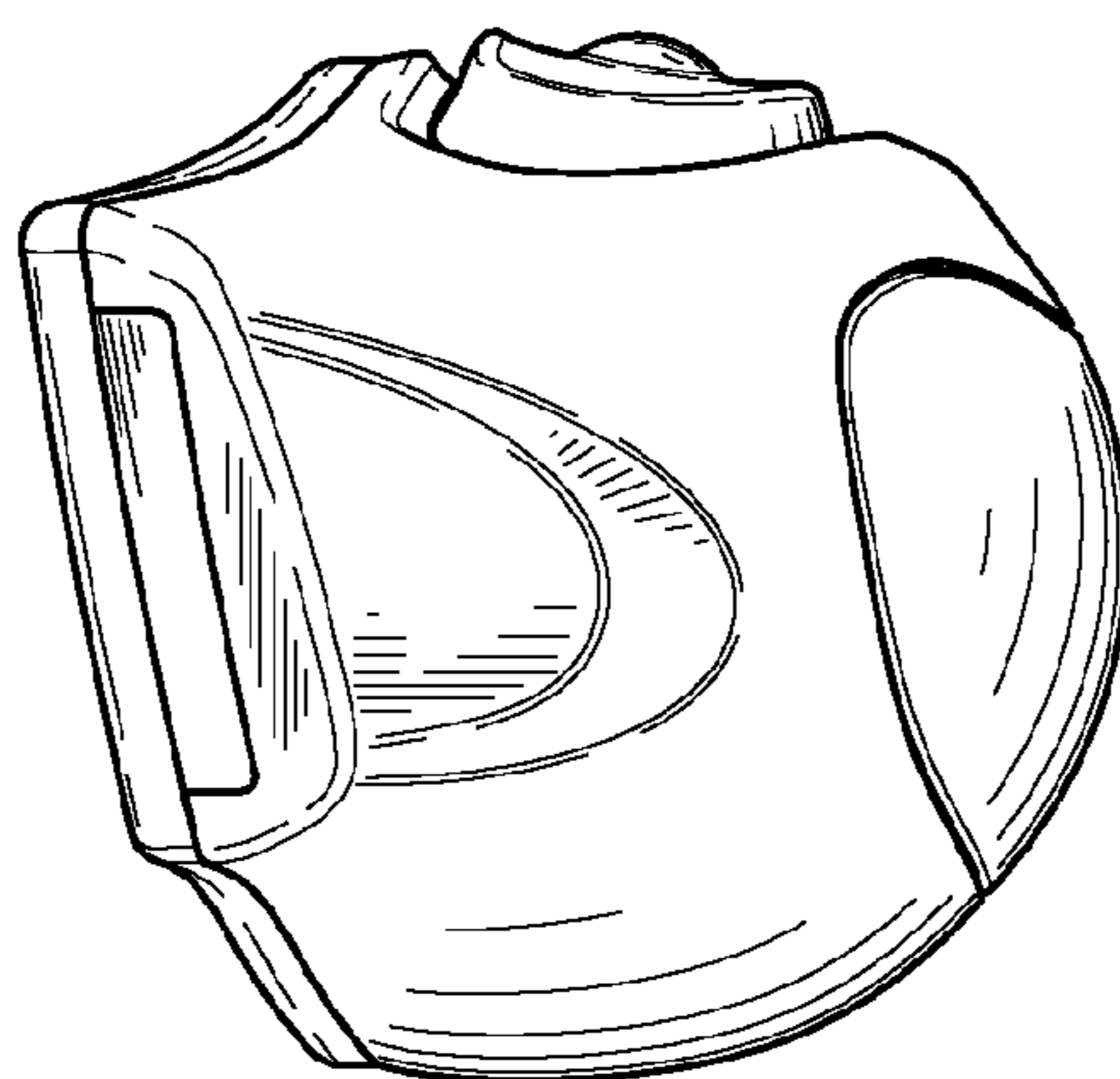

Fig. 13

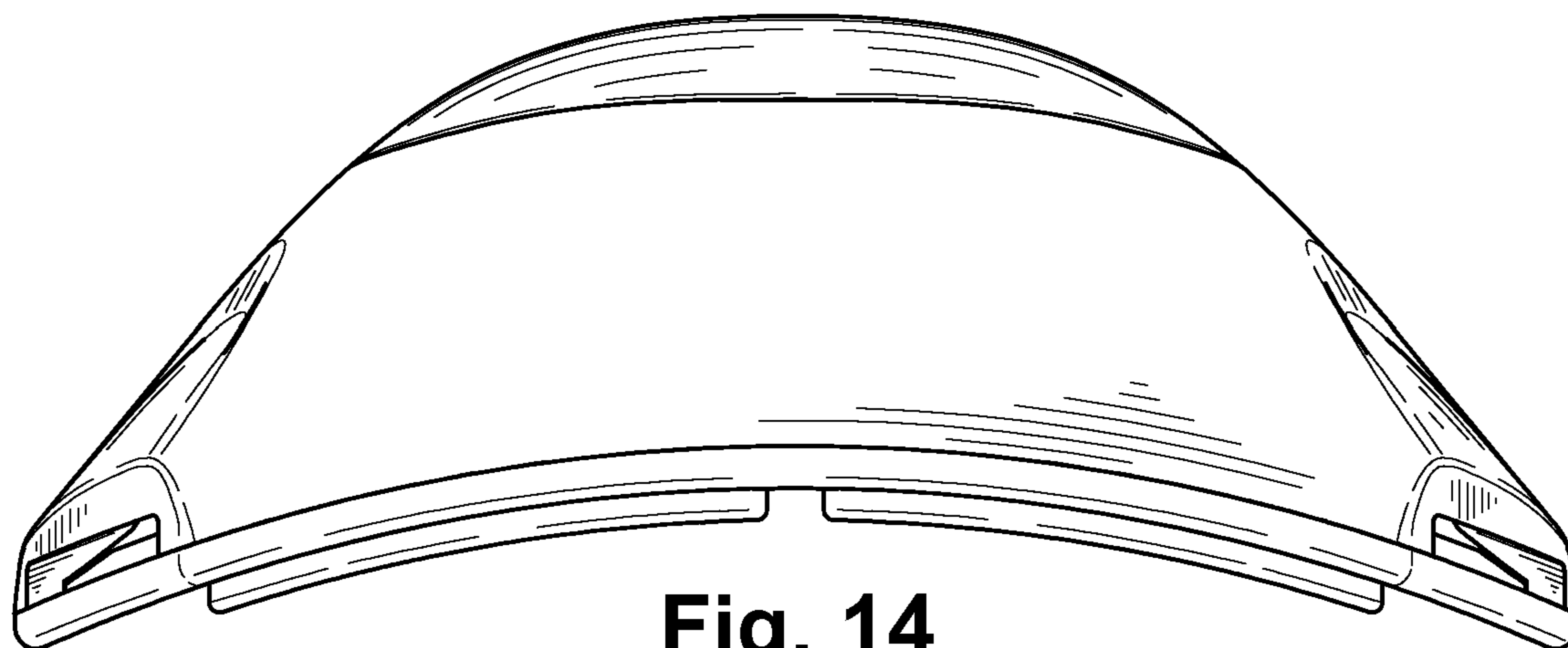

Fig. 14

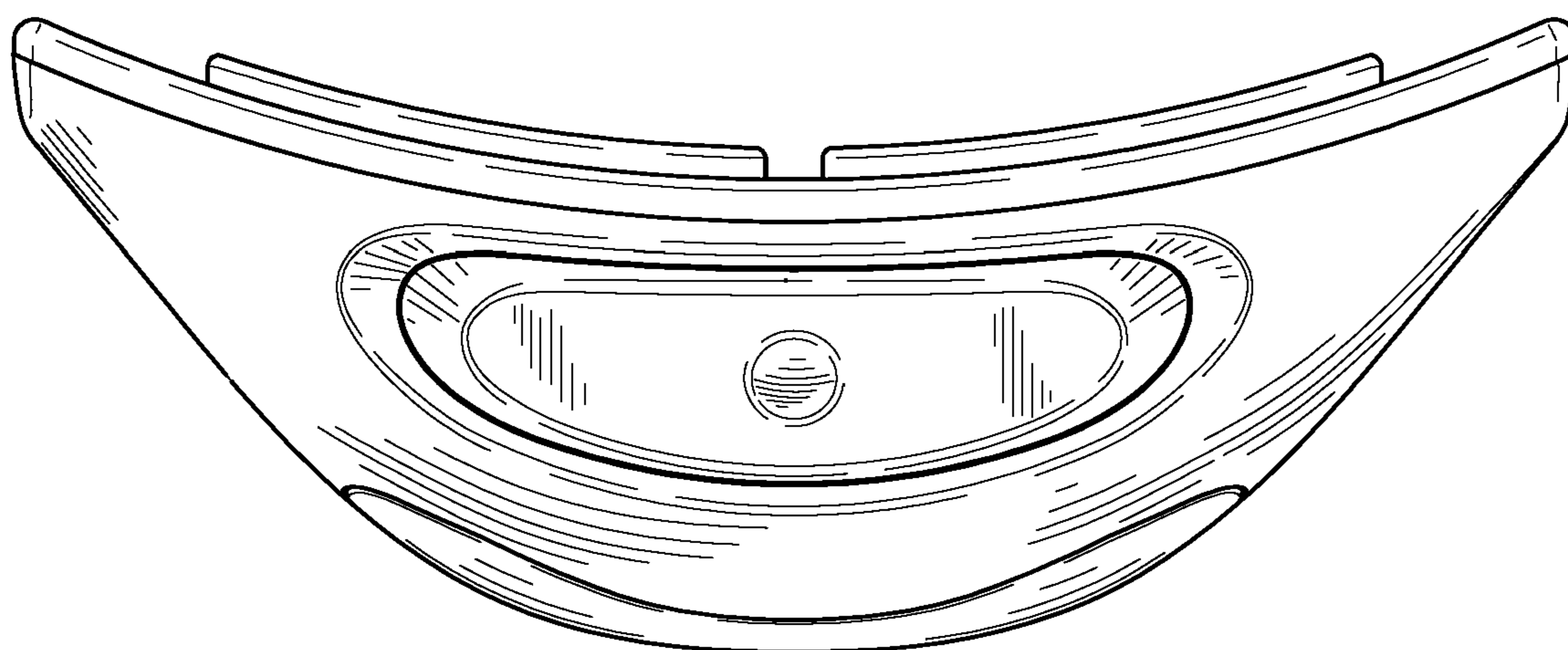

Fig. 15

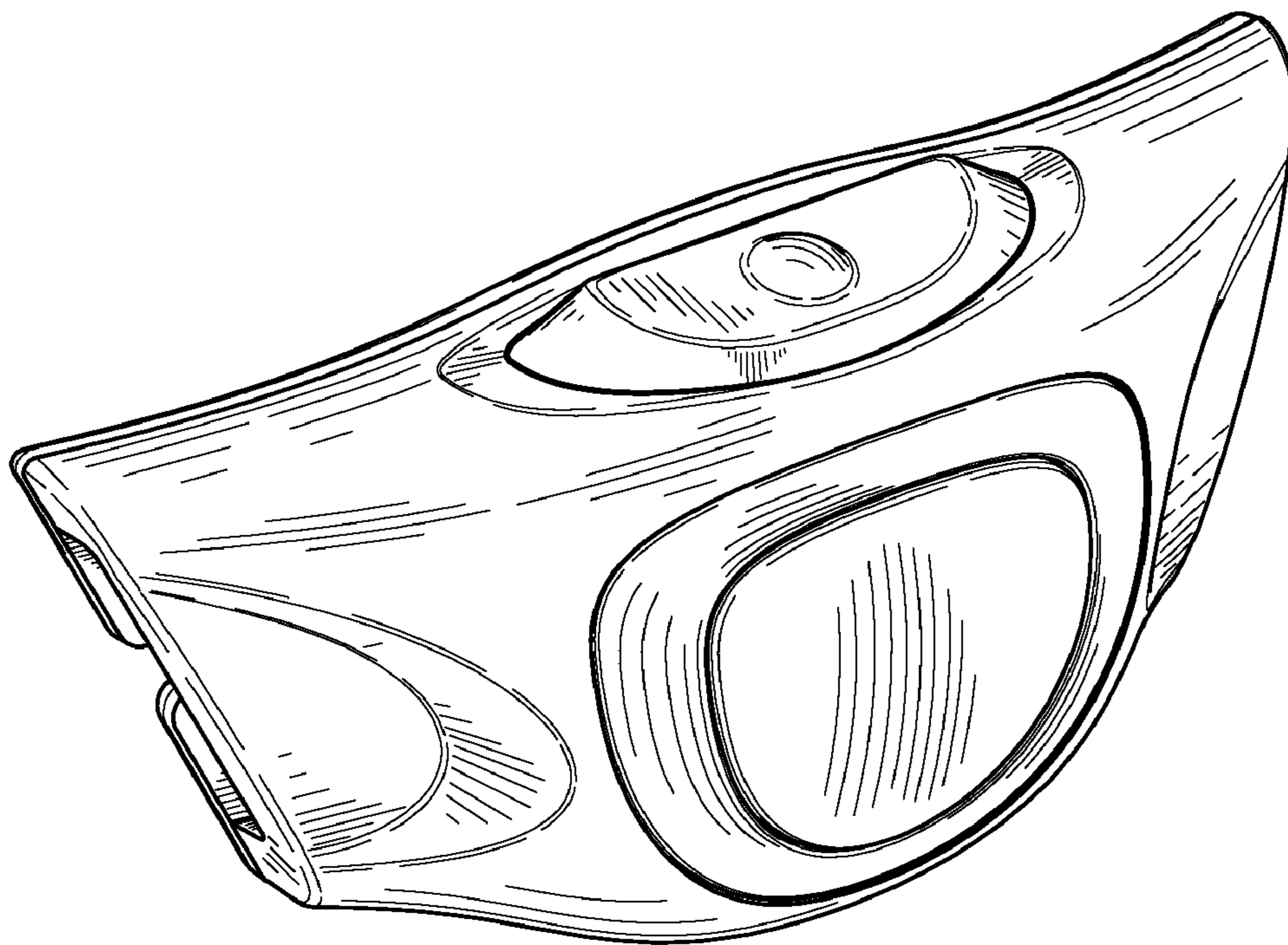

Fig. 16

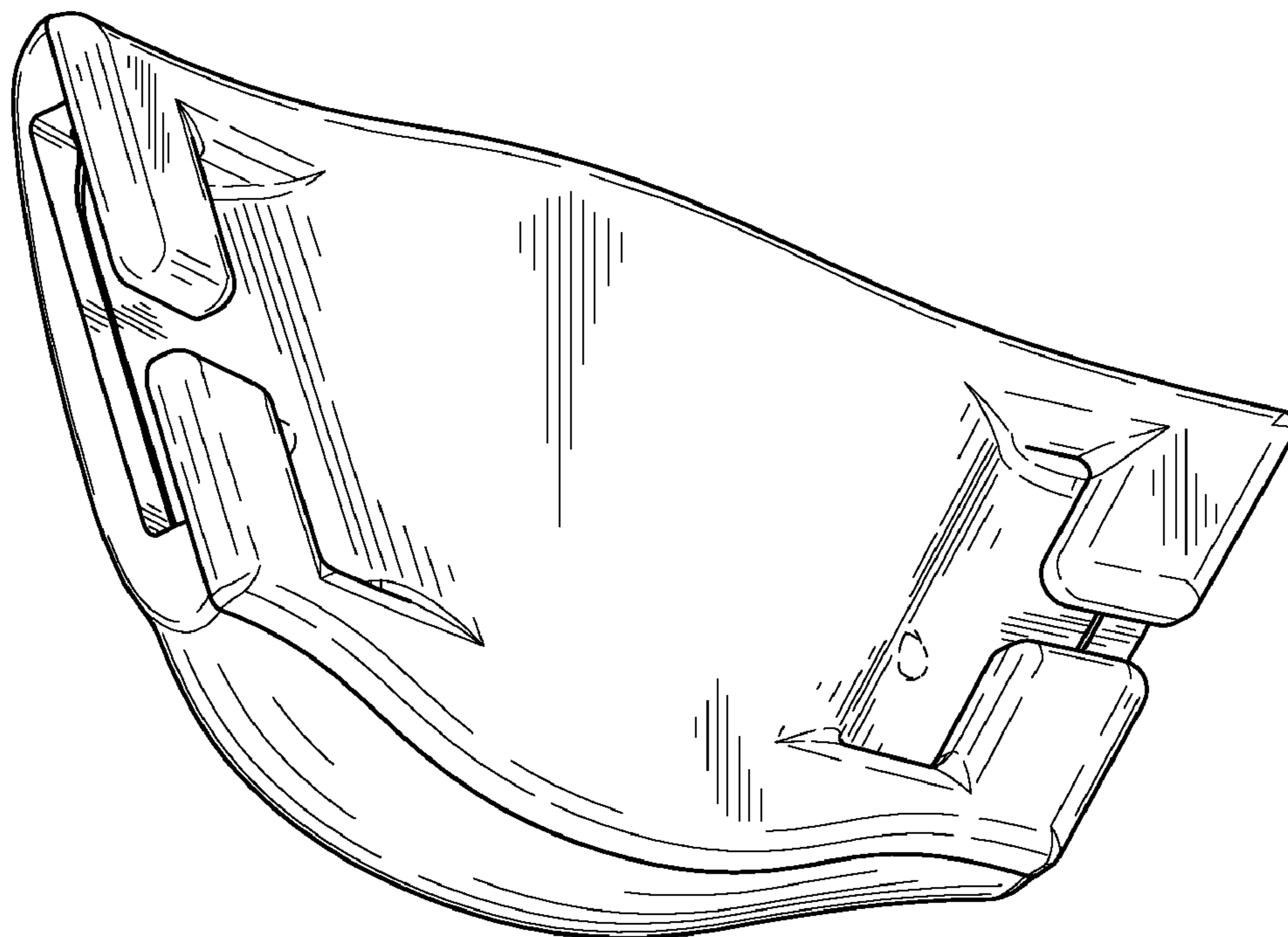

Fig. 17

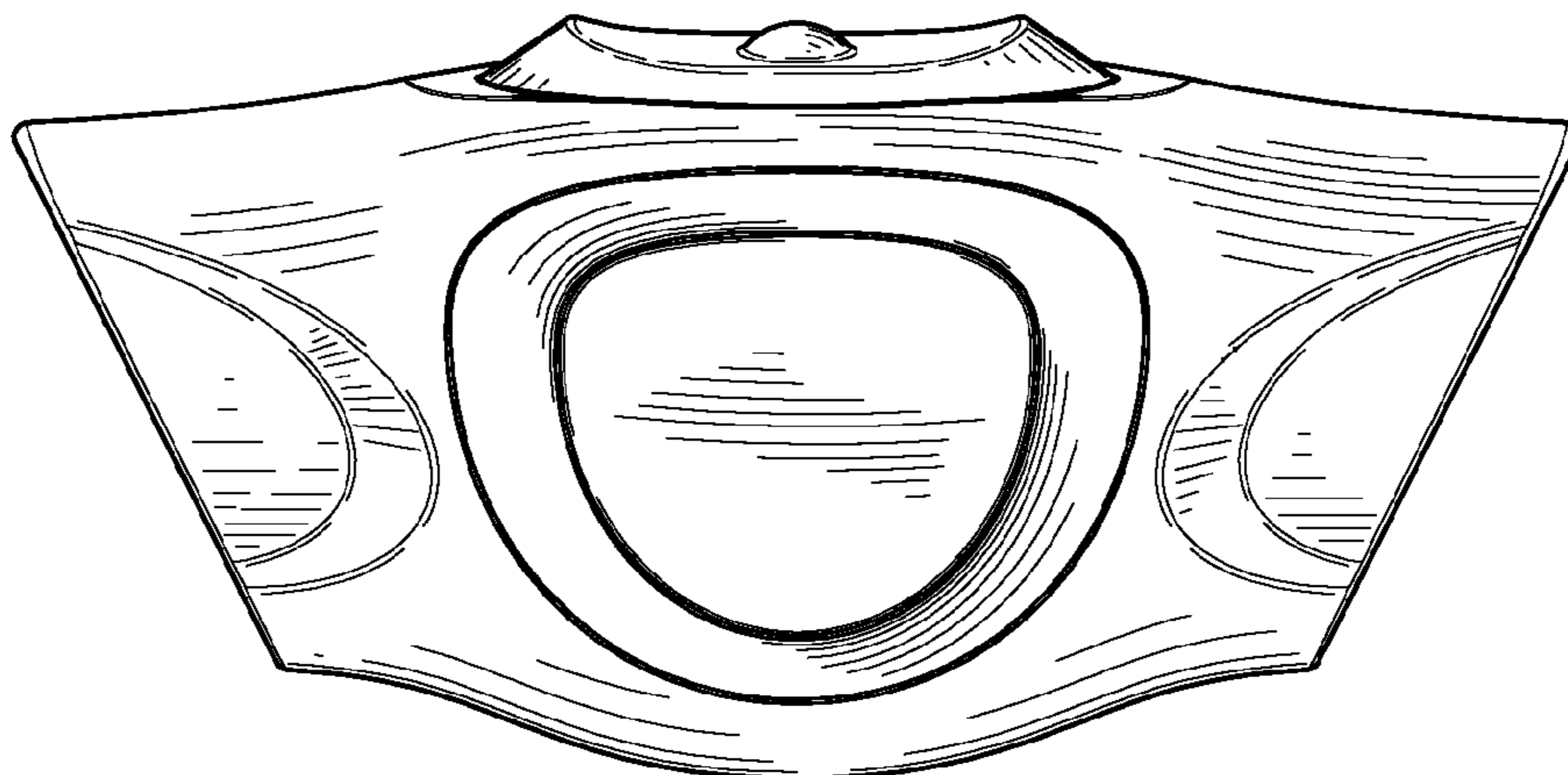

Fig. 18

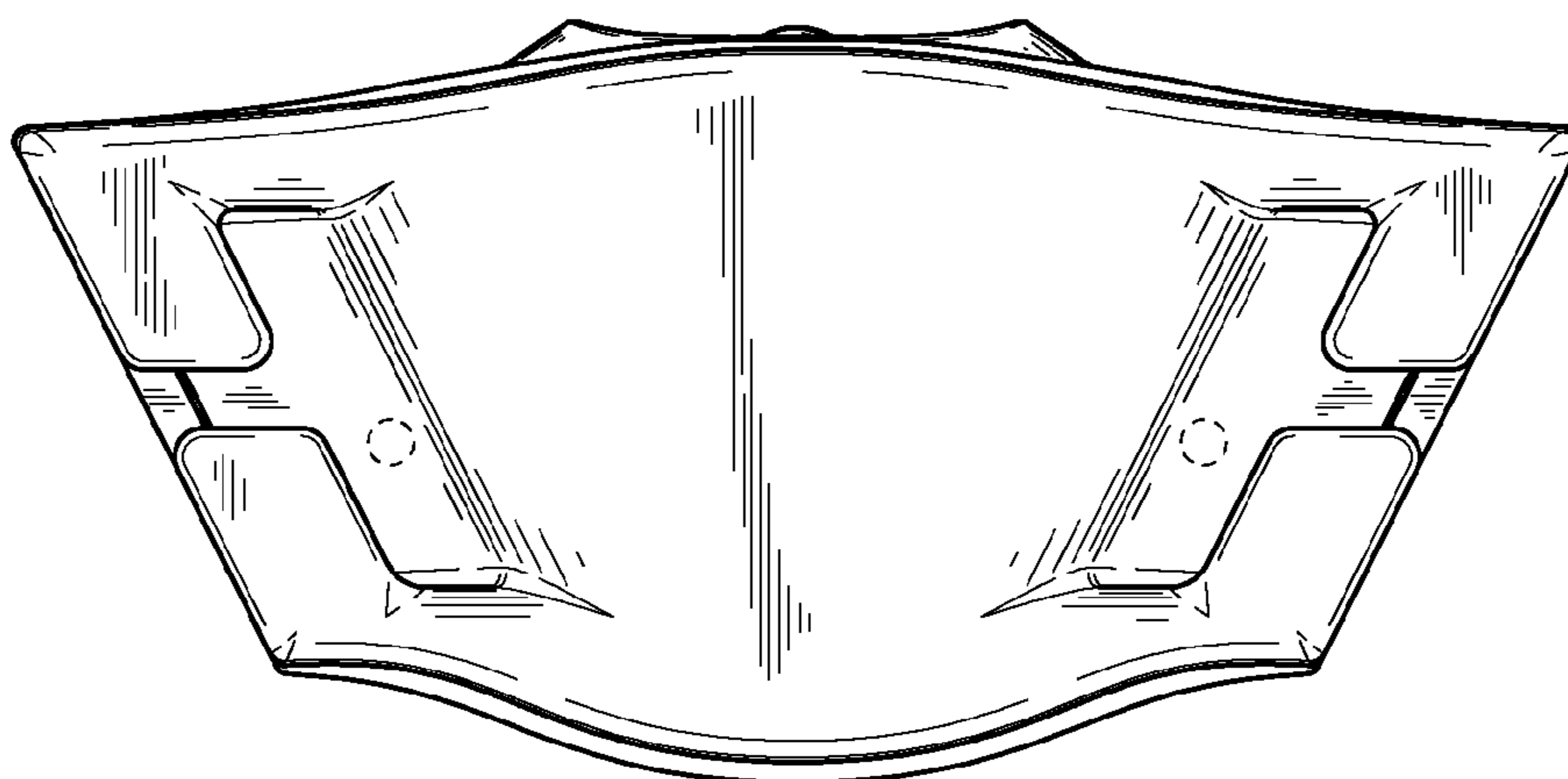

Fig. 19

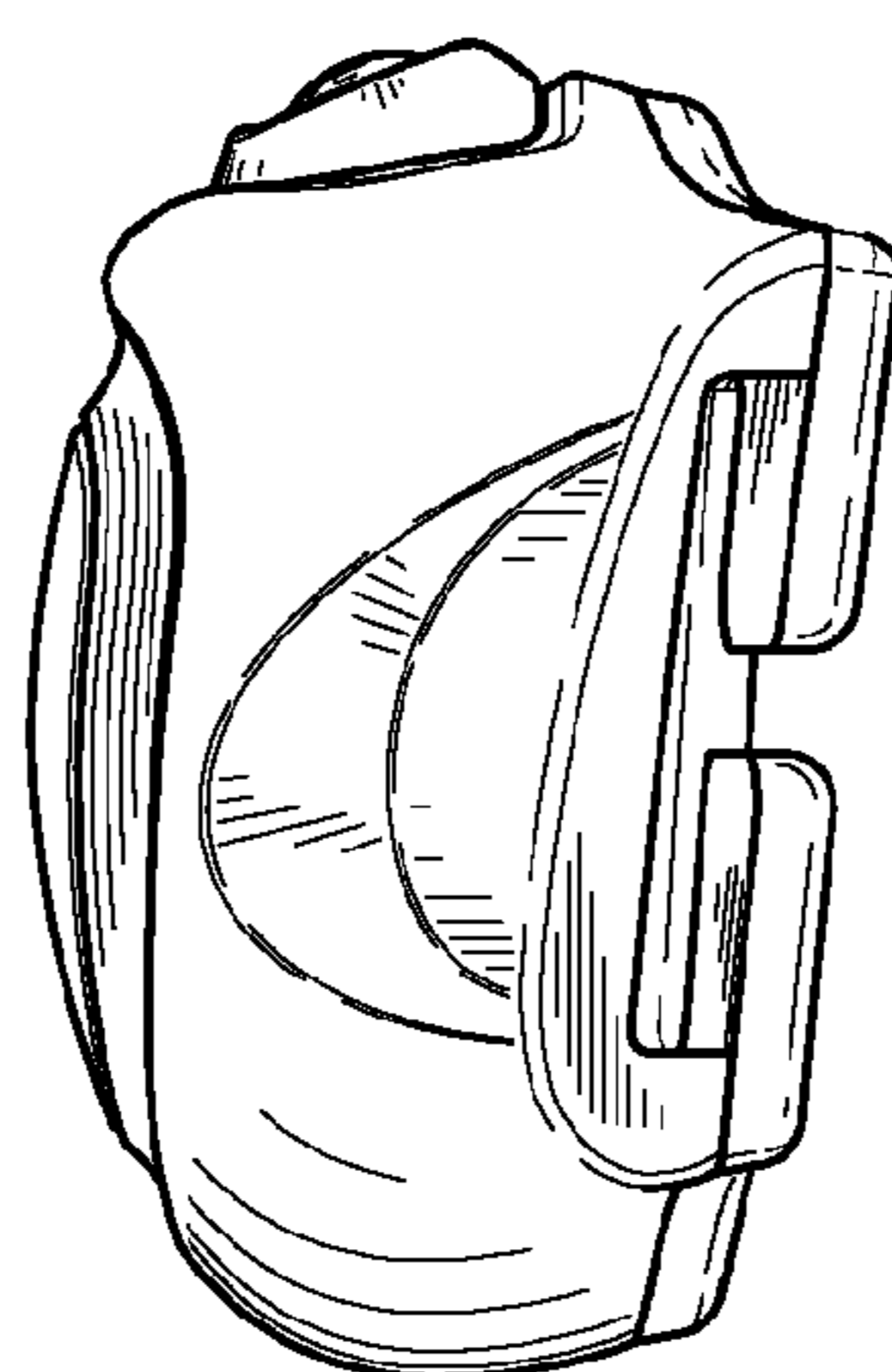

Fig. 20

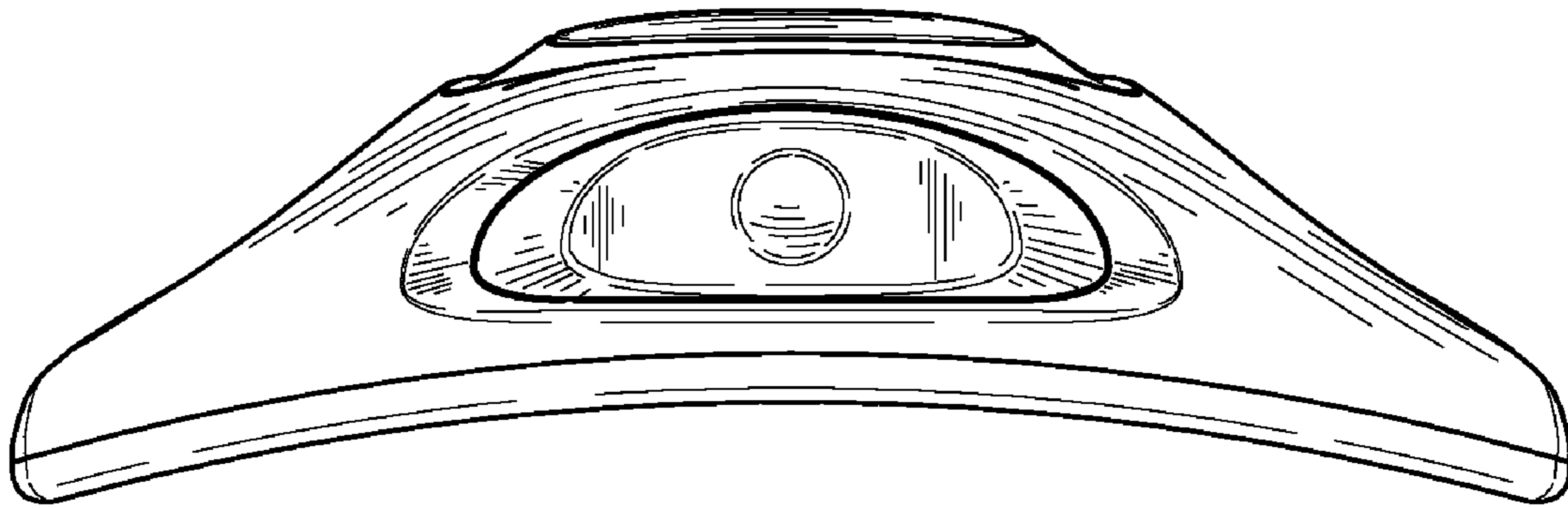

Fig. 21

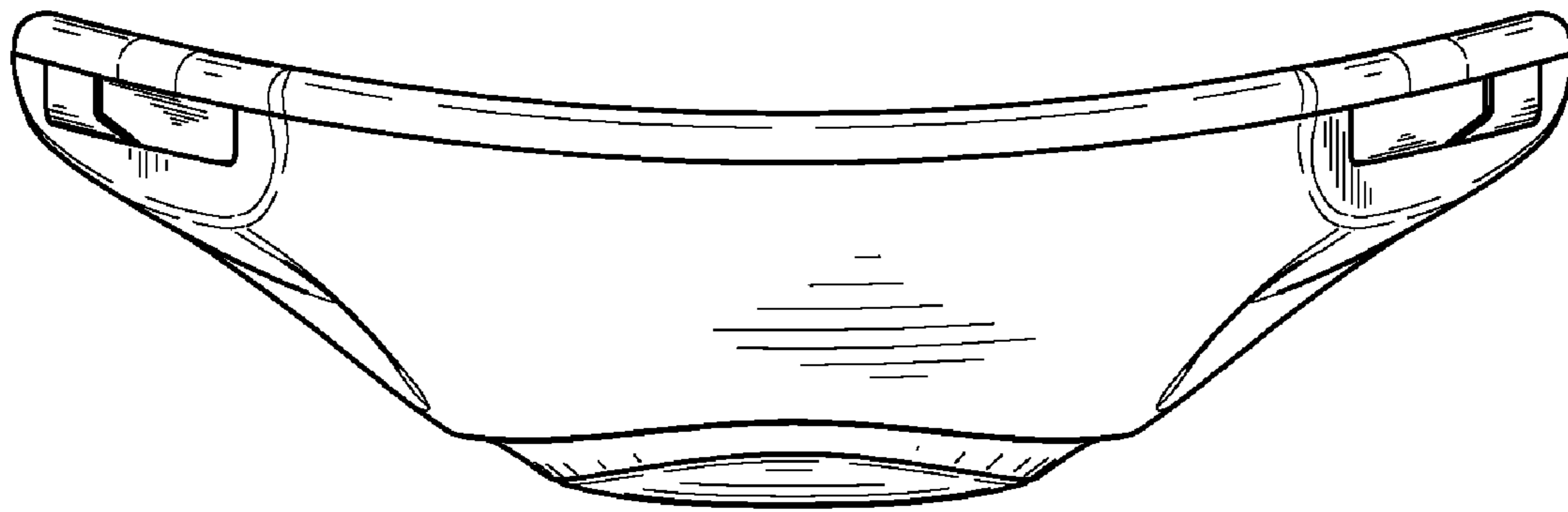

Fig. 22