



US00D625807S

(12) **United States Design Patent**
Leroy et al.

(10) **Patent No.:** **US D625,807 S**
(45) **Date of Patent:** **** Oct. 19, 2010**

(54) **SURGICAL INSTRUMENT FOR USE IN SINGLE-ACCESS SURGERY**

(75) Inventors: **Joel Leroy**, Bouvigny-Boyeffles (FR);
Sebastian Wagner, Bretten (DE)

(73) Assignee: **Karl Storz GmbH & Co. KG** (DE)

(**) Term: **14 Years**

(21) Appl. No.: **29/344,799**

(22) Filed: **Oct. 5, 2009**

(30) **Foreign Application Priority Data**

Apr. 3, 2009 (EM) 001117782-0003

(51) **LOC (9) Cl.** **24-02**

(52) **U.S. Cl.** **D24/143**

(58) **Field of Classification Search** D24/143,
D24/133, 146-147, 137-138, 148-149, 144-145;
D8/53-55, 60; 600/197, 217, 218, 226; 606/205-207,
606/167, 170, 48, 51-52

See application file for complete search history.

(56) **References Cited**

U.S. PATENT DOCUMENTS

3,446,211	A *	5/1969	Markham	606/207
D272,089	S *	1/1984	Glassman	D24/133
5,466,241	A *	11/1995	Leroy et al.	606/148
RE36,795	E *	7/2000	Rydell	606/48
6,688,312	B2 *	2/2004	Yeretsian	606/205
7,666,206	B2 *	2/2010	Taniguchi et al.	606/206
7,699,790	B2 *	4/2010	Simpson	606/167
2007/0049966	A1 *	3/2007	Bonadio et al.	606/206
2007/0118115	A1 *	5/2007	Artale et al.	606/51
2008/0172085	A1 *	7/2008	Chiu et al.	606/205
2009/0054733	A1 *	2/2009	Marescaux et al.	600/149

2009/0209991	A1 *	8/2009	Hinchliffe et al.	606/170
2010/0076459	A1 *	3/2010	Farascioni	606/143
2010/0087818	A1 *	4/2010	Cunningham	606/207
2010/0106183	A1 *	4/2010	Lee et al.	606/206

* cited by examiner

Primary Examiner—Ian Simmons

Assistant Examiner—Wan Laymon

(74) *Attorney, Agent, or Firm*—St. Onge Steward Johnston & Reens LLC

(57) **CLAIM**

The ornamental design for an surgical instrument for use in single-access surgery, as shown and described.

DESCRIPTION

FIG. 1 is a left side perspective view of an surgical instrument for use in single-access surgery in accordance with the new design;

FIG. 2 is a right side elevation view thereof;

FIG. 3 is a top plan view thereof;

FIG. 4 is a bottom plan view thereof;

FIG. 5 is a front elevation view thereof;

FIG. 6 is a rear elevation view thereof;

FIG. 7 is an enlarged perspective view of the area labeled “7” in FIG. 1; and,

FIG. 8 is an enlarged perspective view of the area labeled “8” in FIG. 1.

The broken line showing portions of the instrument for use in single-access surgery represent an internal boundary of the design, with the lines themselves and the areas within, forming no part of the claimed.

1 Claim, 4 Drawing Sheets

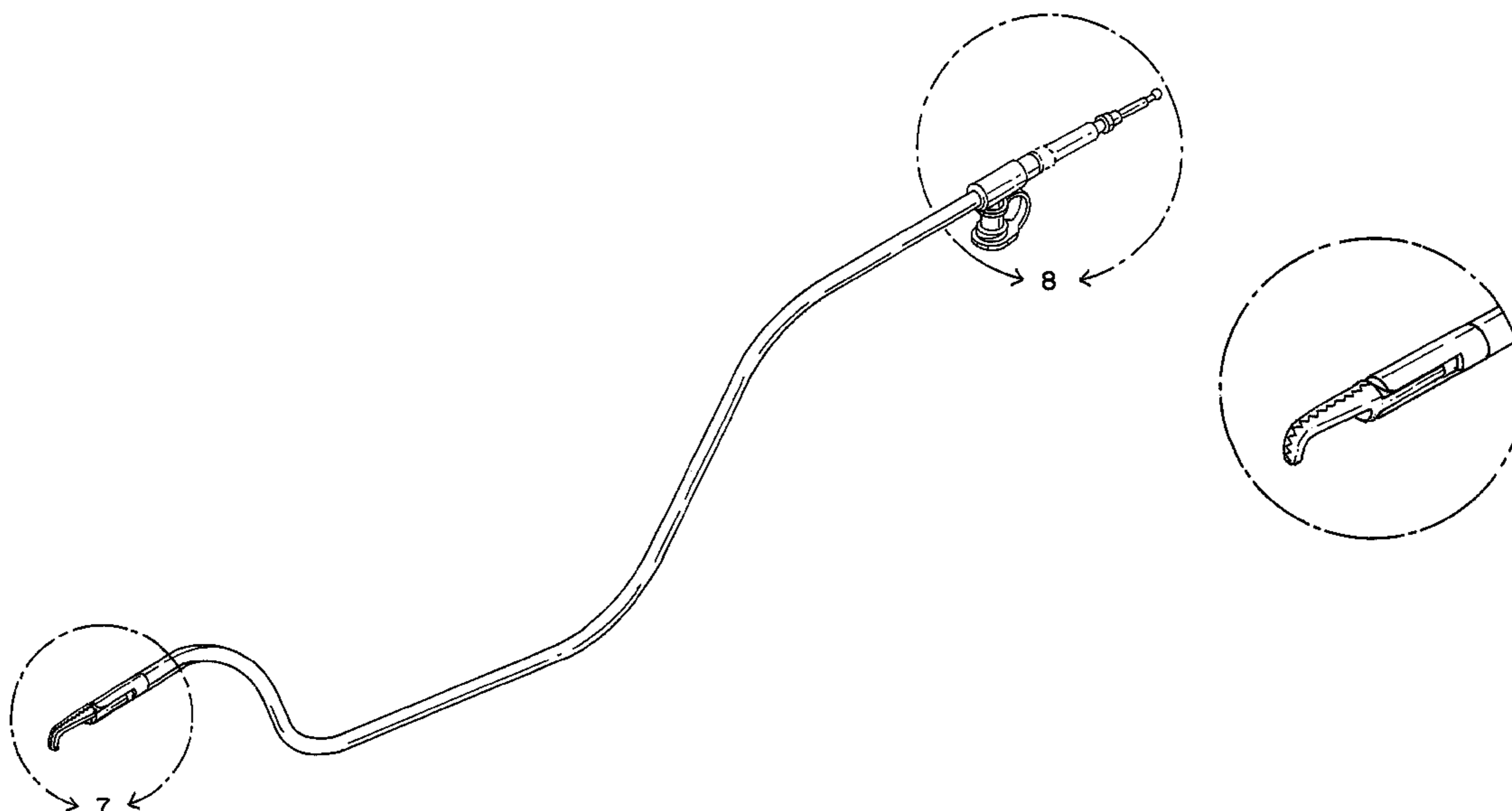

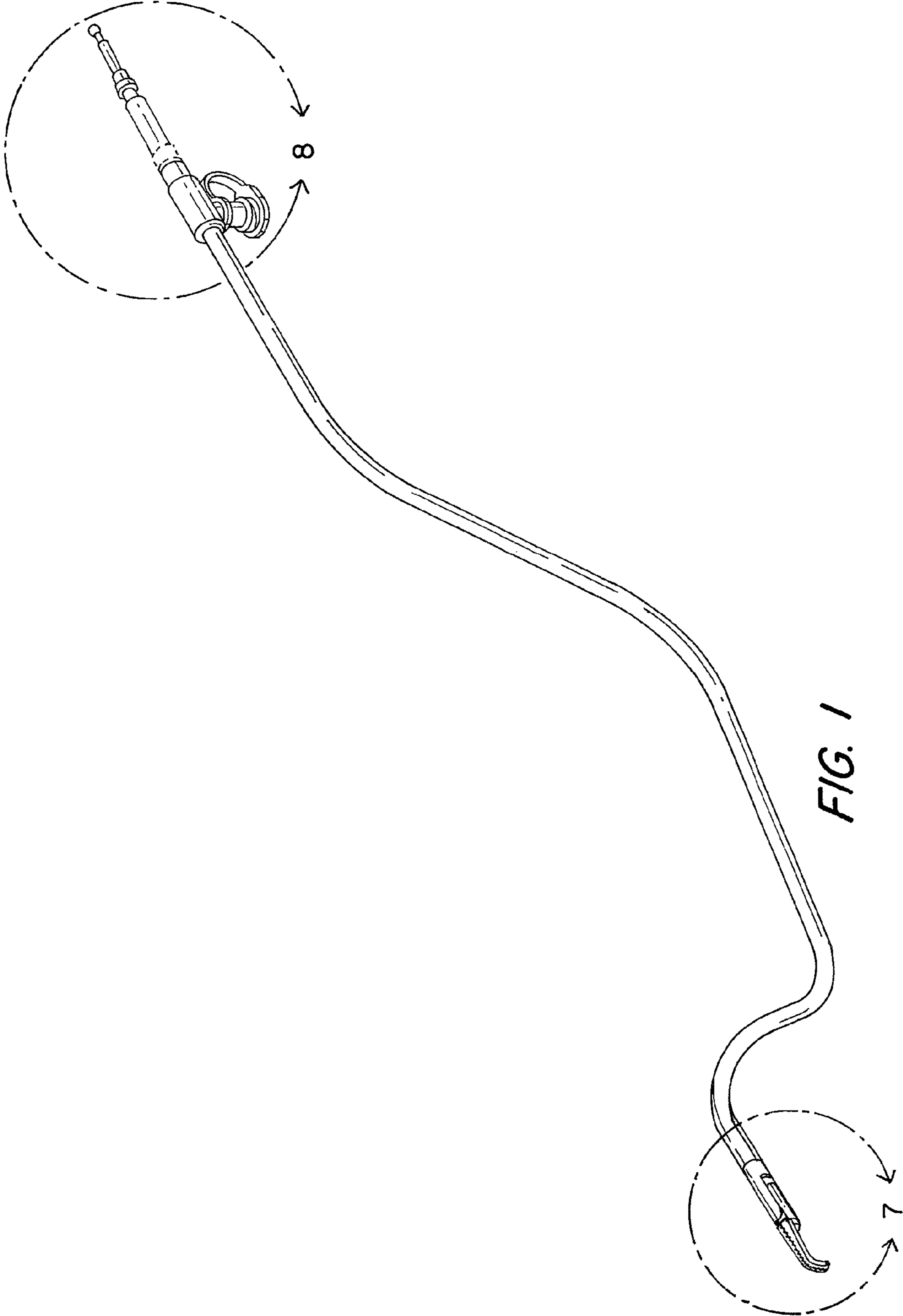

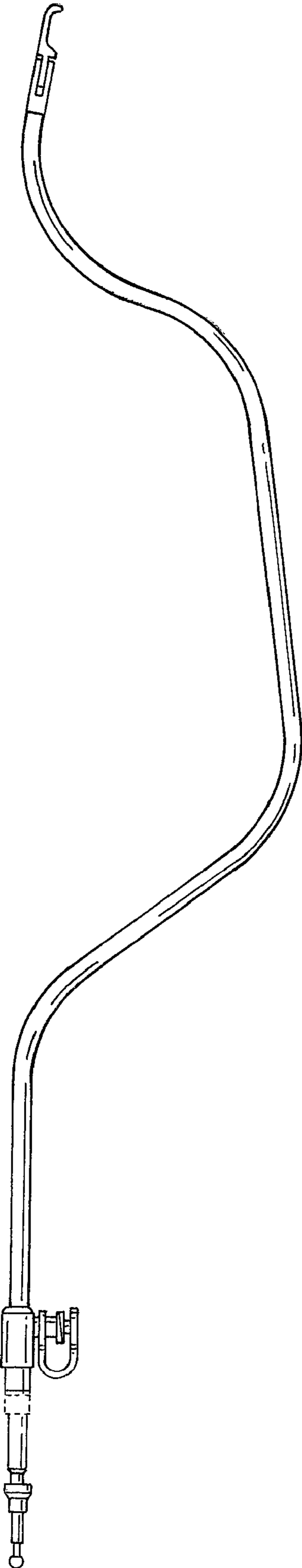

FIG. 2

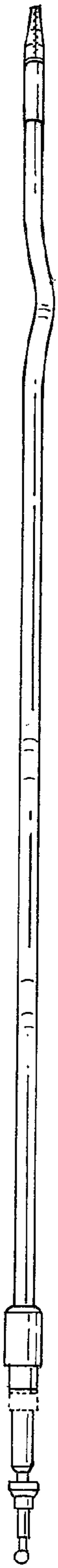

FIG. 3



FIG. 4

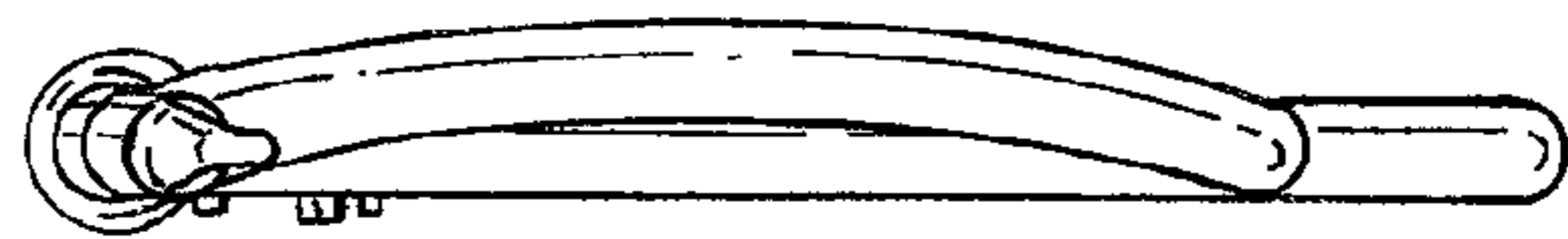

FIG. 5

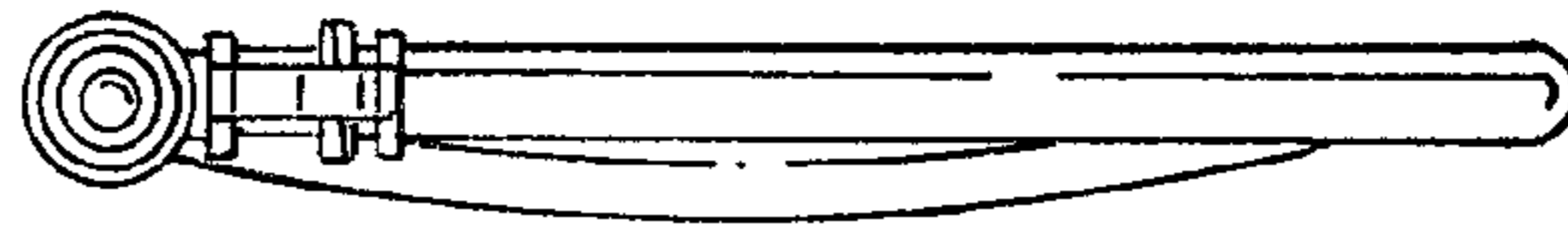

FIG. 6

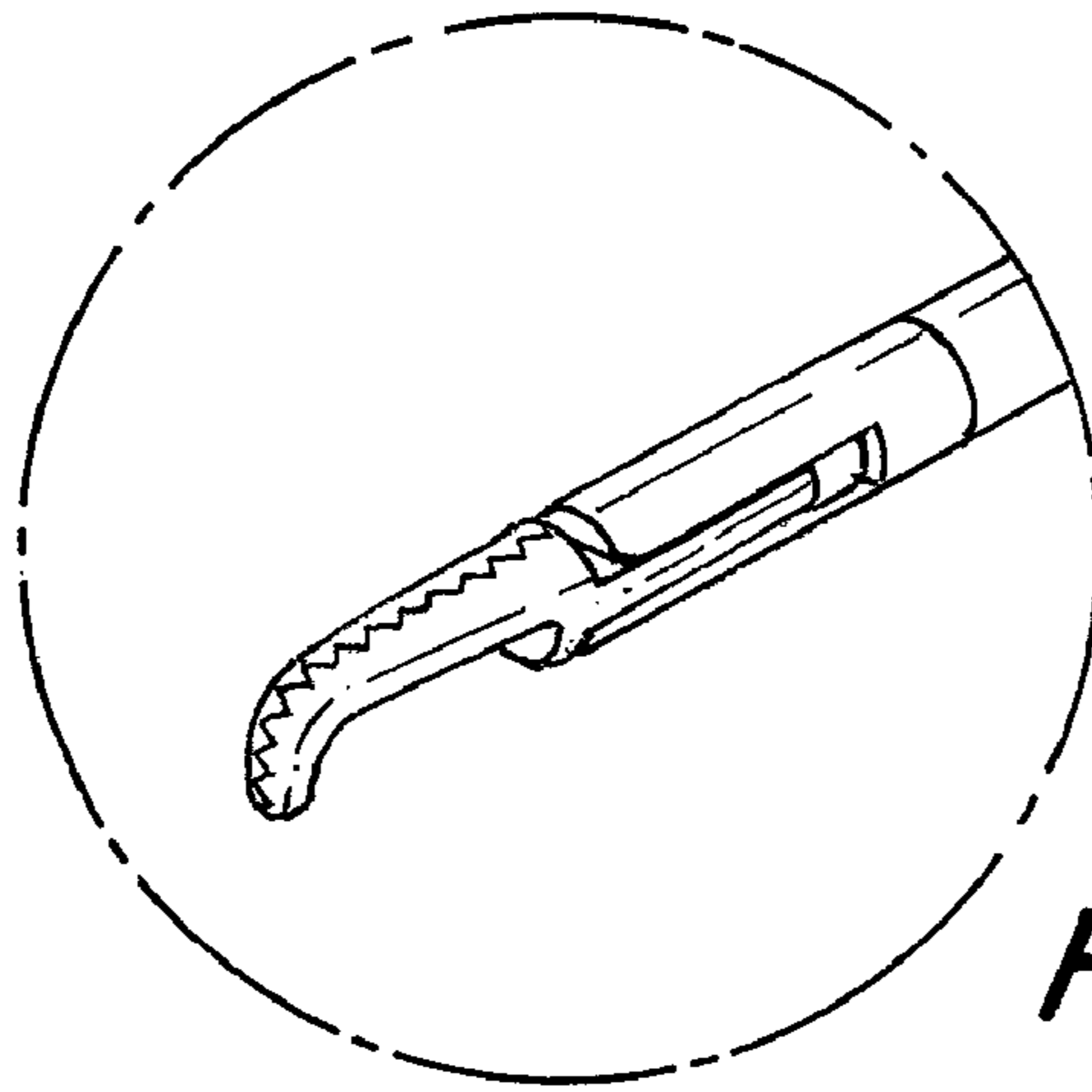

FIG. 7

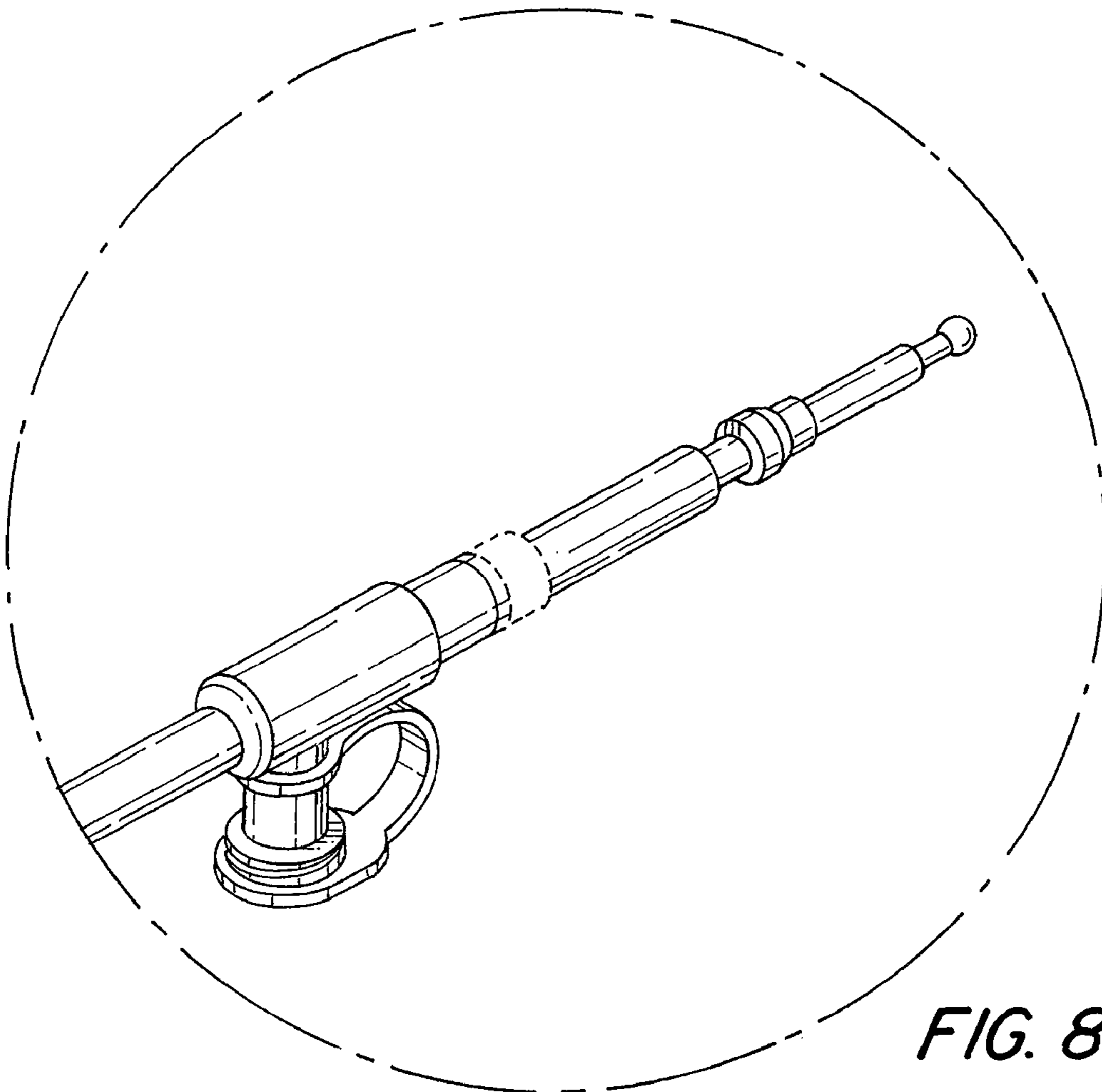

FIG. 8