

US00D625792S

(12) **United States Design Patent**
Rundberg et al.

(10) **Patent No.:** **US D625,792 S**

(45) **Date of Patent:** **** Oct. 19, 2010**

(54) **LAVATORY**

(75) Inventors: **Michelle L. Rundberg**, Jackson, WI (US); **Dale S. Dilulio**, Saukville, WI (US)

(73) Assignee: **Bradley Fixtures Corporation**, Menomonee Falls, WI (US)

(**) Term: **14 Years**

(21) Appl. No.: **29/345,991**

(22) Filed: **Oct. 23, 2009**

(51) **LOC (9) Cl.** **23-02**

(52) **U.S. Cl.** **D23/308**

(58) **Field of Classification Search** D23/284-287, D23/293.1, 303, 308

See application file for complete search history.

(56) **References Cited**

U.S. PATENT DOCUMENTS

D468,815 S	1/2003	Kahle et al.	
D474,835 S	5/2003	Kahle et al.	
D501,674 S	2/2005	Adkison	
D539,879 S *	4/2007	Stein	D23/293.1
D545,415 S *	6/2007	Tani et al.	D23/293.1
D560,782 S *	1/2008	Marshall et al.	D23/293.1
D560,783 S	1/2008	Marshall et al.	
D560,784 S	1/2008	Marshall et al.	
D611,128 S *	3/2010	Soulier	D23/293.1
2005/0223485 A1	10/2005	Nijhof	

OTHER PUBLICATIONS

Blanco Zeus product from Cosentino S.A., Showroom Bathroom, printed on Jul. 15, 2009 from http://www.silestone.com/uk/showroom_wc.asp, 1 page.

Quick Drain™ USA, "Mechanical drawings of low profile side outlet shower drain and linear wall channel drains from Quick Drain USA",

accessed from http://www.quickdrainusa.com/drawings/quick_drain_drawings.html on Apr. 13, 2009, 7 pages.

Quick Drain USA: Updating the Old Round Center Drain, published at least by Apr. 13, 2009, 1 page.

Neo-Metro, "5/5" Ebb® Concept Wall Mounted", last revised on May 8, 2008, 4 pages.

Neo-Metro, "Installation Instructions", date revised Aug. 28, 2008, 1 page.

Neo-Metro, "Installation Instructions", date revised Jul. 31, 2008, 1 page.

Neo-Metro, images printed from website <http://www.neo-metro.com/images/lindewgs/sch9112-wm.jpg> on Feb. 5, 2009, 1 page.

* cited by examiner

Primary Examiner—Robert A Delehanty

(74) *Attorney, Agent, or Firm*—Foley & Lardner LLP

(57) **CLAIM**

We claim the ornamental design for a lavatory, as shown and described.

DESCRIPTION

FIG. 1 is a top perspective view of a claimed design;

FIG. 2 is a bottom perspective view thereof;

FIG. 3 is a top view thereof;

FIG. 4 is a bottom view thereof;

FIG. 5 is a front view thereof;

FIG. 6 is a rear view thereof;

FIG. 7 is a right side view thereof;

FIG. 8 is a left side view thereof; and,

FIG. 9 is a section view thereof taken along line 9—9 in FIG. 1.

The ornamental design which is claimed is shown in solid lines in the drawings: The broken lines in the drawings are for illustrative purposes only and form no part of the claimed design.

1 Claim, 7 Drawing Sheets

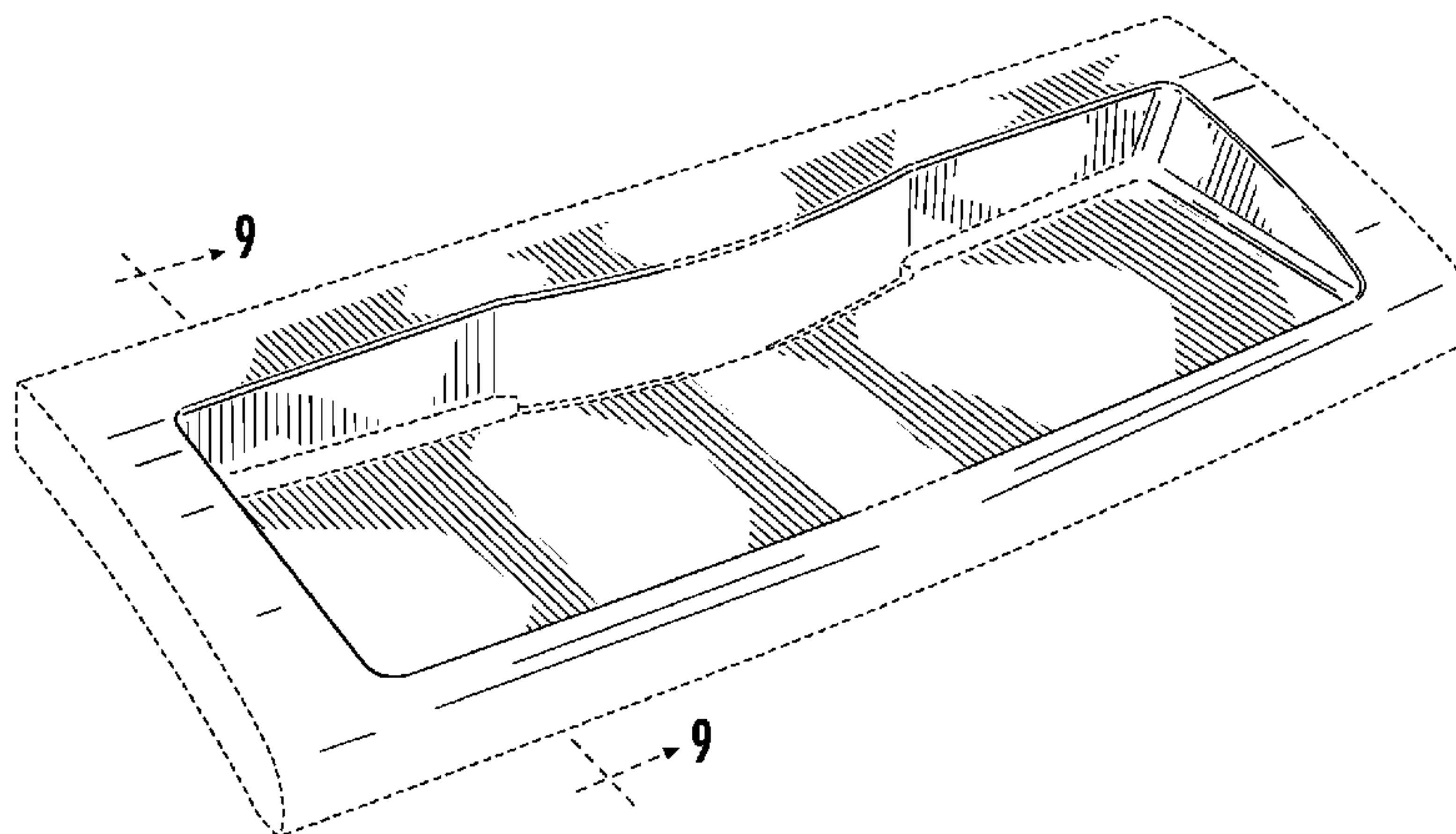

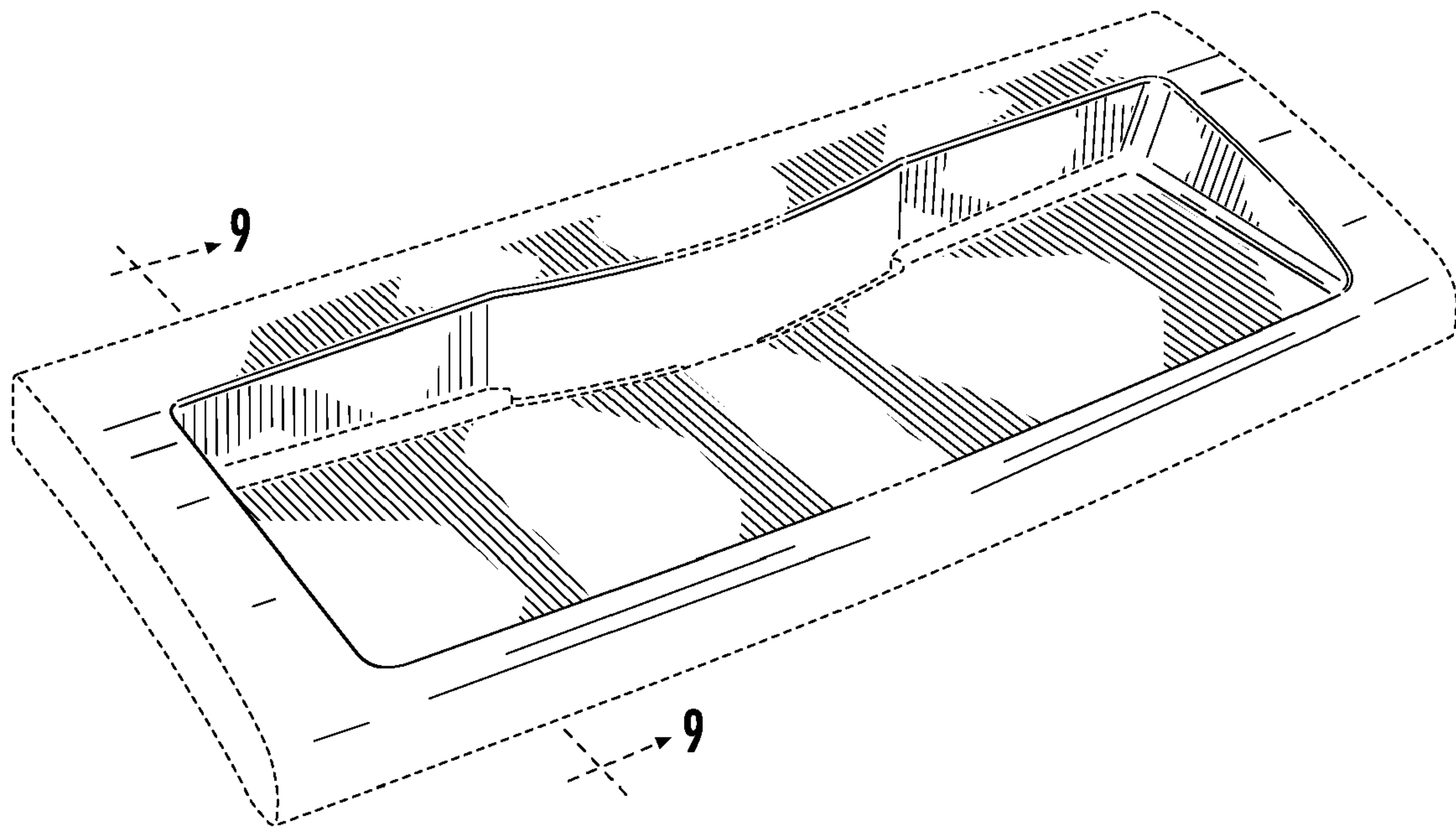

FIG. 1

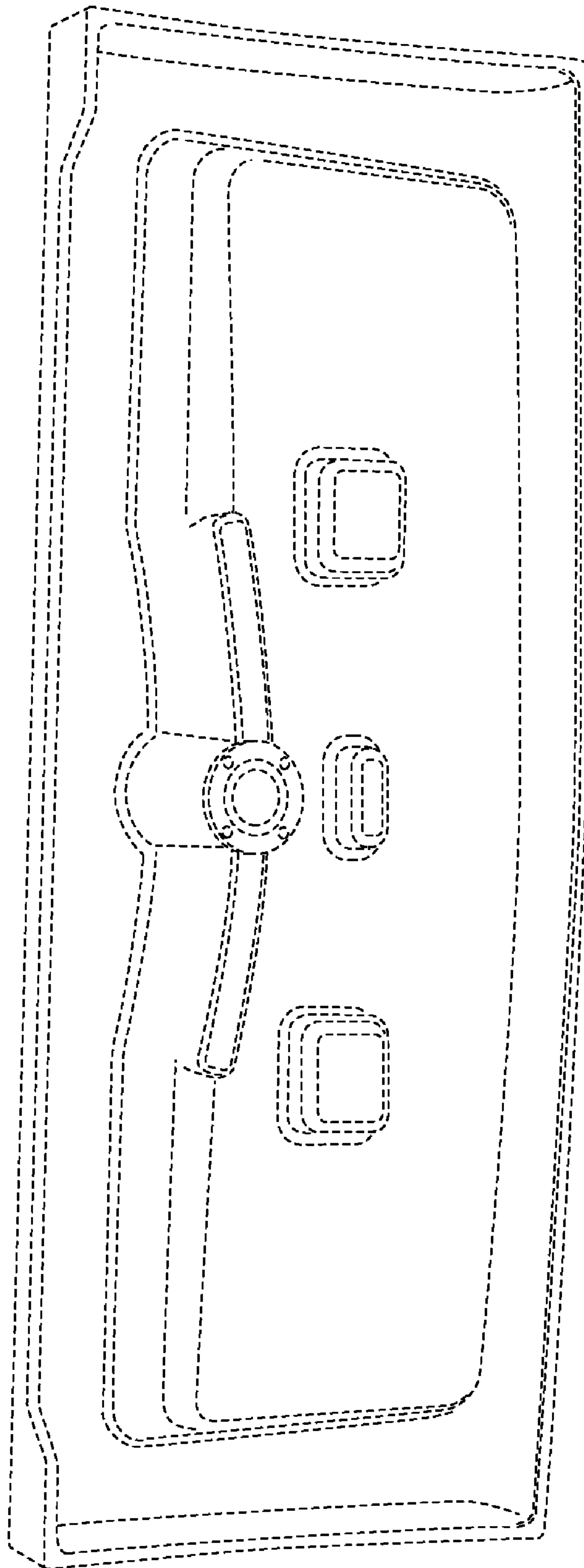

FIG. 2

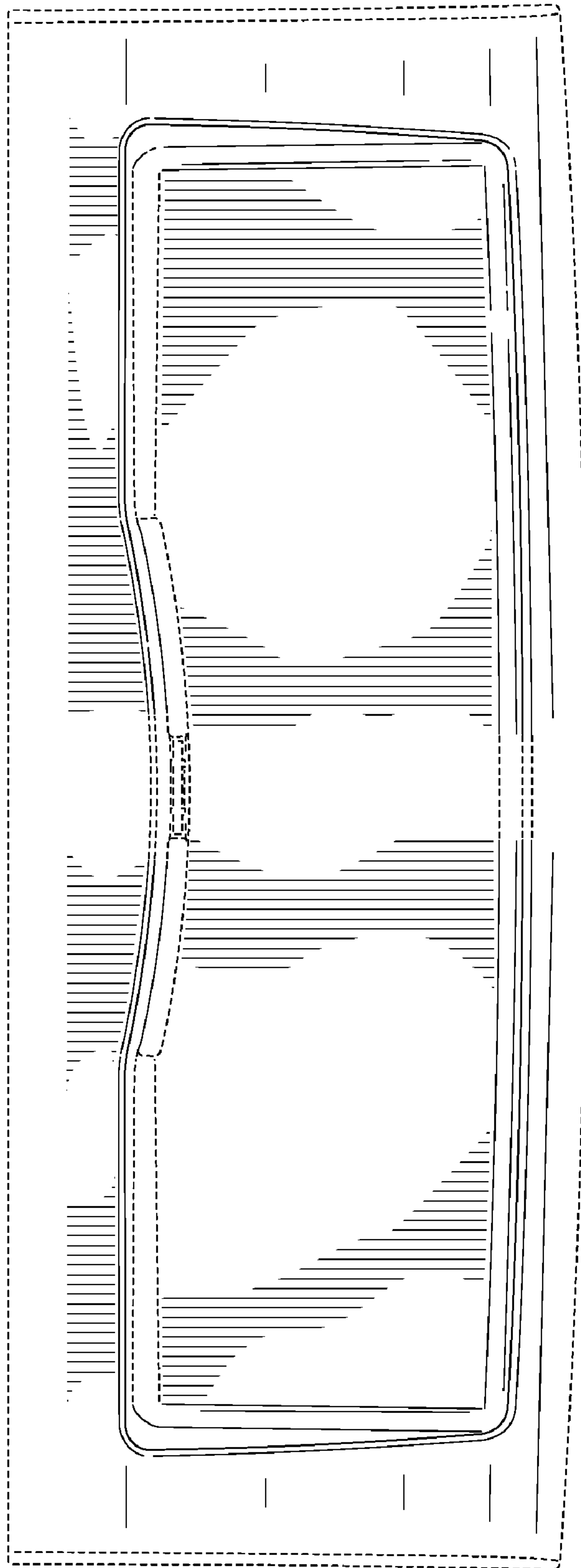

FIG. 3

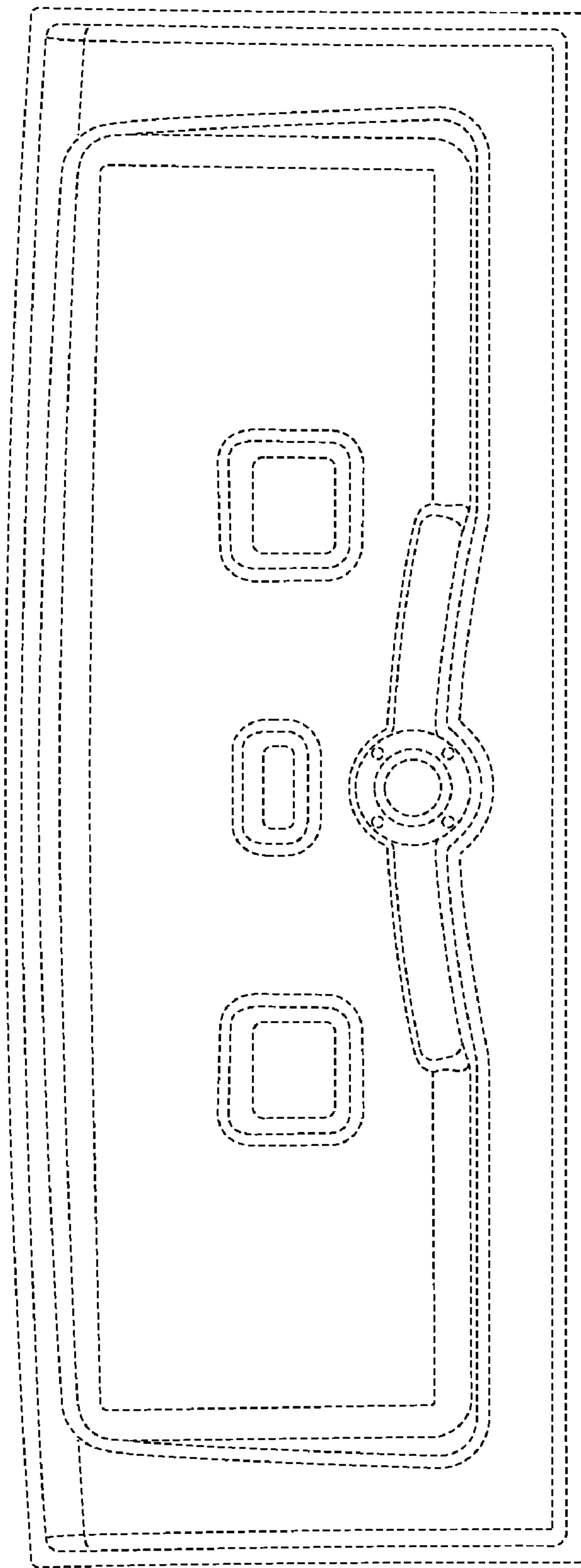

FIG. 4

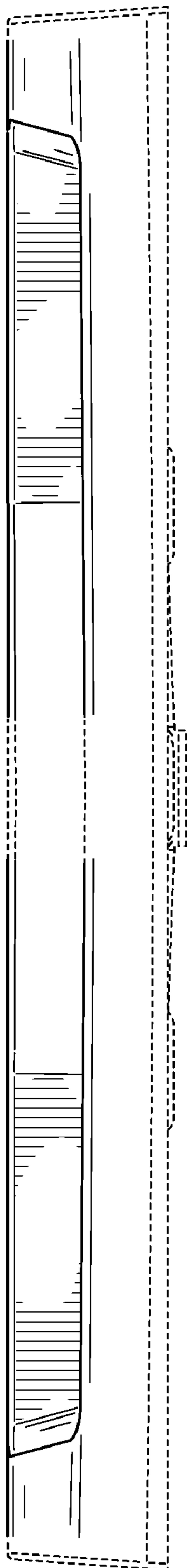

FIG. 5

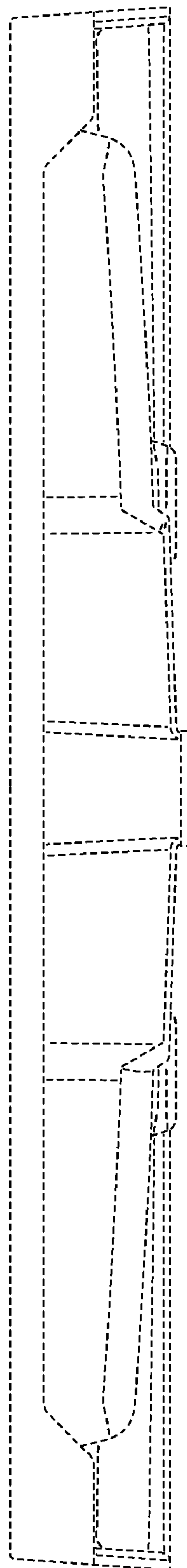

FIG. 6

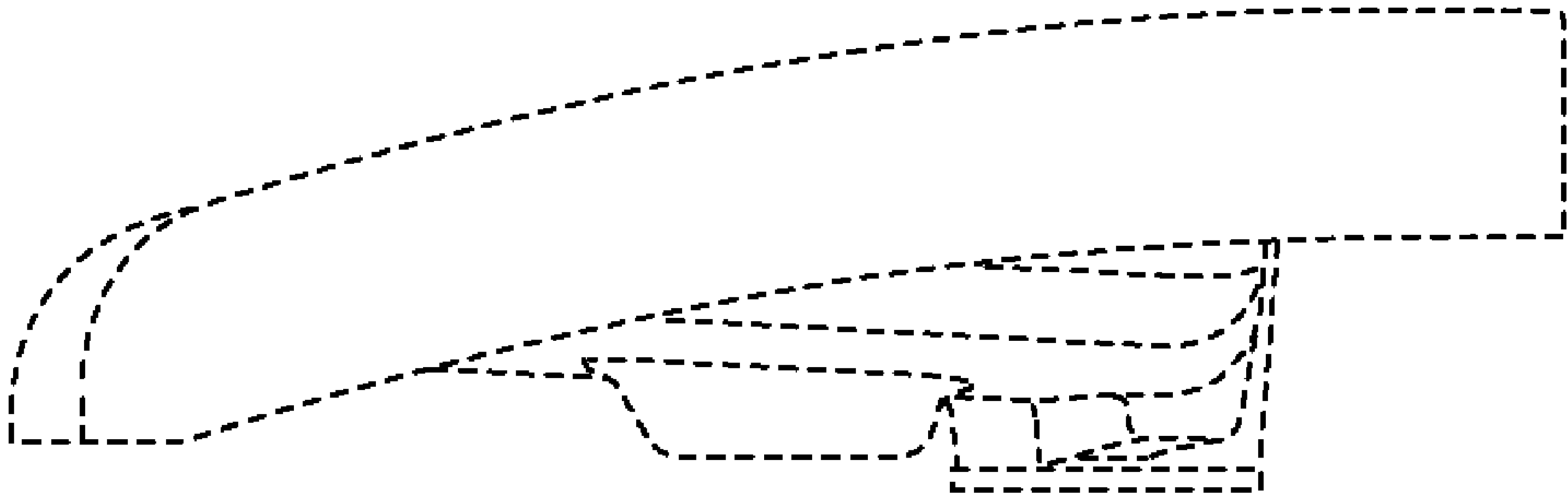

FIG. 7

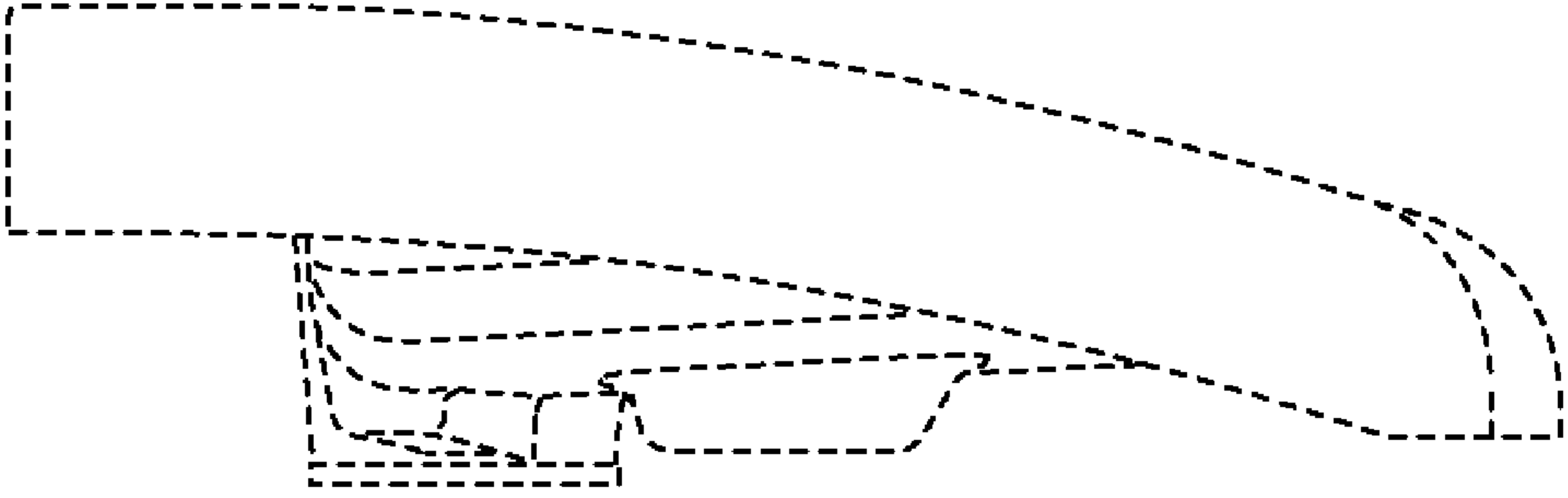

FIG. 8

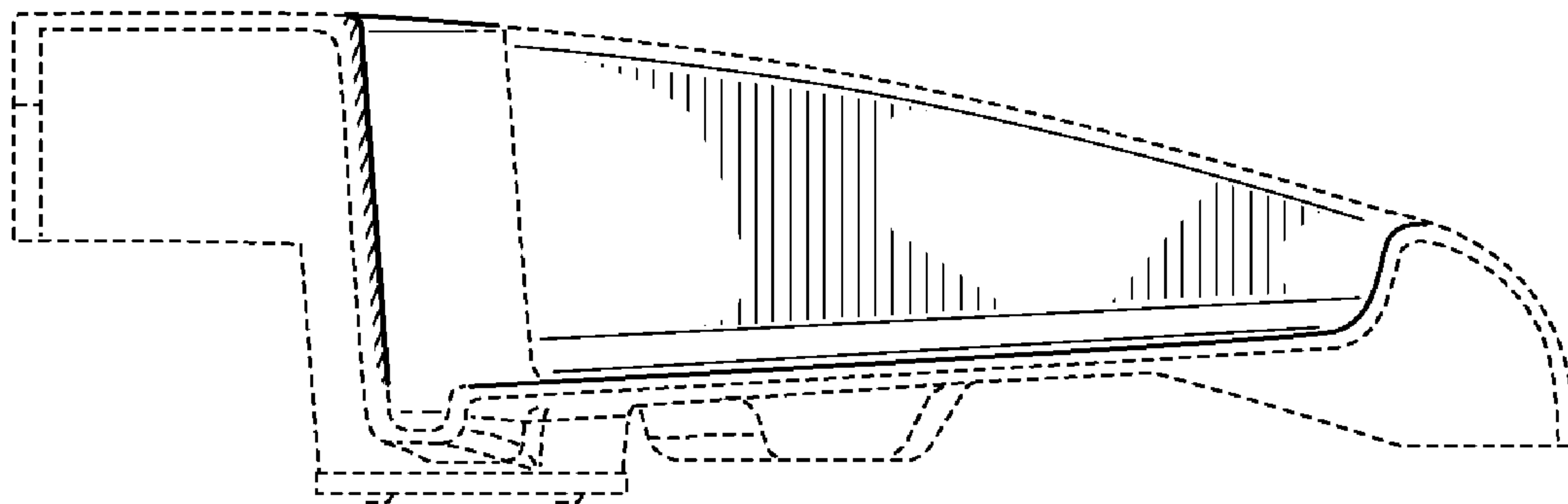

FIG. 9