



US00D625706S

(12) **United States Design Patent**
Graber

(10) **Patent No.:** **US D625,706 S**
(45) **Date of Patent:** **** Oct. 19, 2010**

(54) **HOUSING FOR PUBLIC ADDRESS SYSTEM**

(57) **CLAIM**

(76) **Inventor:** **Curtis E. Graber**, 9301 Roberts Rd.,
Woodburn, IN (US) 46797

The ornamental design for a housing for a public address system, as shown.

(**) **Term:** **14 Years**

DESCRIPTION

(21) **Appl. No.:** **29/349,994**

FIG. 1 is a front bottom perspective view of a public address system showing my new design;

(22) **Filed:** **May 25, 2010**

FIG. 2 is rear elevational view thereof;

(51) **LOC (9) Cl.** **14-01**

FIG. 3 is a top plan view thereof;

(52) **U.S. Cl.** **D14/212**

FIG. 4 is a front top perspective view of a second embodiment of FIG. 1;

(58) **Field of Classification Search** D14/204,
D14/210–216, 172; 181/143–144, 147–148,
181/150–153, 157, 198–199; 381/300–303,
381/306, 332–333, 336, 345, 361–364, 386–388
See application file for complete search history.

FIG. 5 is a rear elevational view thereof;

FIG. 6 is a bottom plan view thereof;

(56) **References Cited**

U.S. PATENT DOCUMENTS

D227,051 S *	6/1973	Snyder	D6/301
D403,680 S *	1/1999	Gremchuck	D14/212
D473,541 S *	4/2003	Lloyd, Jr.	D14/211
D521,979 S *	5/2006	Ishibashi	D14/211
D550,203 S *	9/2007	Thomas	D14/212

FIG. 7 is a front bottom perspective view of a third embodiment of FIG. 1;

FIG. 8 is a rear elevational view thereof;

FIG. 9 is a top plan view thereof;

FIG. 10 is a front bottom perspective view of a fourth embodiment of FIG. 1;

FIG. 11 is a rear elevational view thereof;

FIG. 12 is a top plan view thereof;

FIG. 13 is a front bottom perspective view of a fifth embodiment of FIG. 1;

FIG. 14 is a rear elevational view thereof; and,

FIG. 15 is a top plan view thereof.

* cited by examiner

Primary Examiner—Nanda Bondade

(74) *Attorney, Agent, or Firm*—Paul W. O'Malley

1 Claim, 15 Drawing Sheets

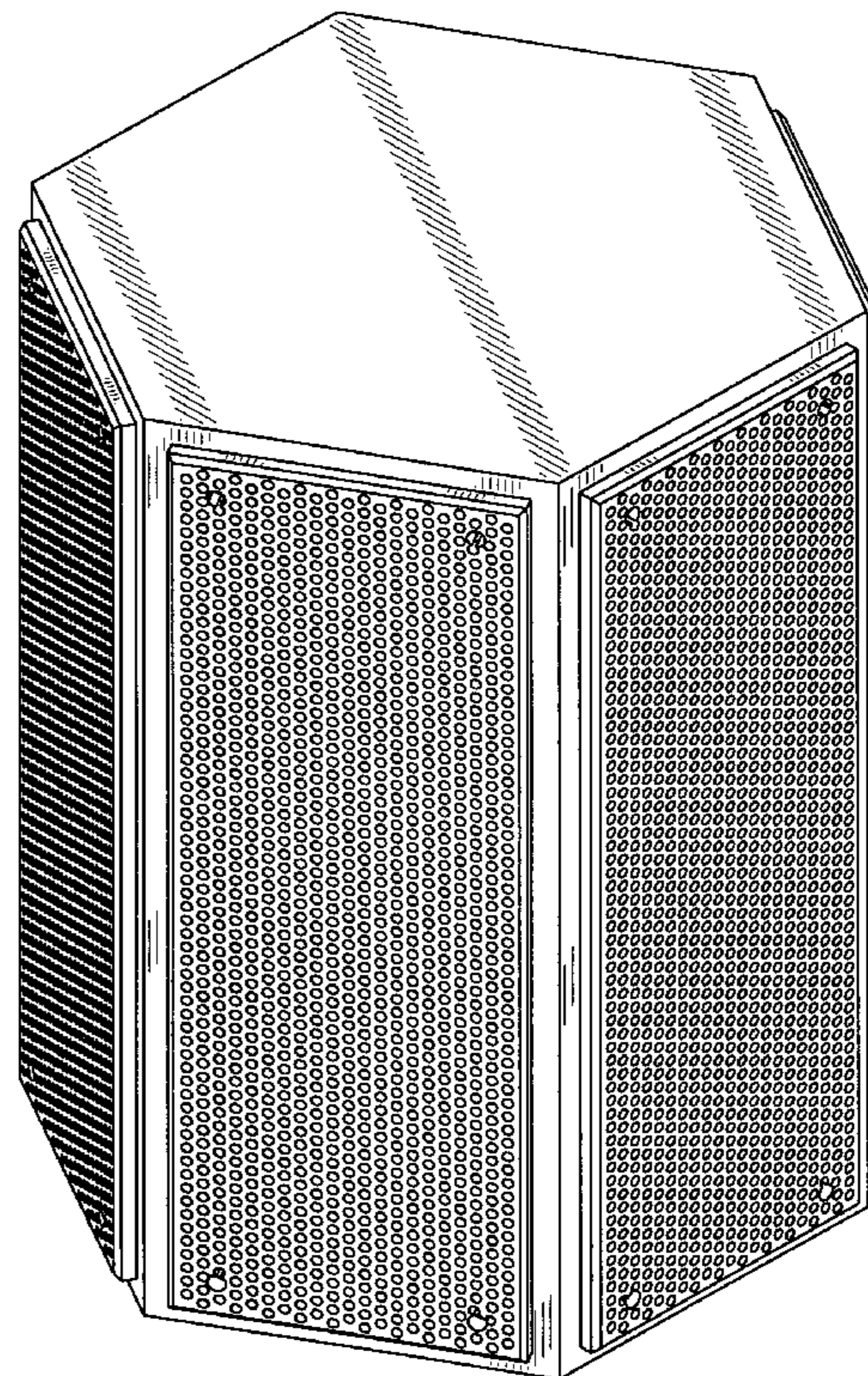
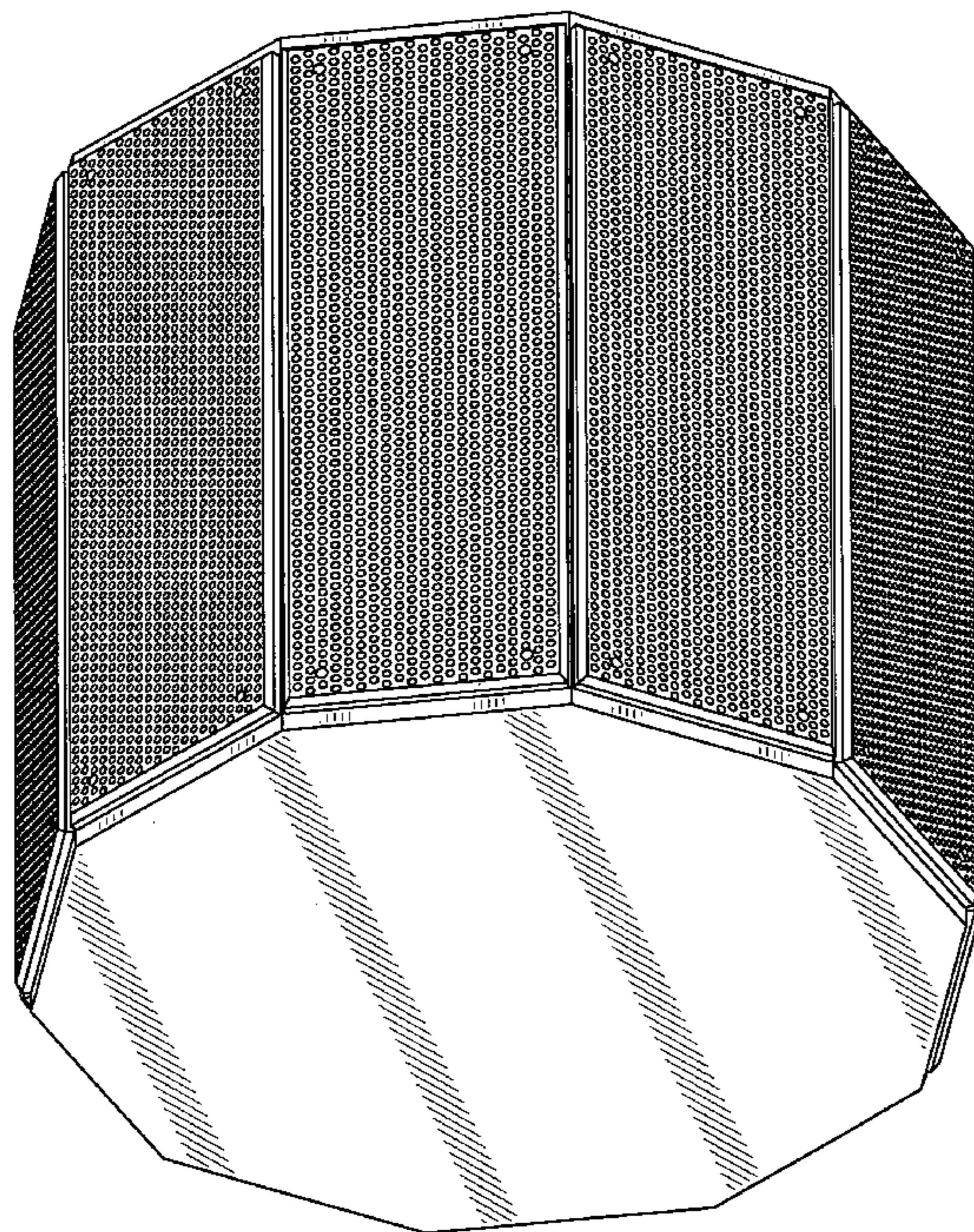

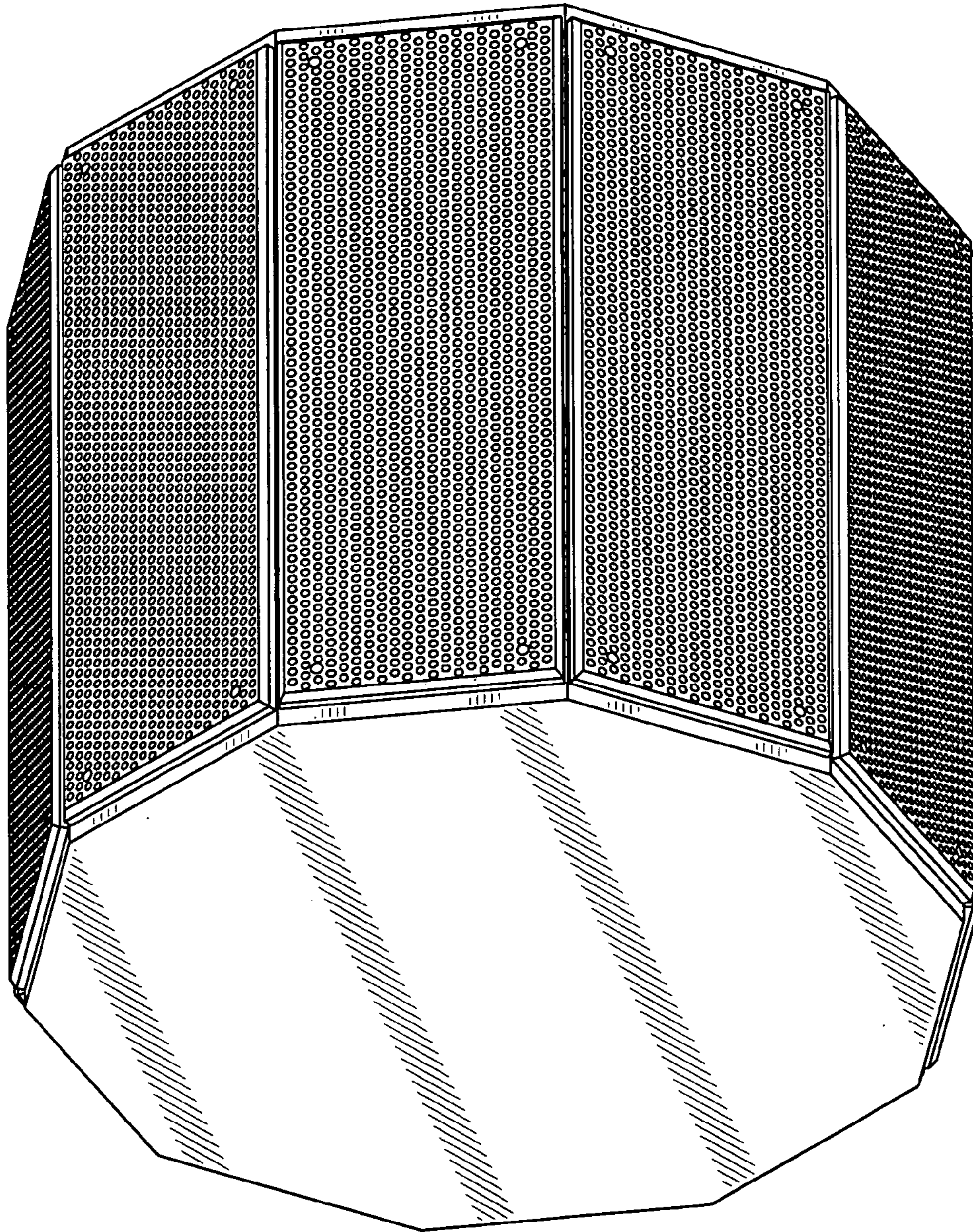

FIG. 1

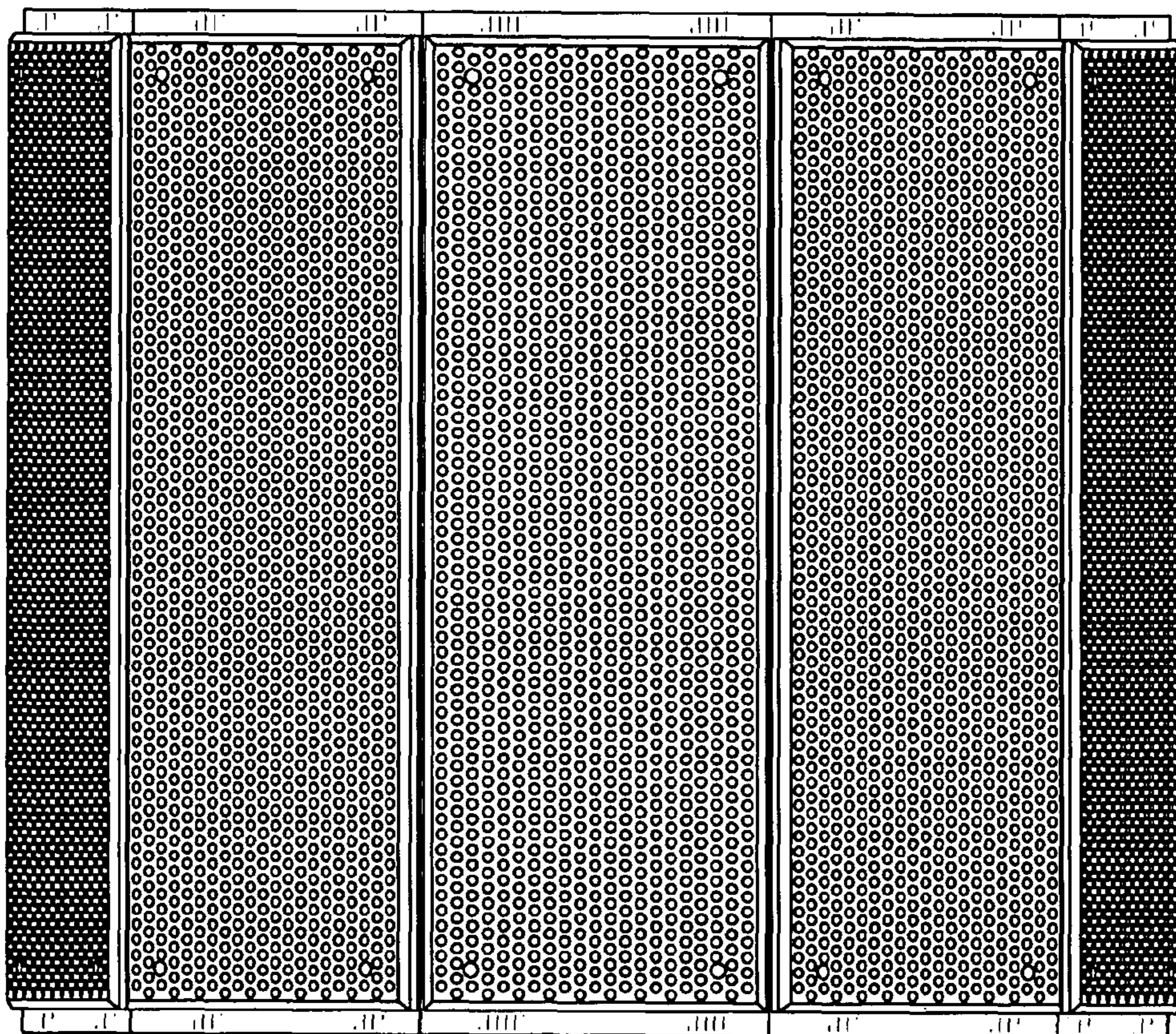

FIG. 2

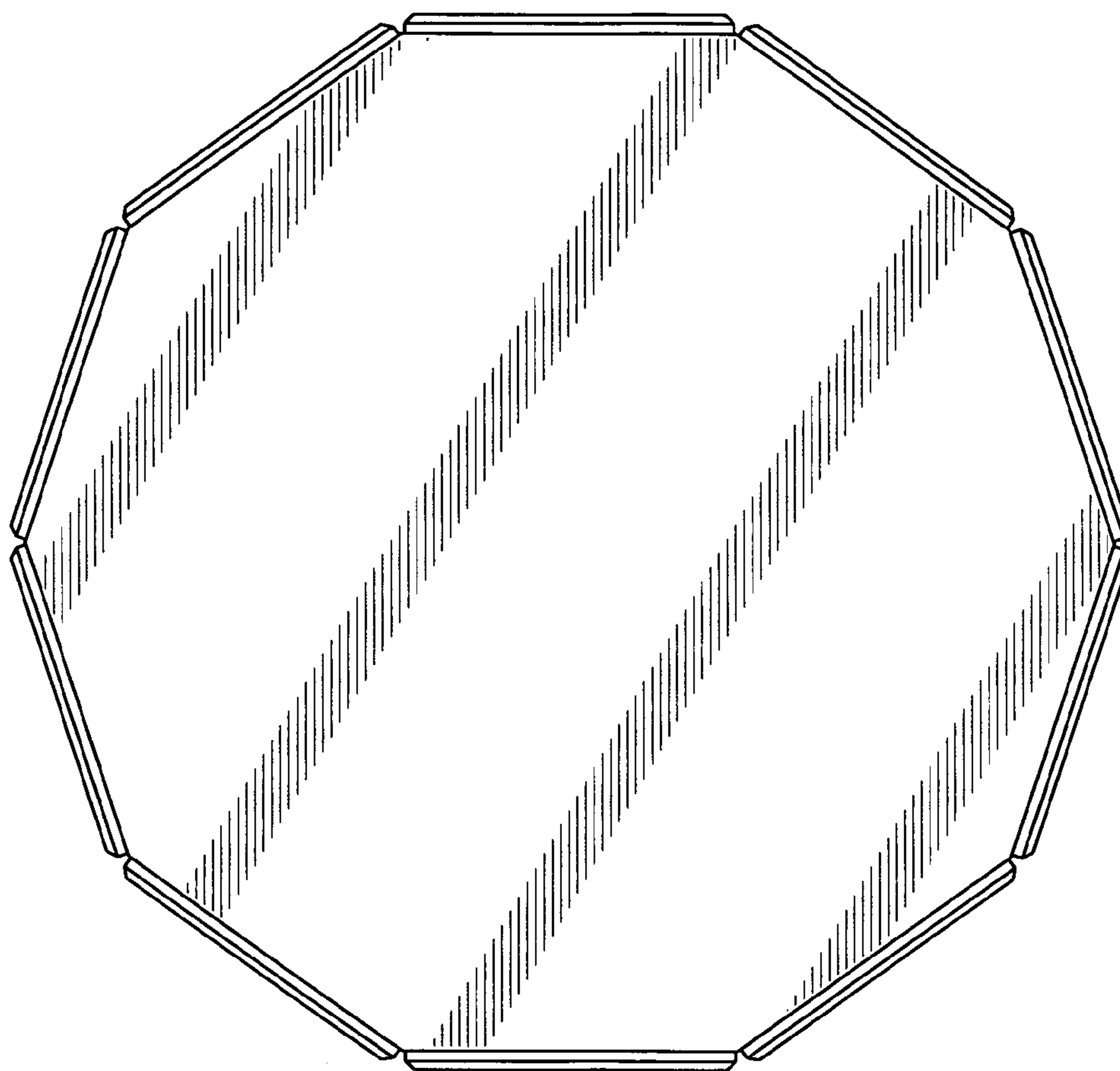

FIG. 3

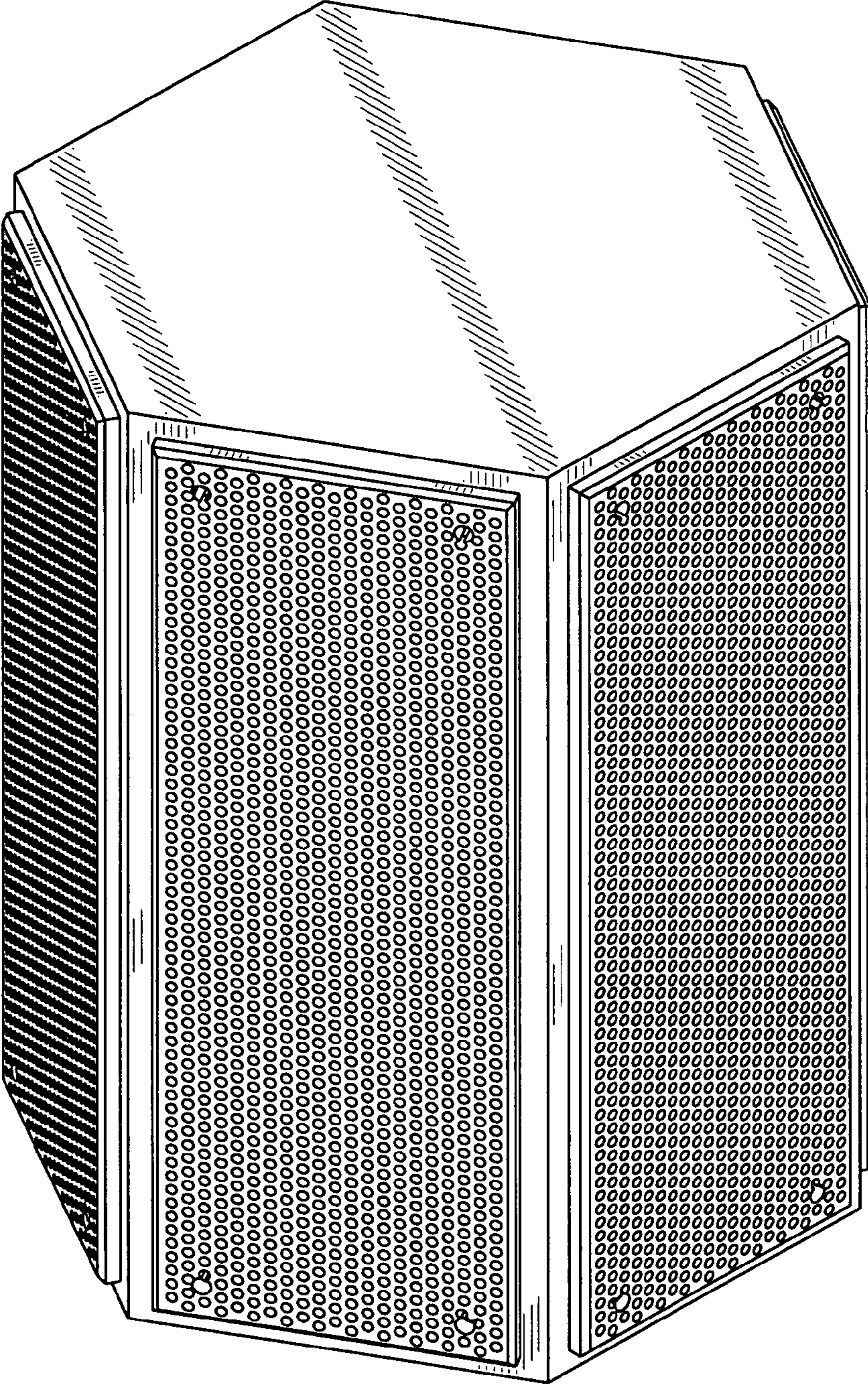

FIG. 4

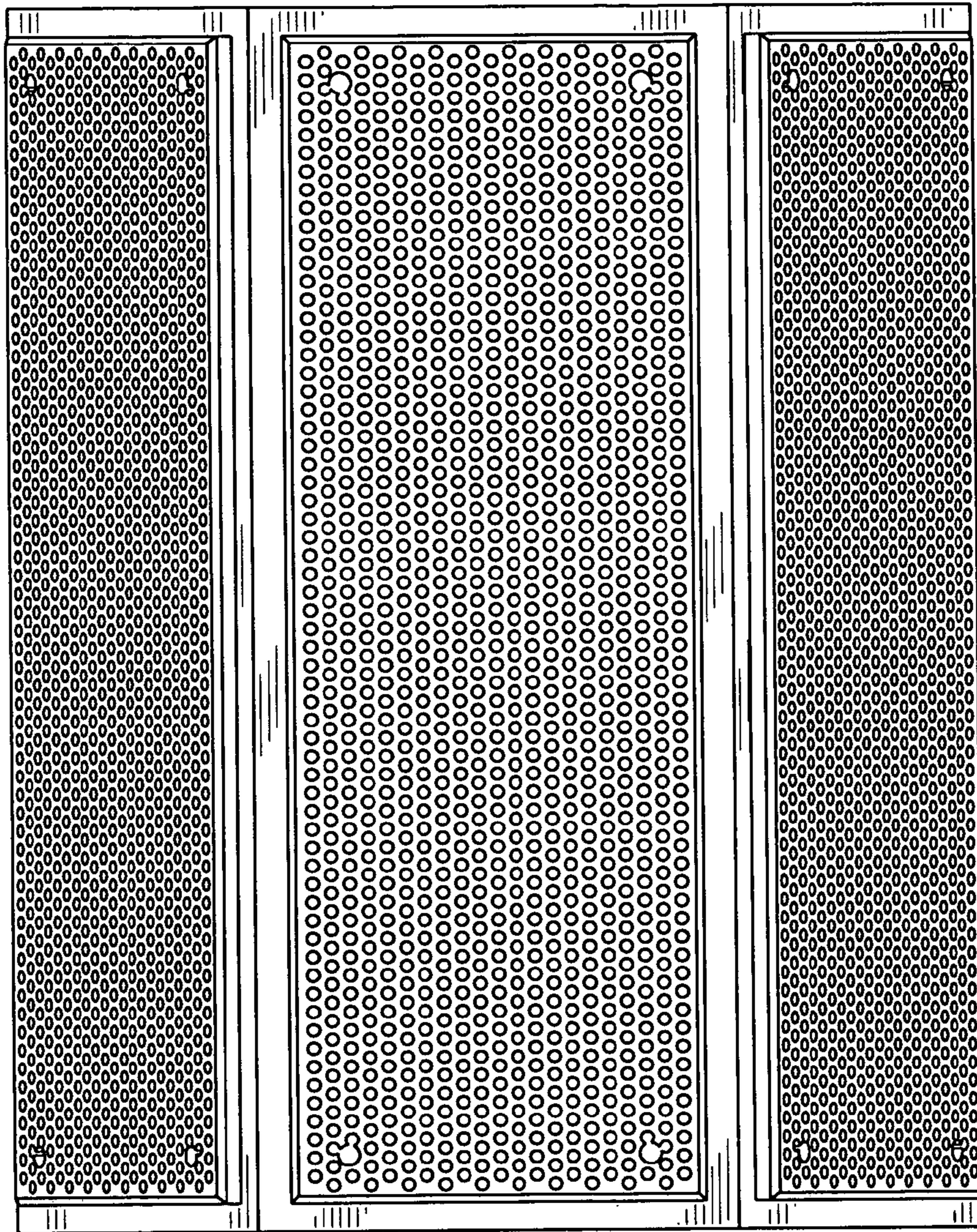

FIG. 5

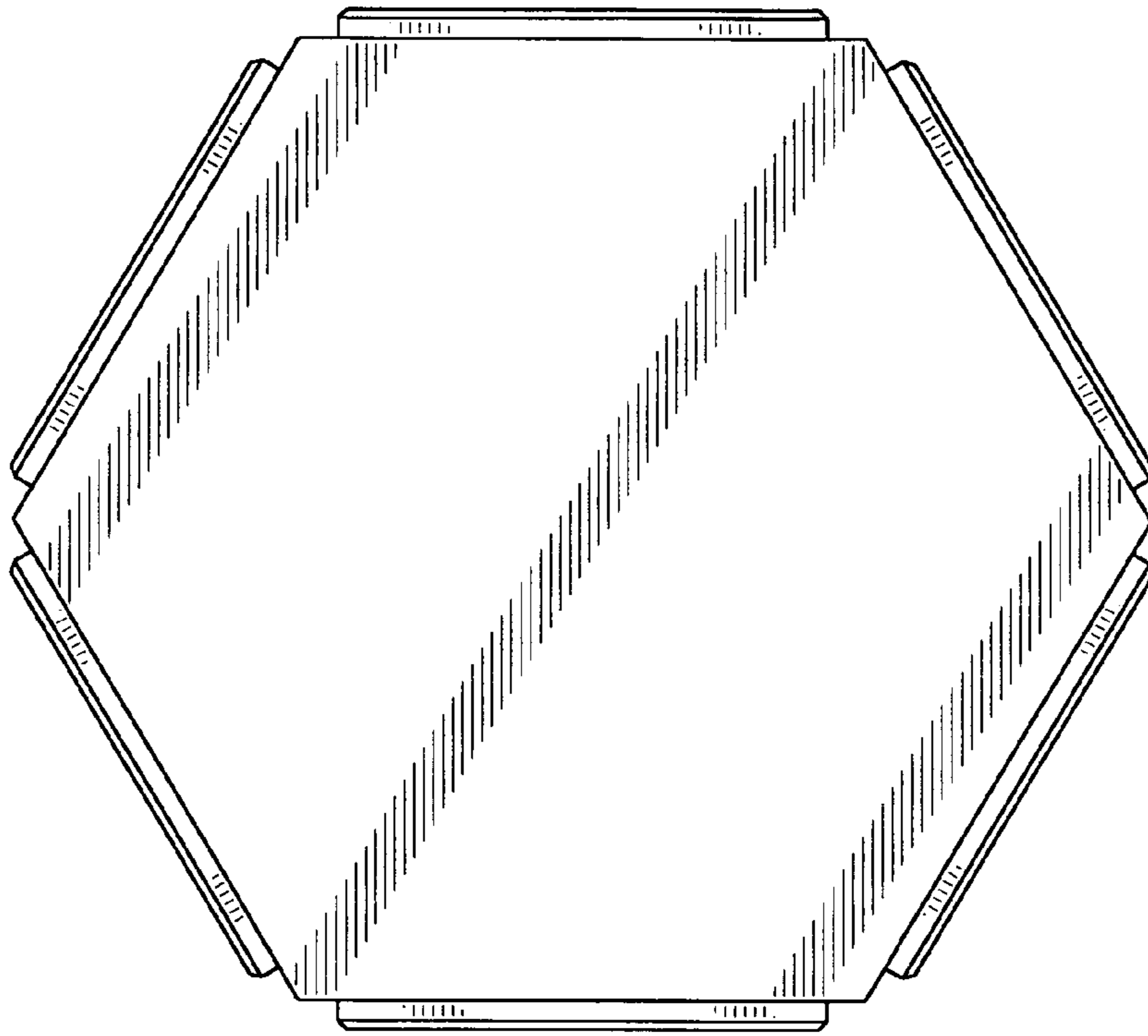

FIG. 6

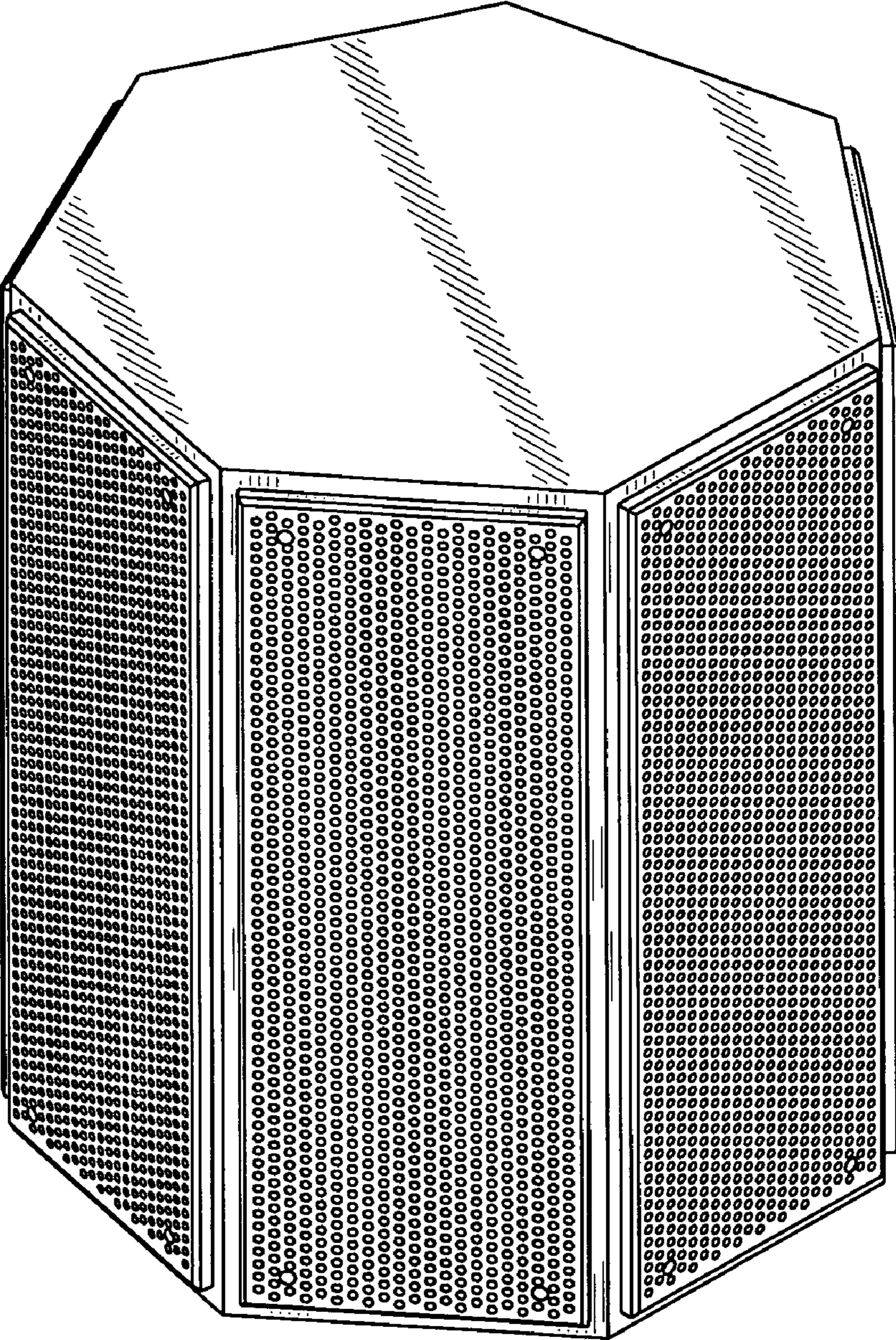

FIG. 7

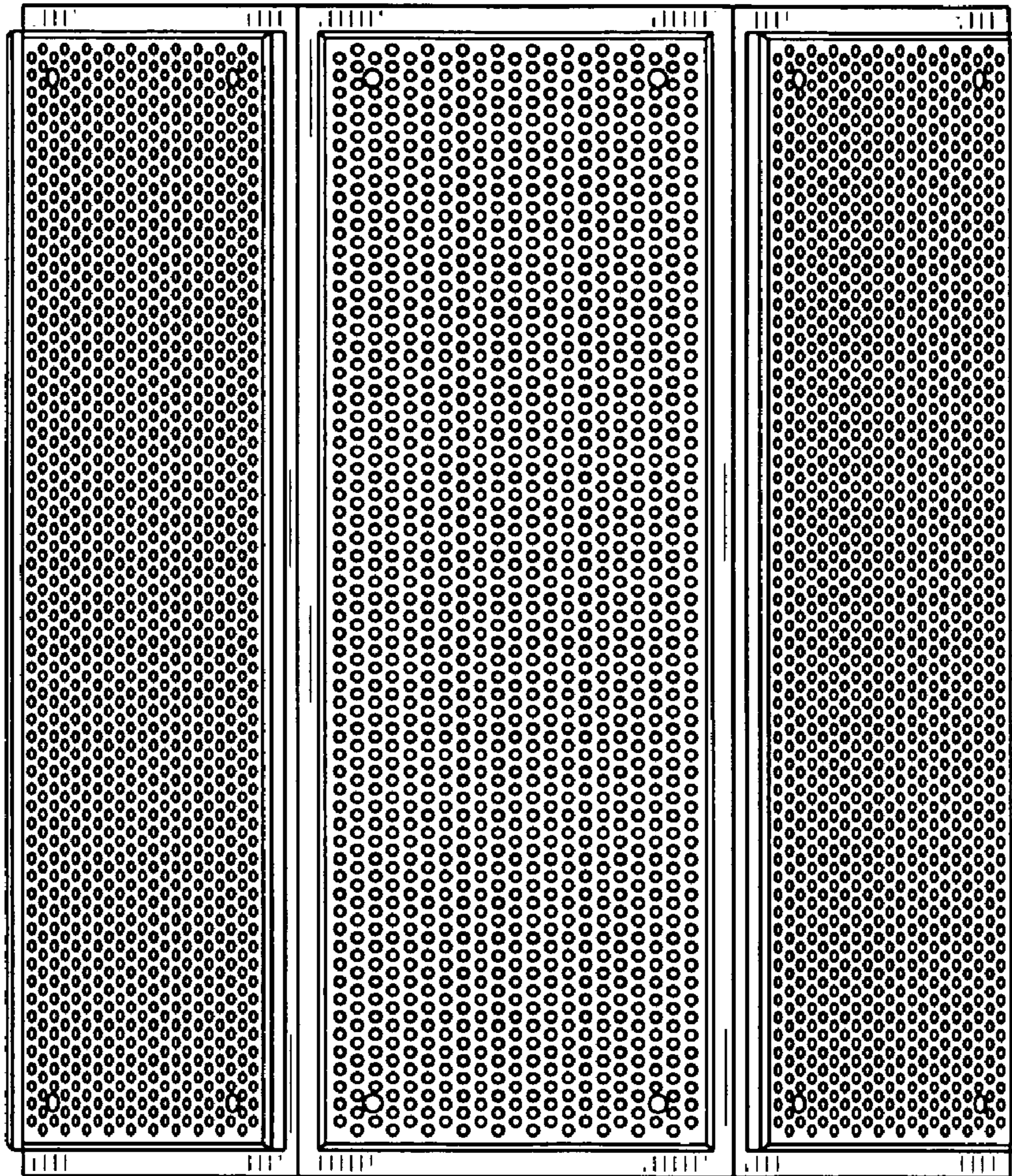

FIG. 8

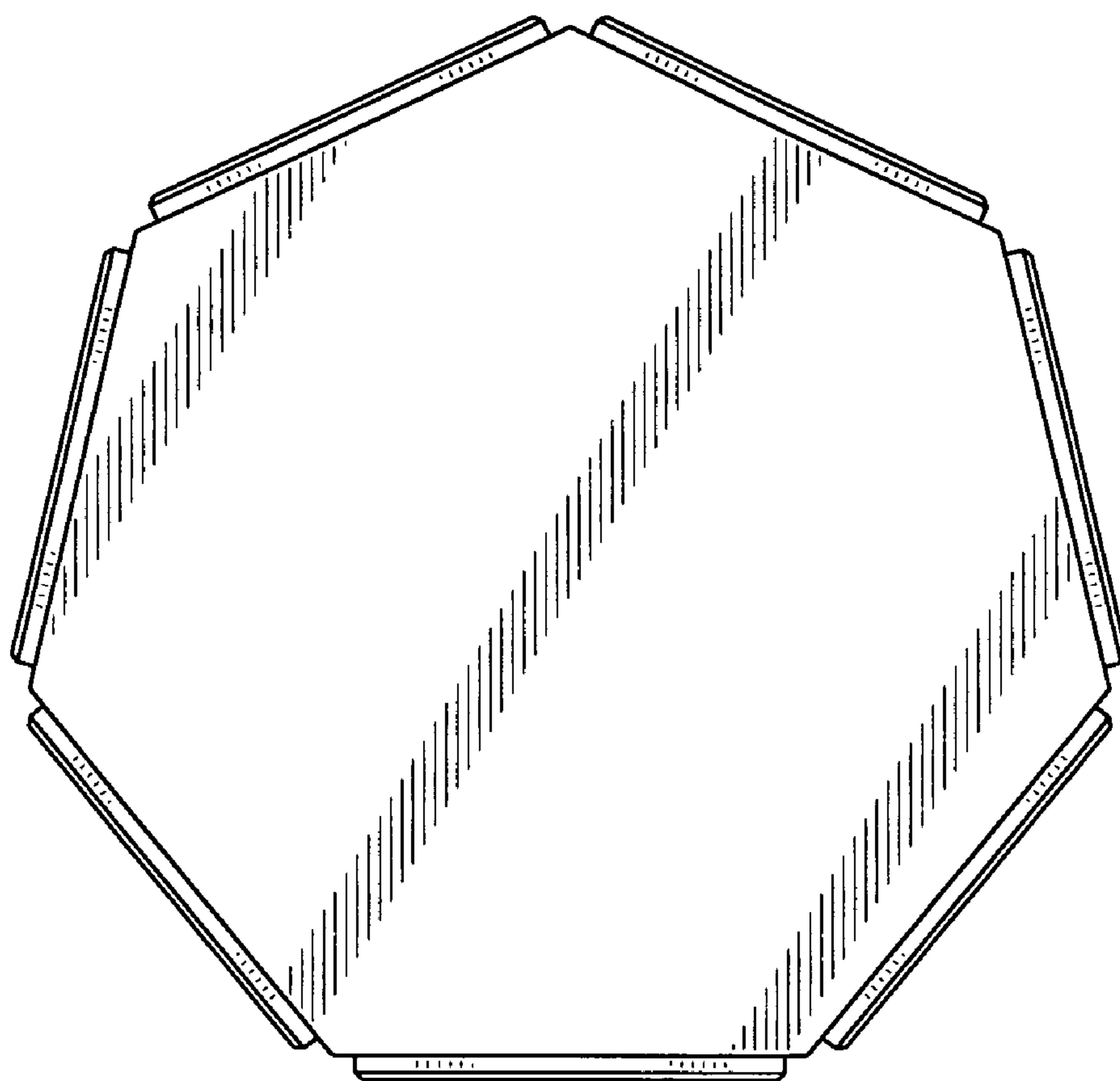

FIG. 9

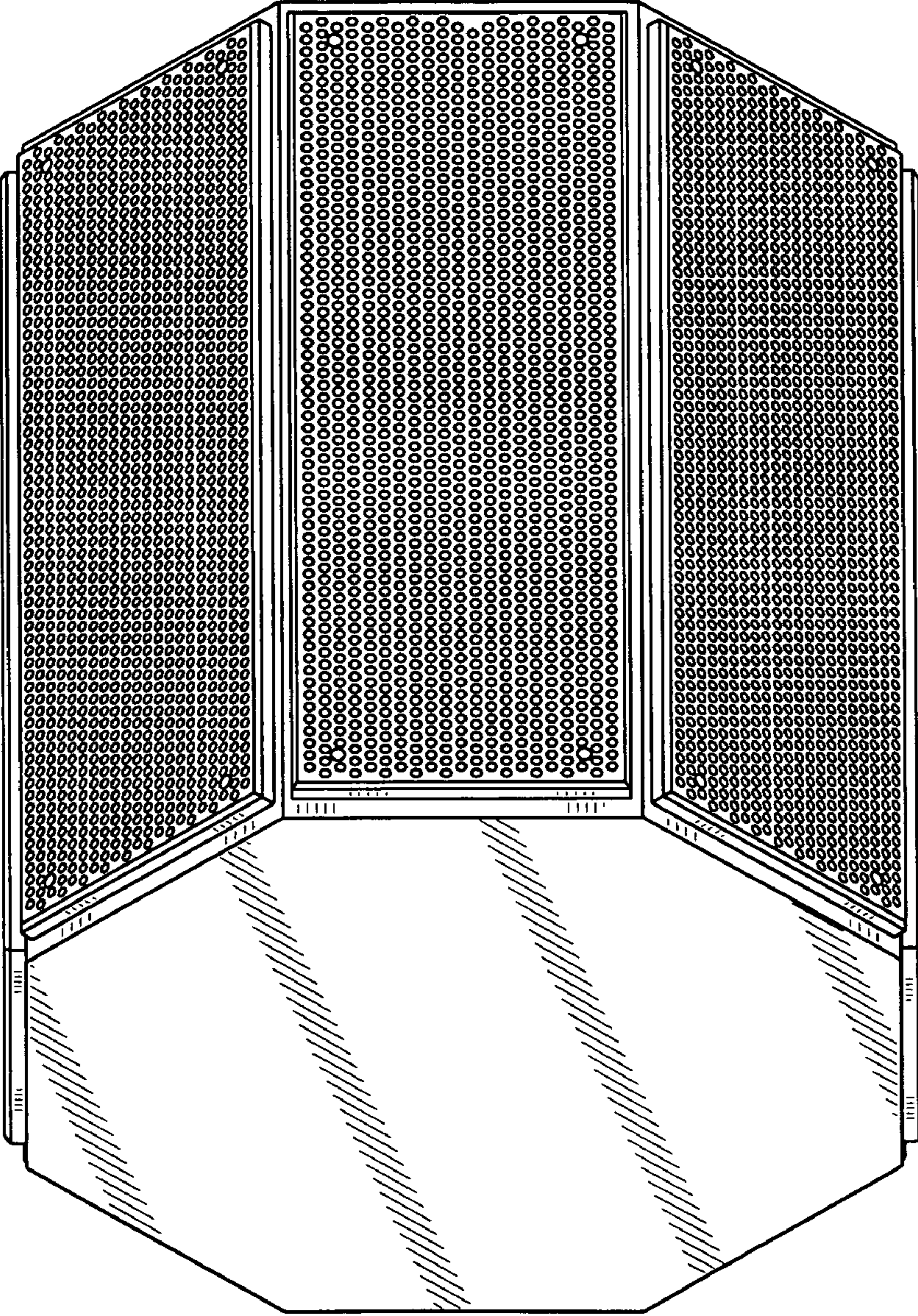

FIG. 10

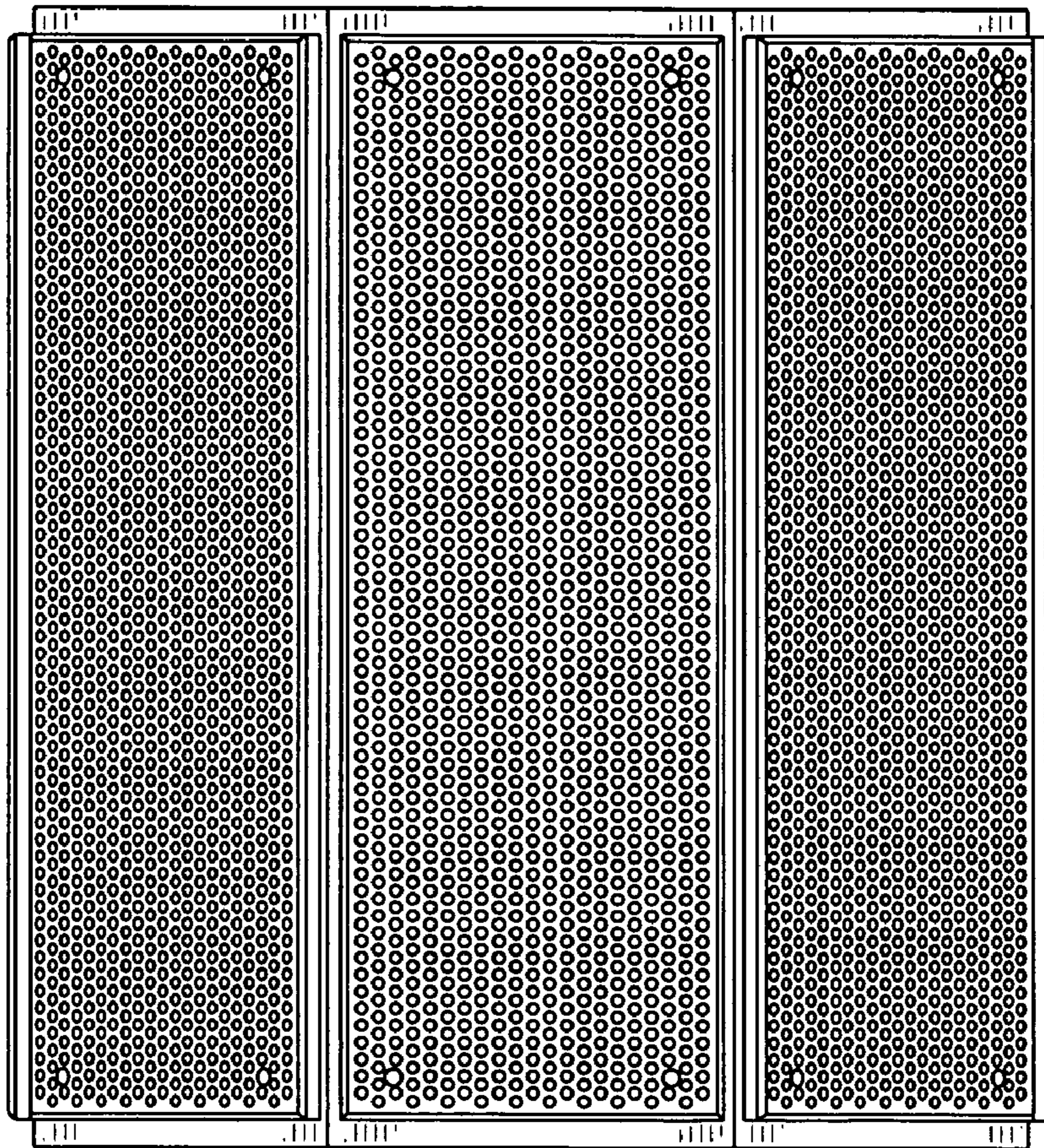

FIG. 11

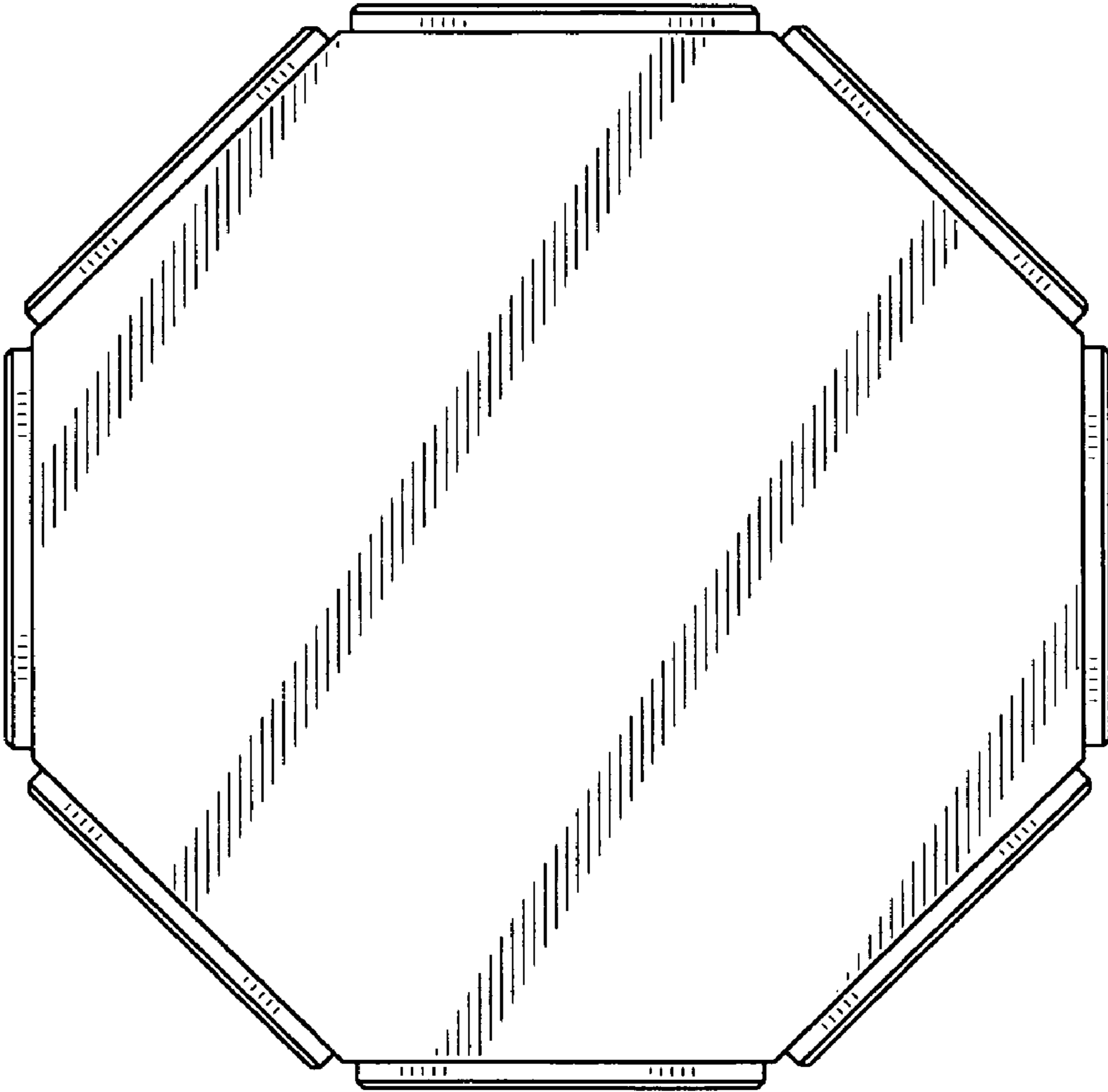

FIG. 12

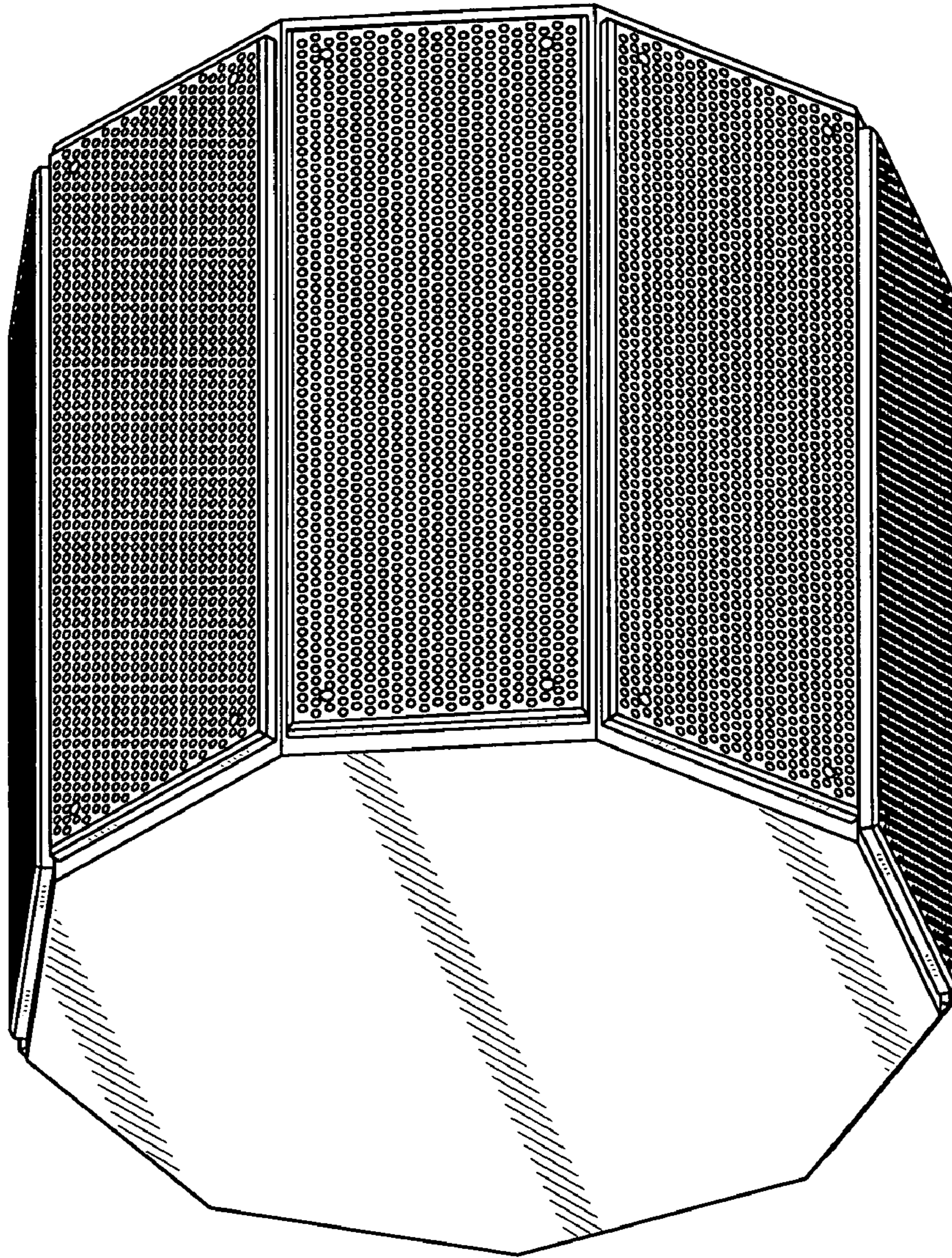

FIG. 13

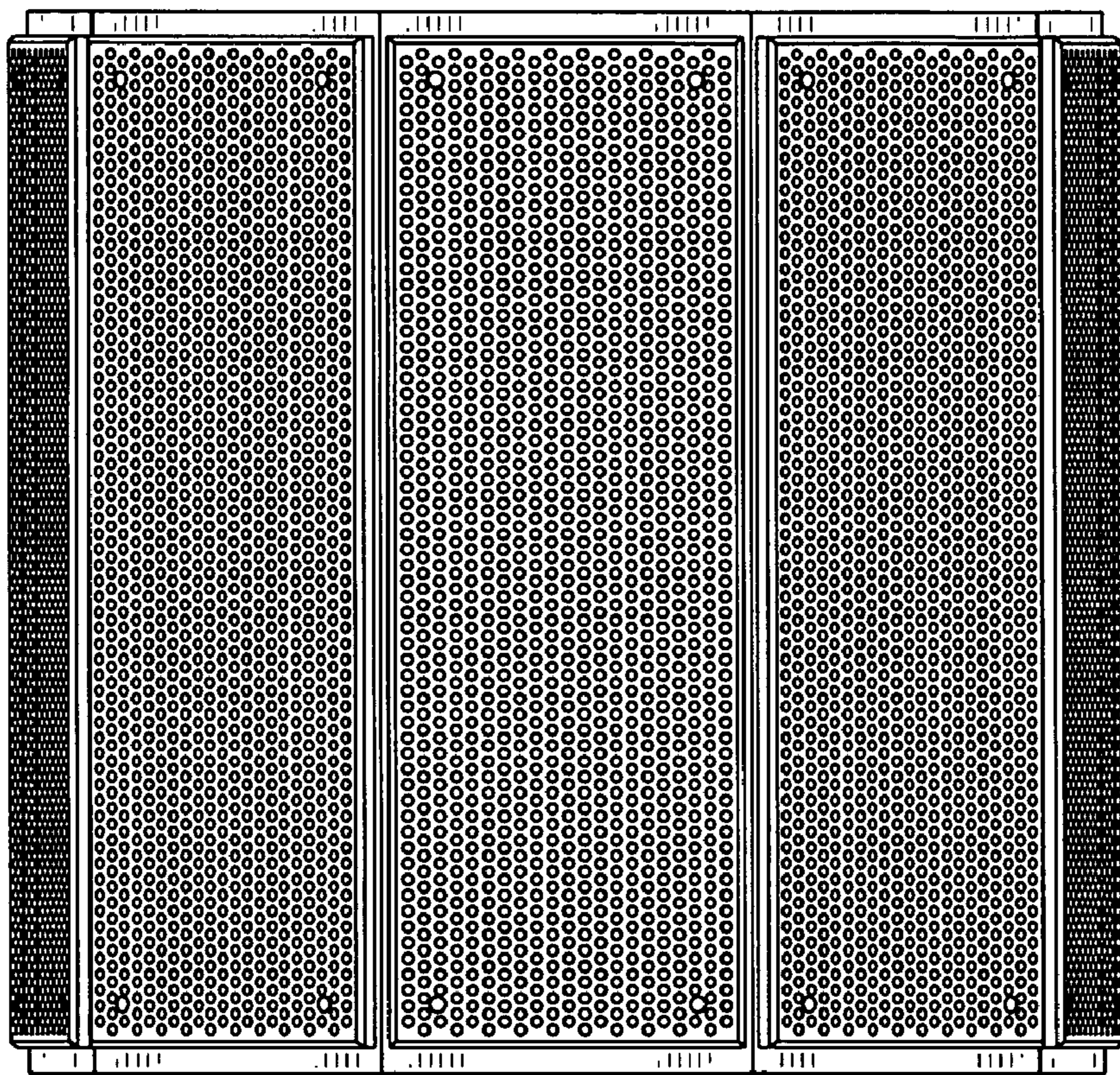

FIG. 14

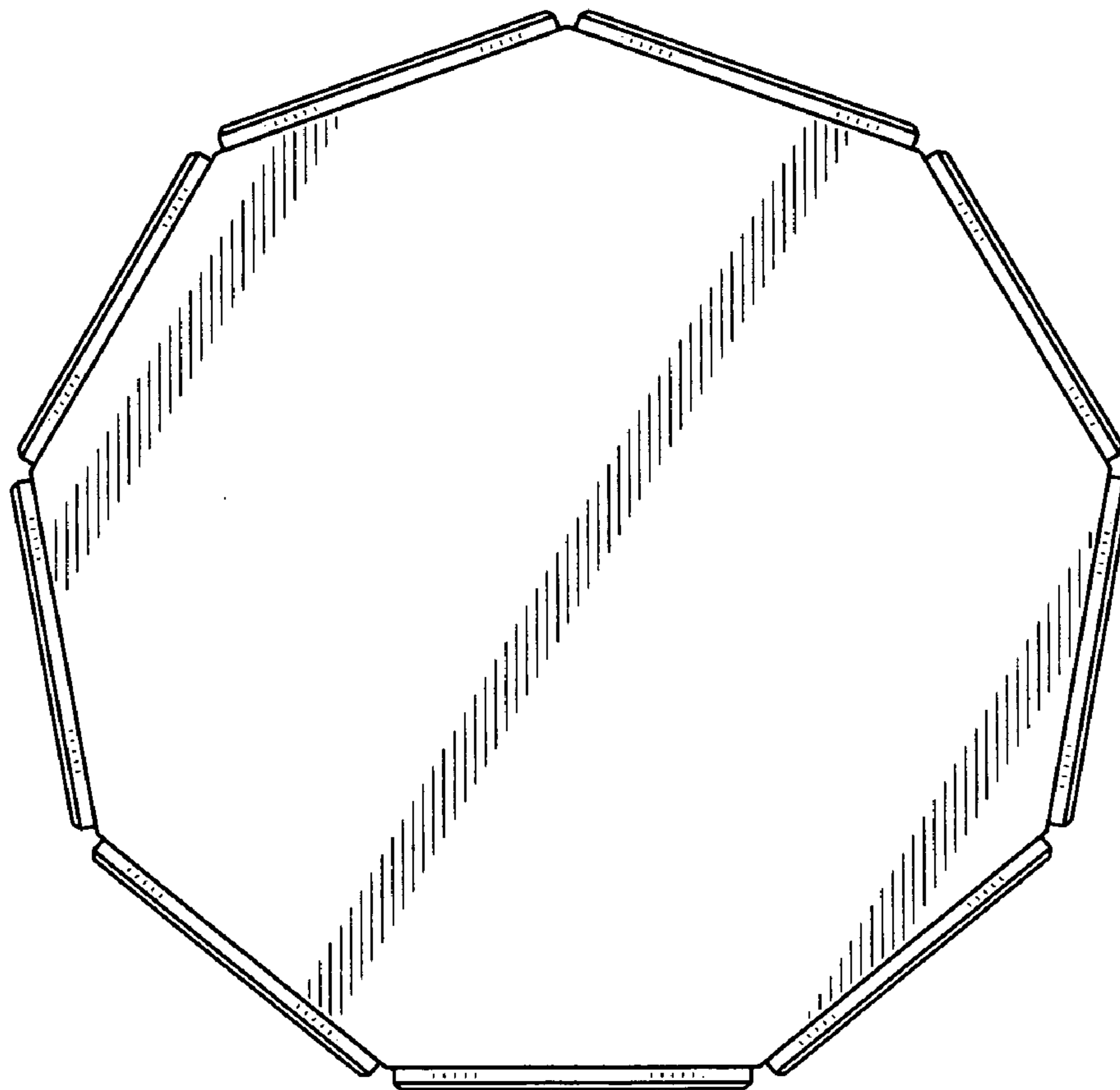

FIG. 15