

US00D625649S

(12) **United States Design Patent**
Rooney

(10) **Patent No.:** **US D625,649 S**
(45) **Date of Patent:** **** Oct. 19, 2010**

(54) **BOX VASE**

D390,498 S * 2/1998 Reichert D11/144
5,771,614 A 6/1998 Dawson
5,836,095 A 11/1998 Crowell
D406,058 S * 2/1999 Allmon D9/433

(75) Inventor: **Maria D. Rooney**, Auburn, NH (US)

(73) Assignee: **Blooms In A Box, LLC**, Auburn, NH (US)

(Continued)

(**) Term: **14 Years**

FOREIGN PATENT DOCUMENTS

(21) Appl. No.: **29/322,766**

GB D 2097710 * 11/2000

(22) Filed: **Aug. 12, 2008**

OTHER PUBLICATIONS

(51) **LOC (9) Cl.** **11-02**

(52) **U.S. Cl.** **D11/146; D9/431**

(58) **Field of Classification Search** D6/403–405,
D6/556; D8/1; D9/414, 430–433; D11/143–156;
D19/77, 81, 84; D26/9, 16, 19; D34/1–11;
47/32.7, 33, 39, 41.01, 41.1, 41.11–41.15,
47/44–47, 65.5, 65.9, 66.1, 66.6, 66.7, 67–71
See application file for complete search history.

New Hampshire Union Leader, Sunday News, Apr. 27, 2003, Home and Family Section “Flower-topped box”.

(Continued)

Primary Examiner—Garth Rademaker
(74) *Attorney, Agent, or Firm*—McLane, Graf, Raulerson & Middleton, Professional Association

(56) **References Cited**

(57) **CLAIM**

U.S. PATENT DOCUMENTS

The ornamental design for a box vase, as shown and described.

- D33,787 S * 12/1900 Meiners D8/1
- 1,518,207 A 12/1924 McCauley
- 1,885,879 A 11/1932 Whittington
- D120,555 S * 5/1940 Pope D9/431
- 2,797,041 A * 6/1957 Rondone 47/84
- D241,407 S * 9/1976 Johnson D34/1
- 4,014,134 A 3/1977 Womack, Jr.
- D249,152 S * 8/1978 Macowski D19/73
- 4,242,835 A 1/1981 Mondragon Sorribes
- 4,584,213 A 4/1986 Rentowl
- D300,521 S * 4/1989 Toltzman D11/155
- 4,819,803 A 4/1989 Neiser
- 4,917,240 A 4/1990 Roberts et al.
- 5,038,930 A 8/1991 Holtkamp, Jr.
- 5,366,192 A 11/1994 Carroll
- 5,435,085 A 7/1995 Johnson
- 5,595,008 A 1/1997 Johnson
- 5,628,396 A 5/1997 Weiner
- D384,002 S * 9/1997 David et al. D11/164
- 5,682,999 A 11/1997 Larson
- 5,706,947 A 1/1998 Hodges

DESCRIPTION

FIG. 1 is front perspective view of a box vase showing my new design;
FIG. 2 is a front elevational view thereof;
FIG. 3 is a rear elevational view thereof;
FIG. 4 is a right-side elevational view thereof, the left-side elevational view being a mirror image thereof;
FIG. 5 is a top plan view thereof;
FIG. 6 is a bottom plan view thereof; and,
FIG. 7 is a cross-sectional view taken along line 7—7 of FIG. 4.

The broken lines depict environmental subject matter only and form no part of the claimed design.

1 Claim, 4 Drawing Sheets

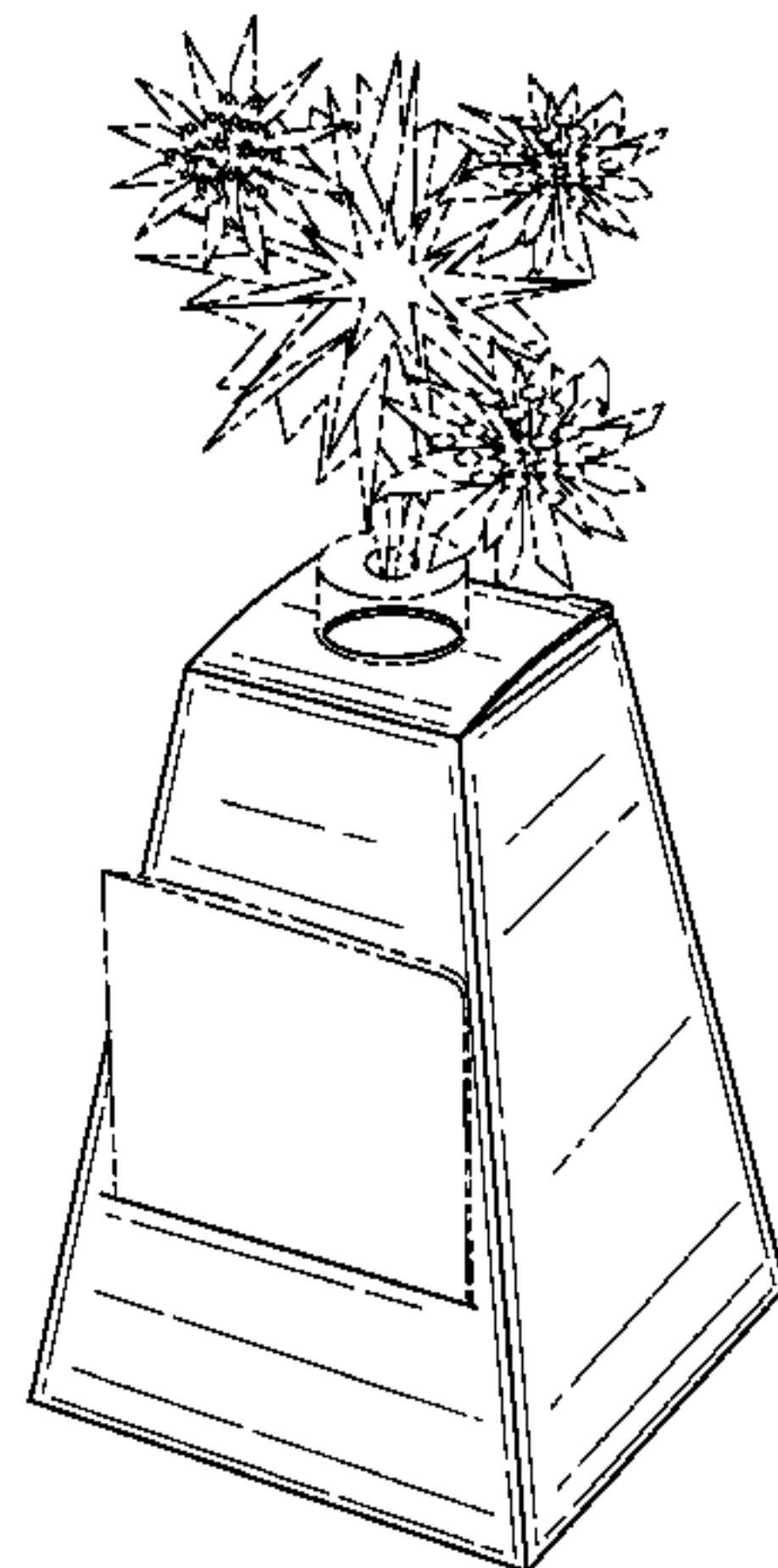

US D625,649 S

Page 2

U.S. PATENT DOCUMENTS

5,878,982 A 3/1999 Cumby et al.
D422,027 S 3/2000 Weiner
6,061,955 A 5/2000 Domstein
6,138,828 A 10/2000 Bendix
6,237,788 B1 5/2001 Shuen
D454,065 S * 3/2002 Bryan et al. D9/430
D456,710 S * 5/2002 Persson D9/431
6,423,740 B1 7/2002 Campbell

D522,404 S * 6/2006 Kerdil D11/143
D572,169 S * 7/2008 De Roeck D11/155
2003/0168369 A1 9/2003 Kroeze et al.
2005/0155902 A1 7/2005 Rooney

OTHER PUBLICATIONS

Real Simple Magazine, Oct. 2002, Solutions Section, "Product of the Month—Pop Art".

* cited by examiner

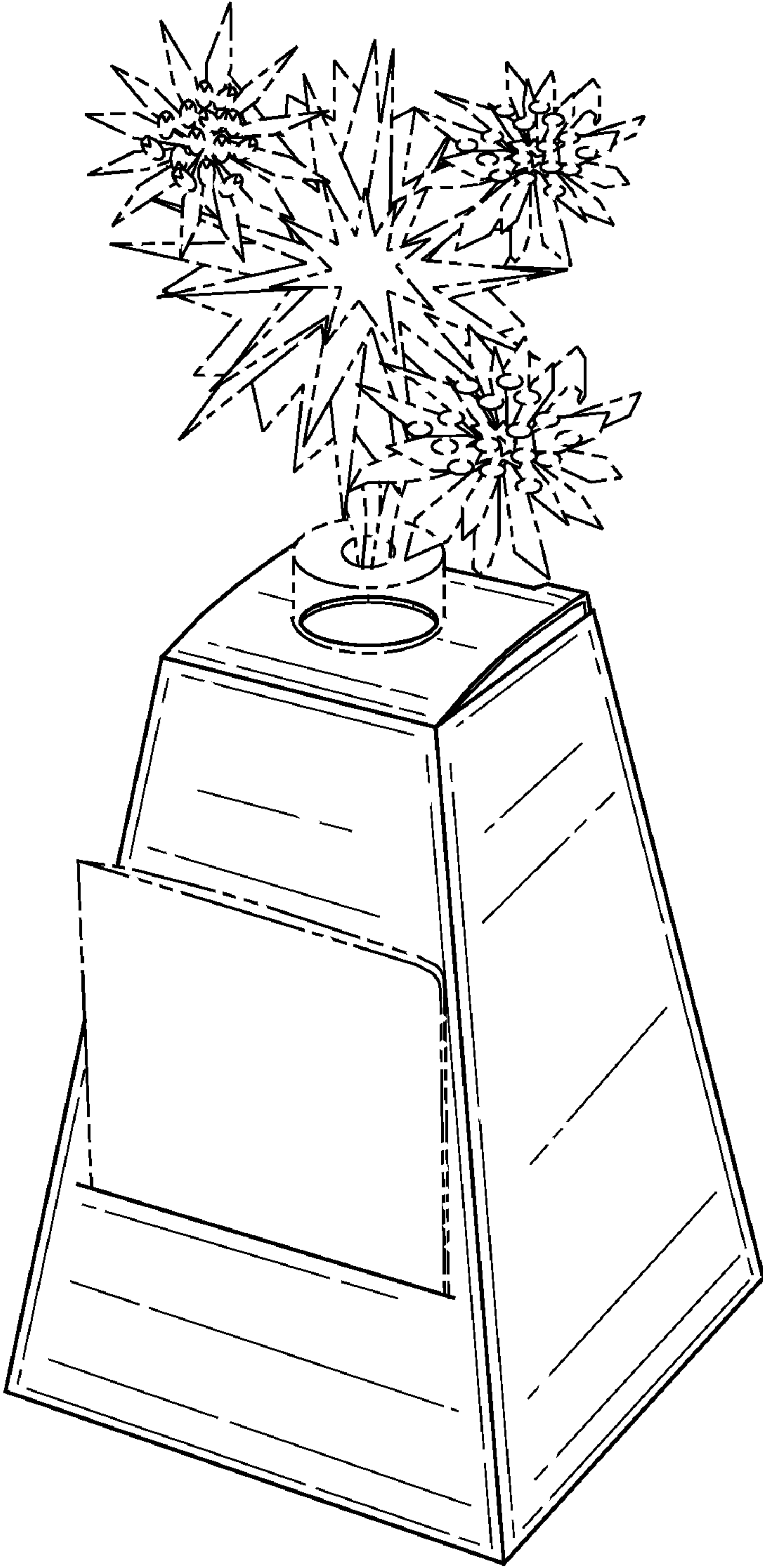

FIG. 1

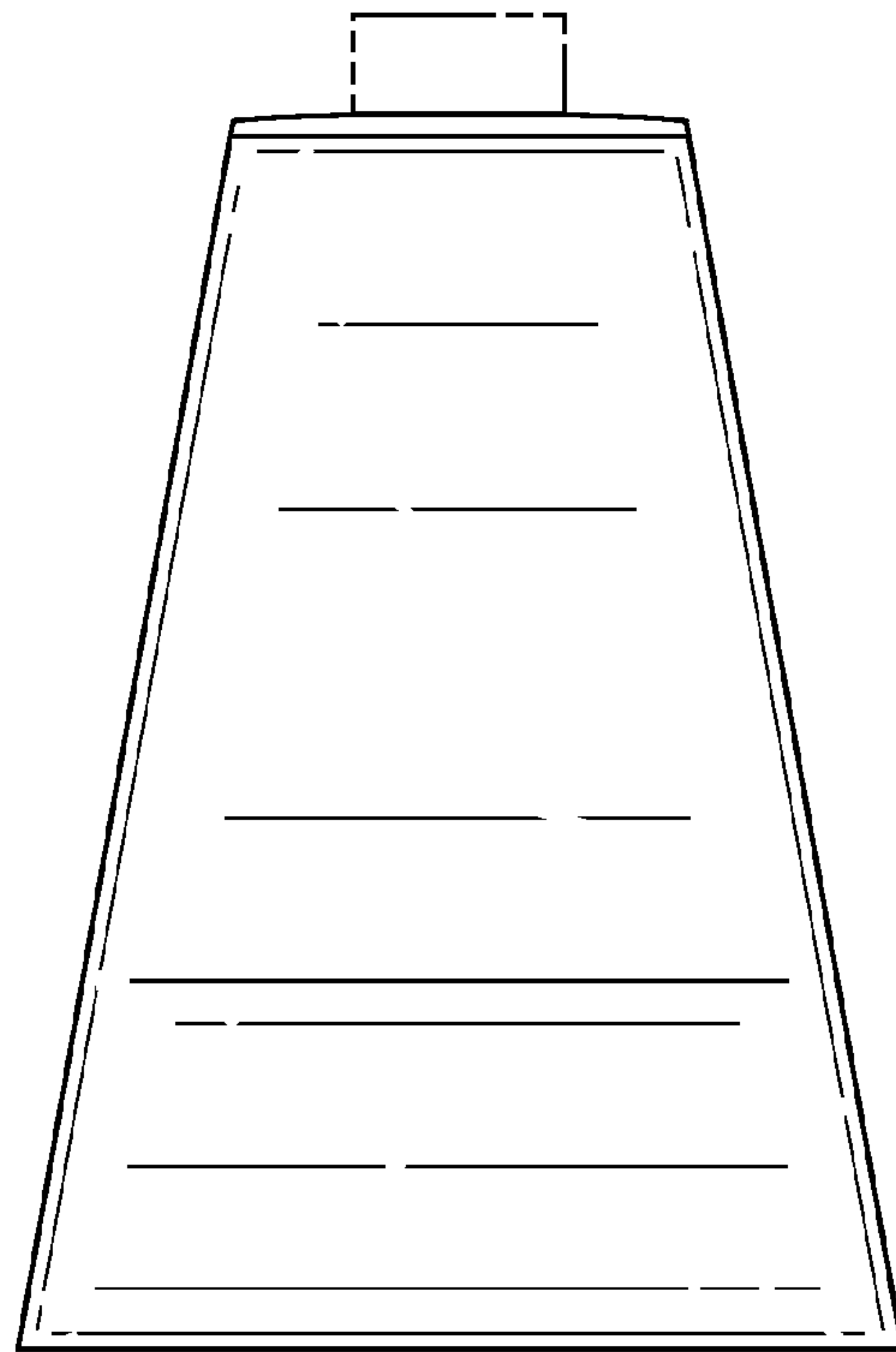

FIG. 2

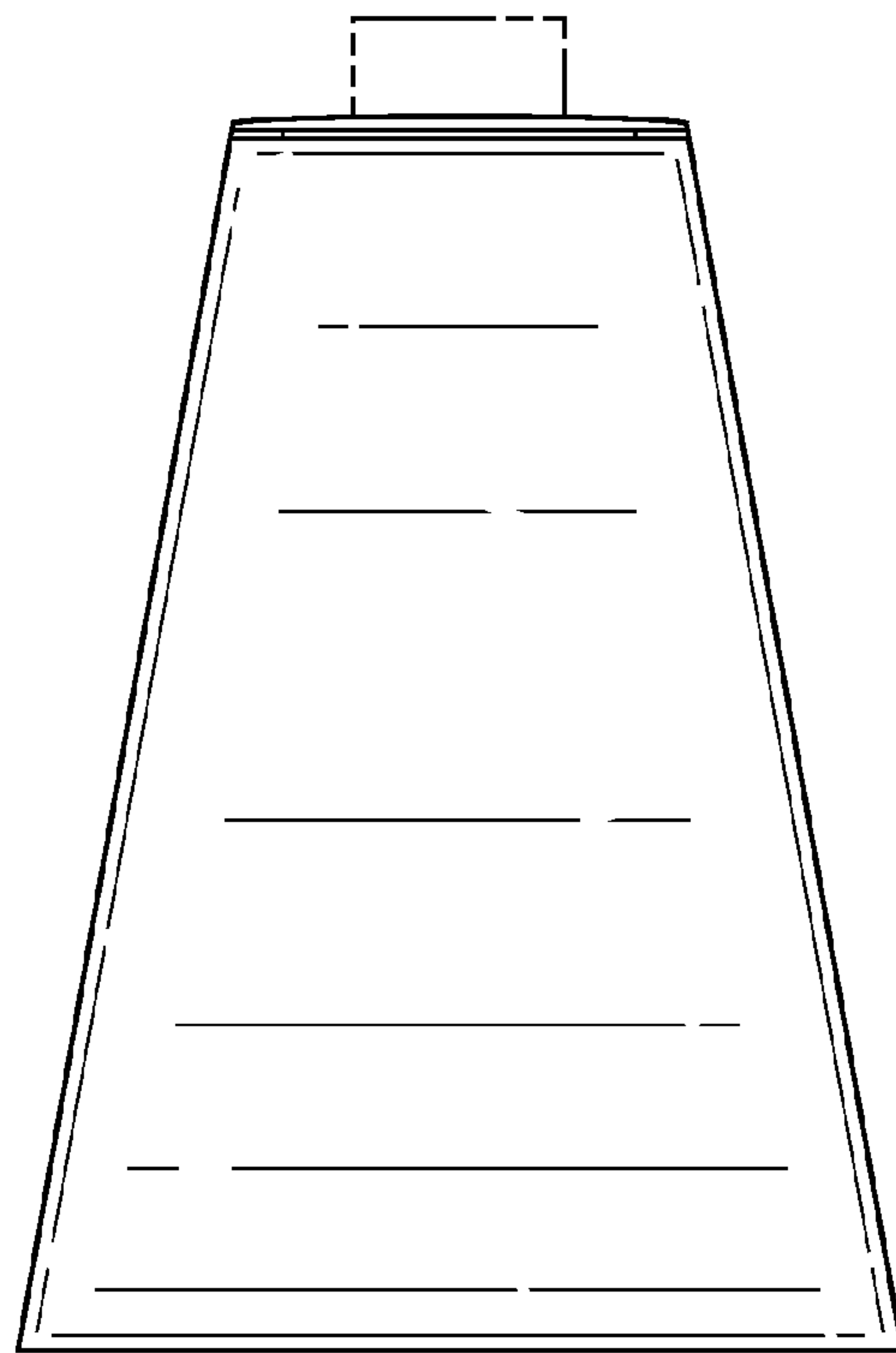

FIG. 3

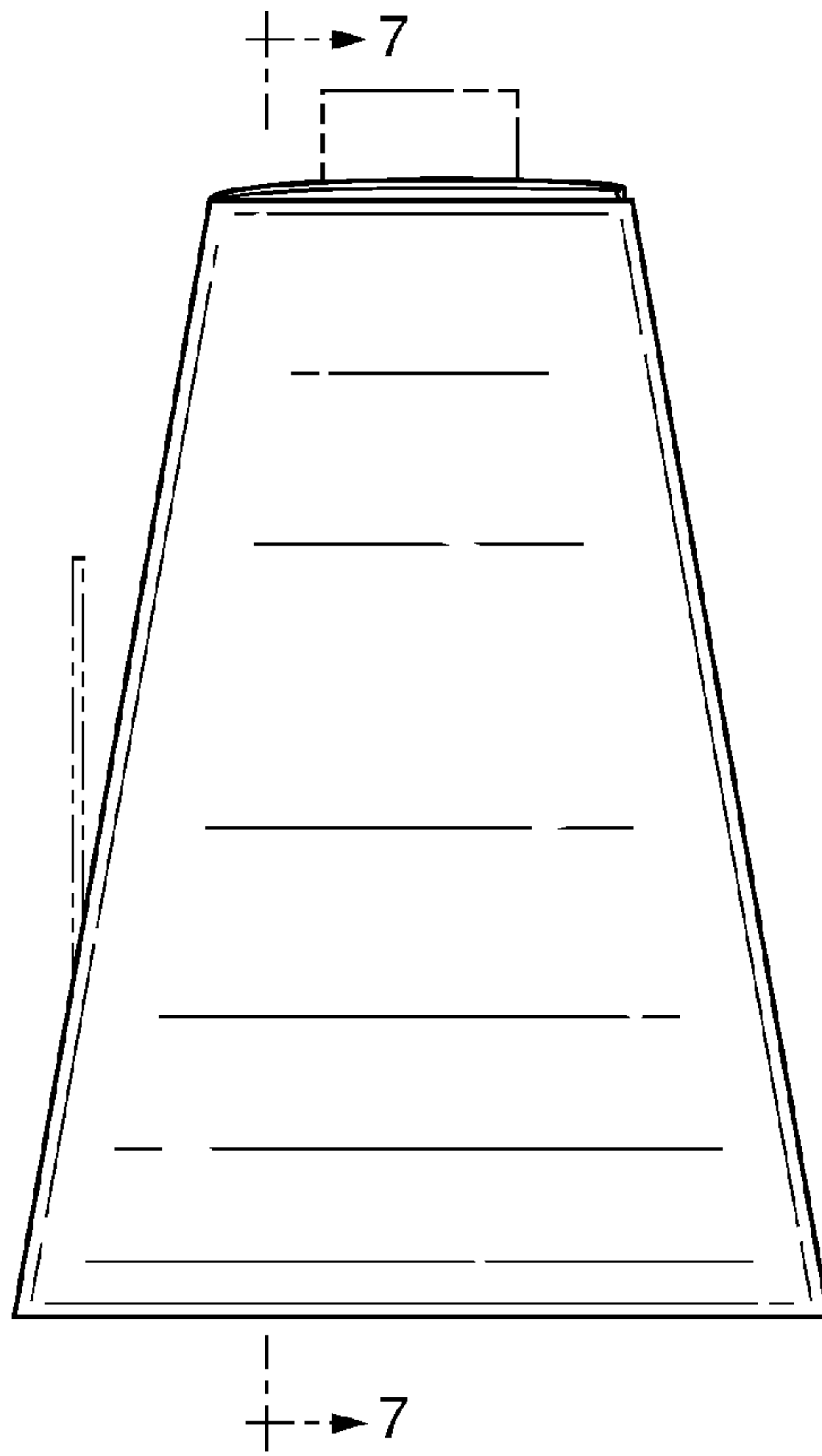

FIG. 4

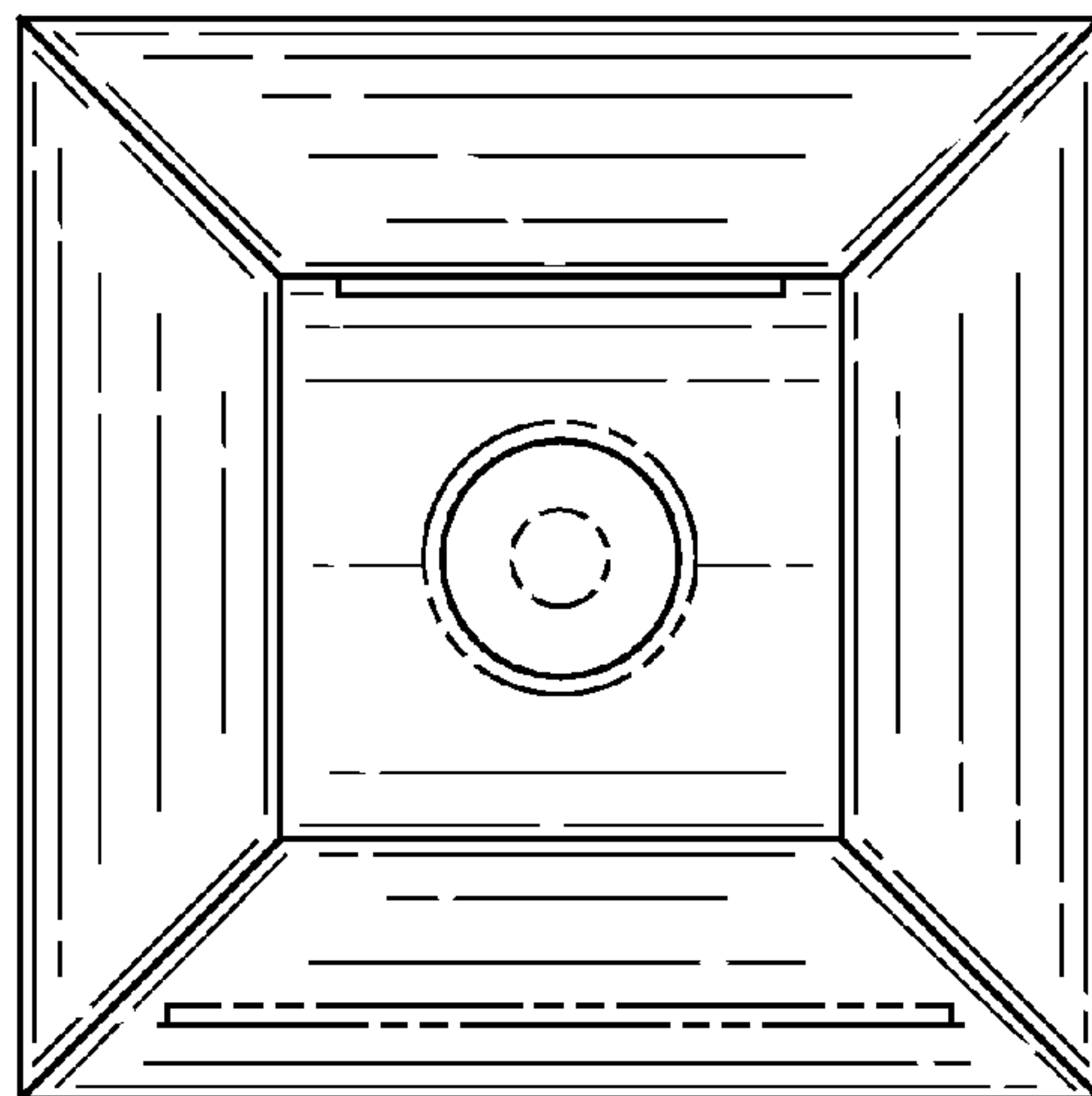

FIG. 5

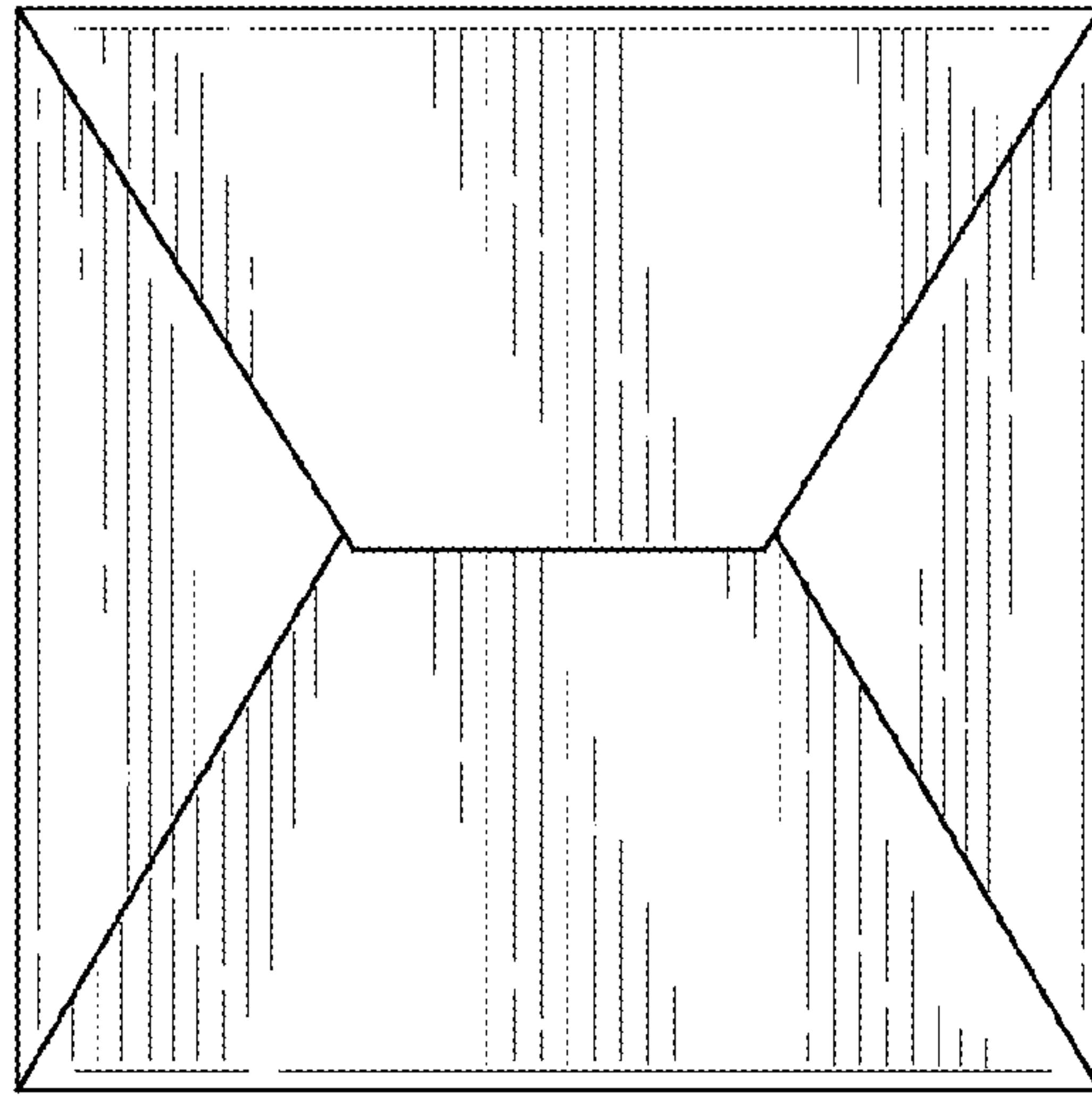

FIG. 6

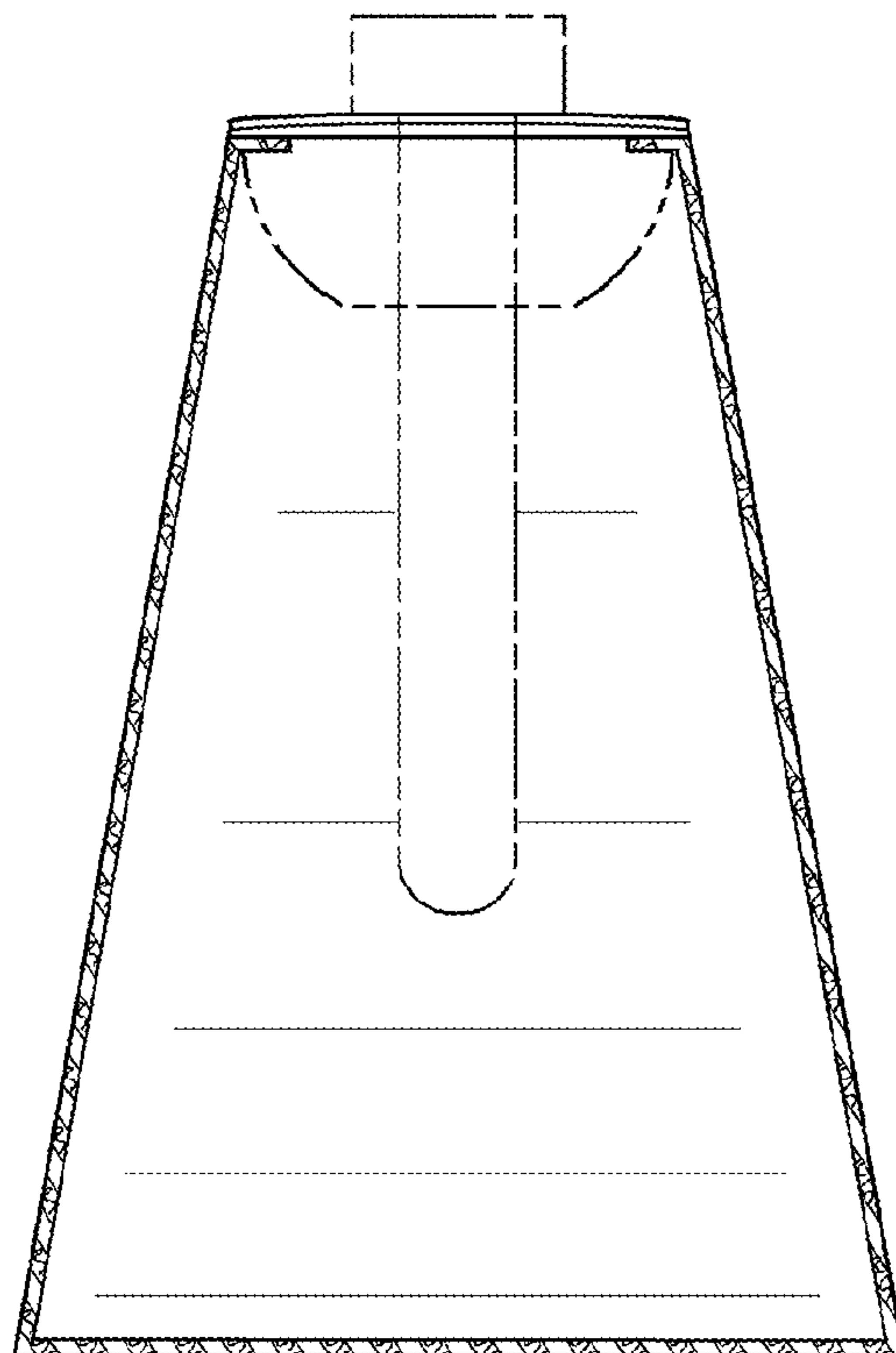

FIG. 7